

DEILI 22 1:10

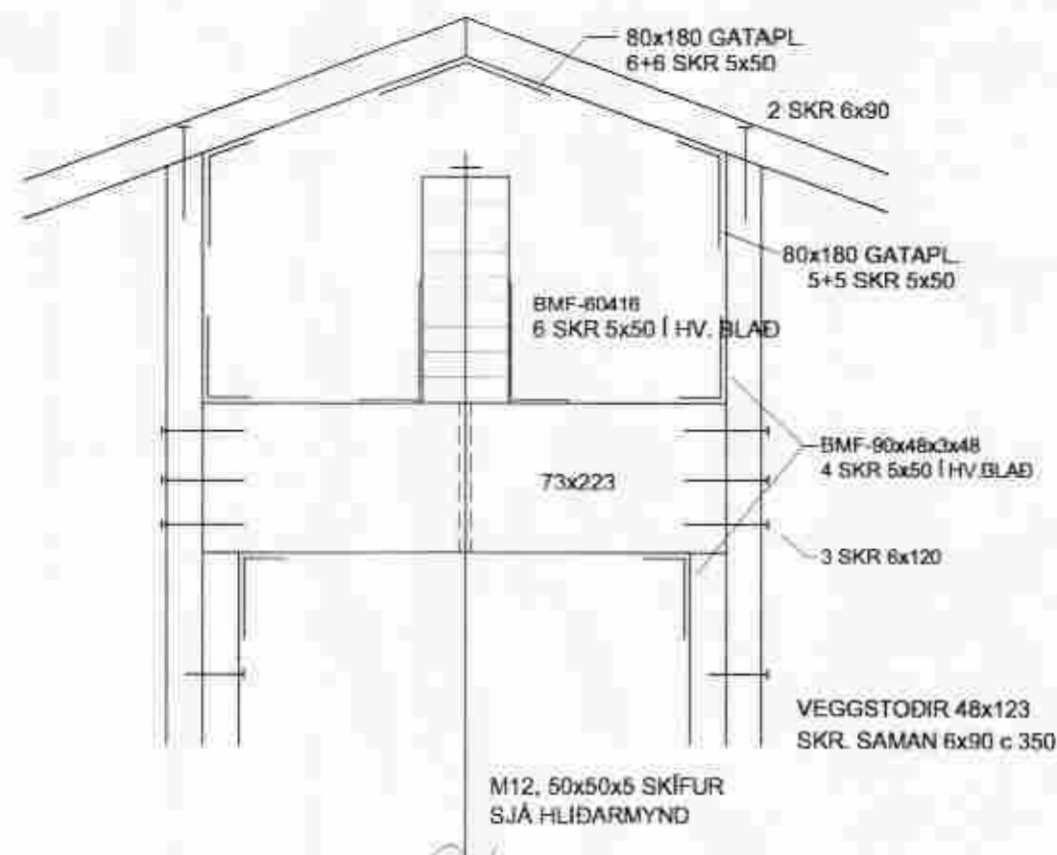

SNID 23 1:10

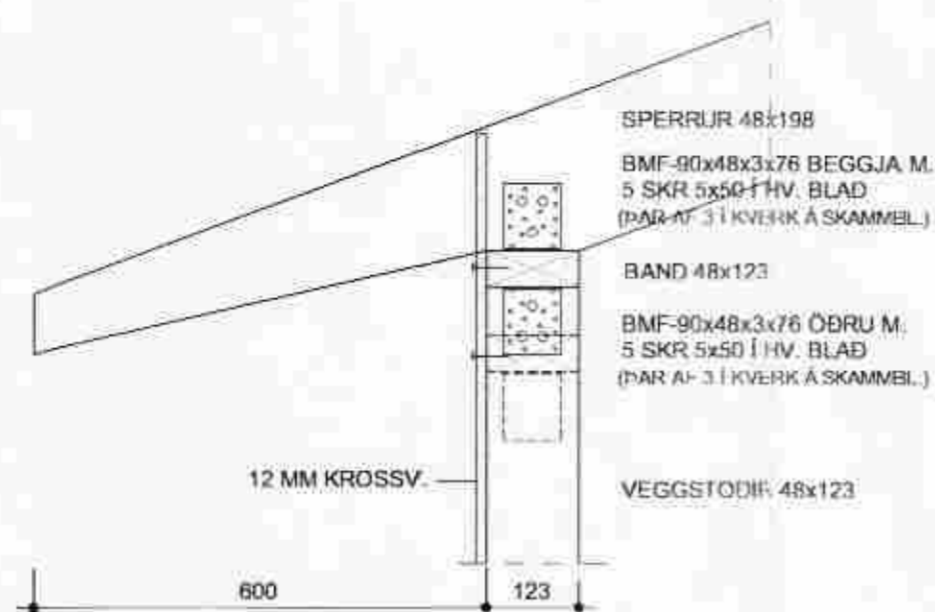

SNID 24 1:10



DEILI 27 1:10

FESTING Á 45° SPERRU VÍÐ MÆNIR



SNID 26 1:10

FESTING Á 45° SPERRU VÍÐ ÚTVEGGI



SNID 25 1:10

ÞAKKANTAR, SJÁ TEIKNINGU ARK.

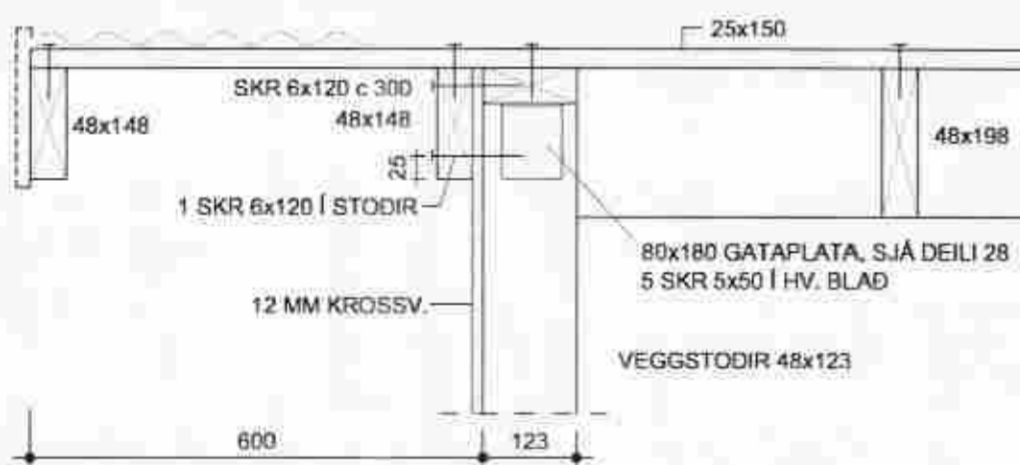

SNID A-A

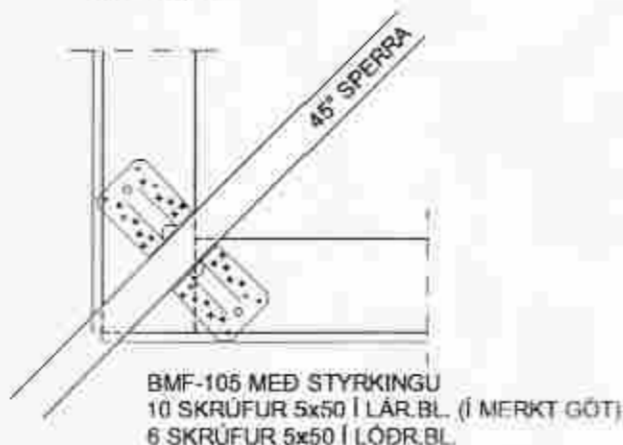

DEILI 30 1:10

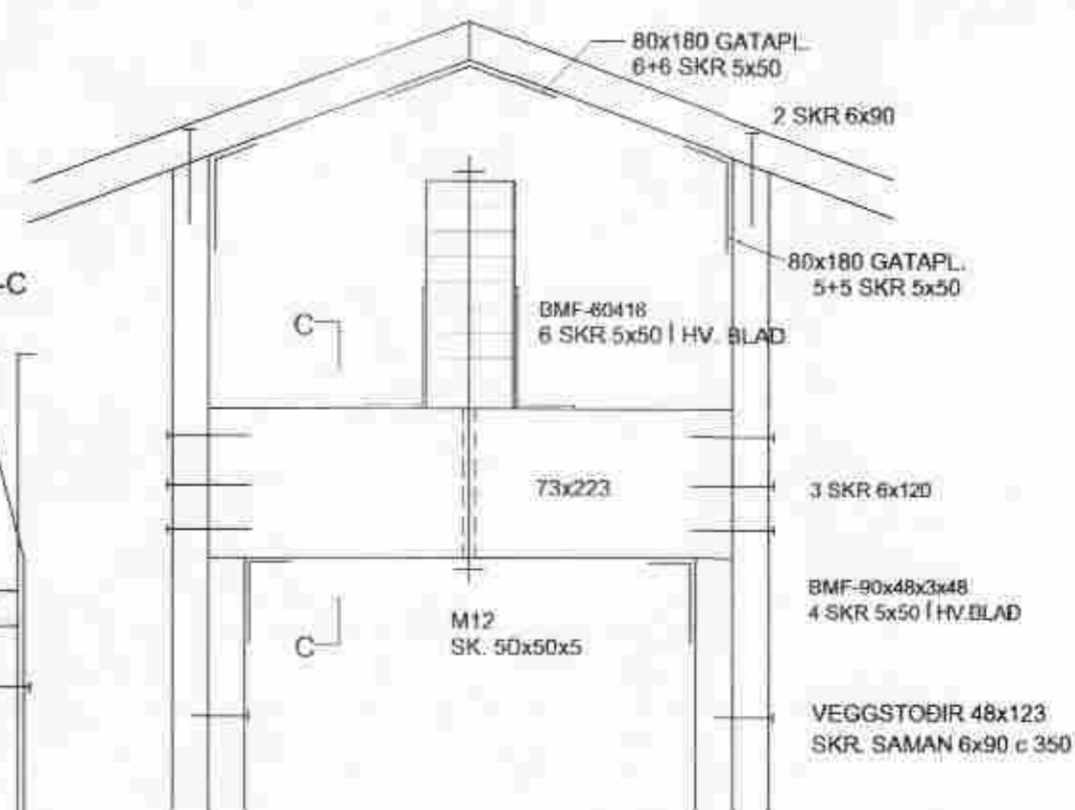

SNID C-C

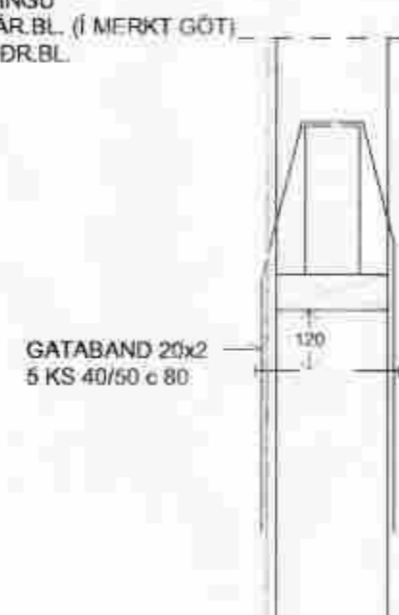

SNID 28 1:10

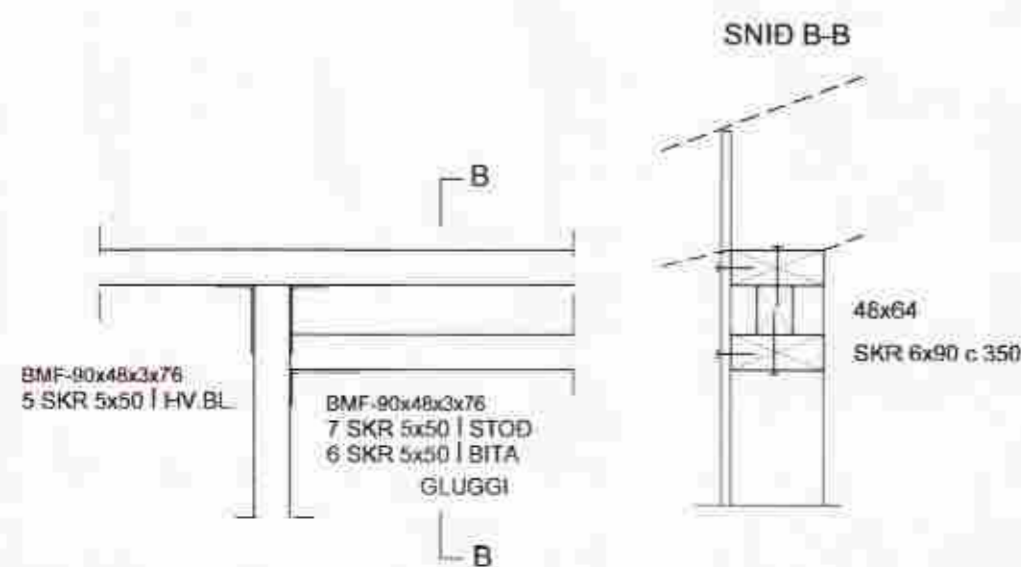

DEILI 29 1:10

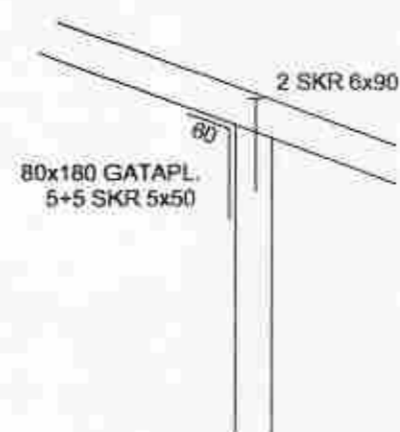

SKÝRINGAR, SJÁ BLAD 201  
 NEGLING Á KROSSVIÐ OG GÓLFPLÖTUM, SJÁ SKÝRINGAR.  
 NOTA SKAL BYGGINGARVINKLA FRÁ BMF.  
 KAMBSAUM OG SKRUFUR Í VINKLA FRÁ BMF.

KS = KAMBSAUMUR SKR = SKRUFUR

GESTAÐÚS VÍÐ ÁSBORGIR 30 GRÍMSNESI

BURDARVIRKI - SNID

DAÐSETNING	HAÐNAD	MKV	TEIKNING
01.08.2006	PG	1:10	206

PÉTUR I GUDMUNDSSON BYGGINGARTEKNIFRÆÐINGUR 200246 4069  
 VINNUSTOFA AUBBREKKU 6, 200 KÓPAVOGI  
 SÍMI 551-9940 863-5880 FAX 551-9945 p.g@mij.is

*TRK*  
 SAMRÆMINGARKITEKTS