

MÖTTUÐ  
 15. JUNI 2012  
 Guðni Þorsteinsson  
 Byggingarteknik og Skýring og Flóan.

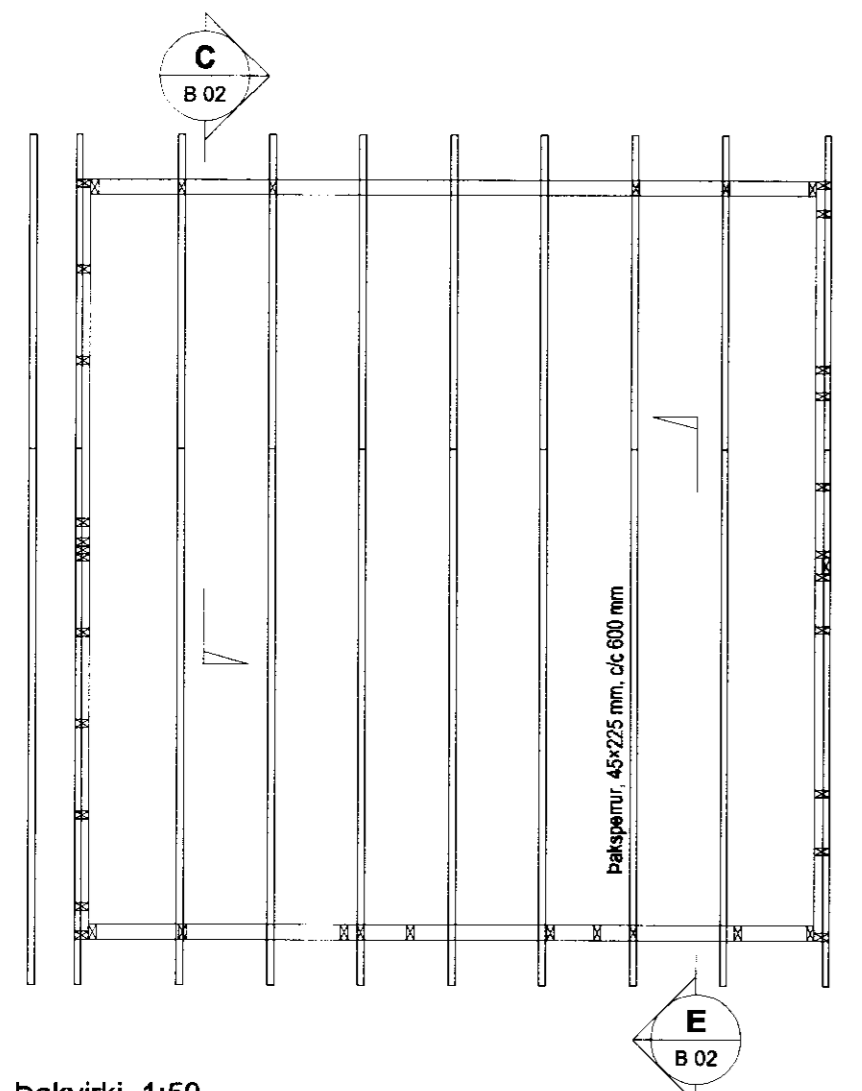

Bakvirki 1:50

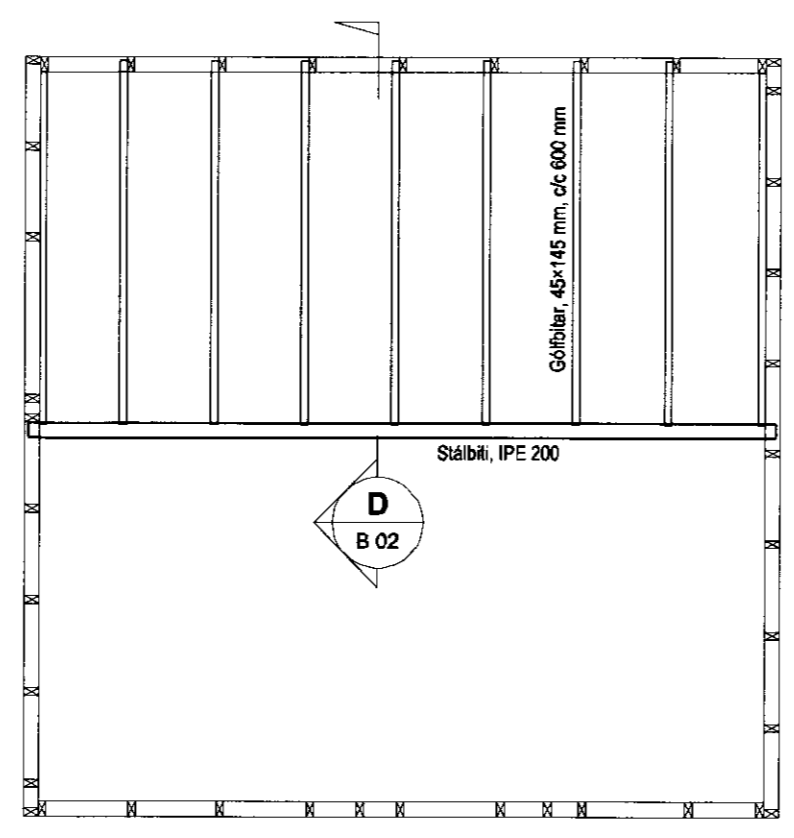

Milligólf 1:50

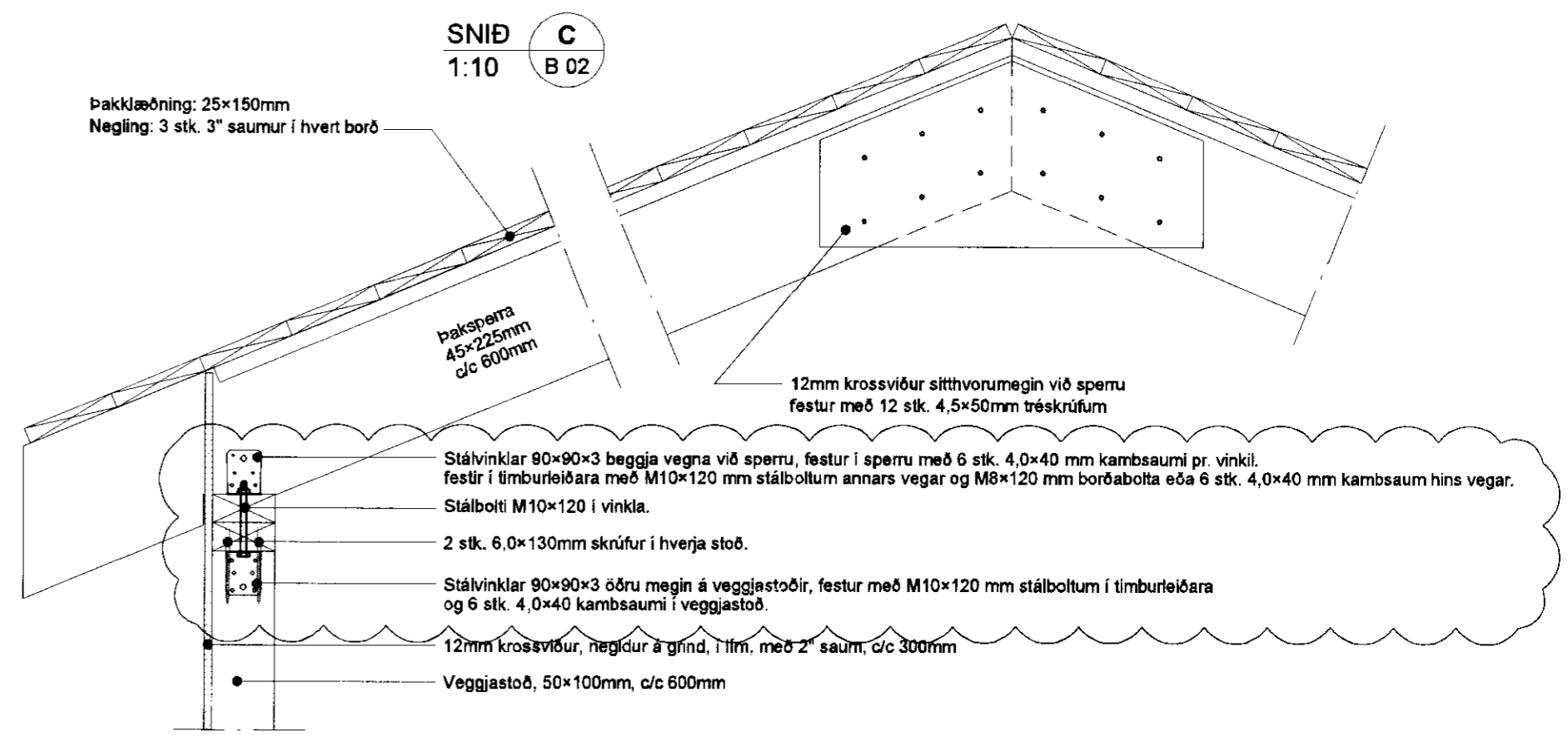

SNIB D B 02  
 1:10

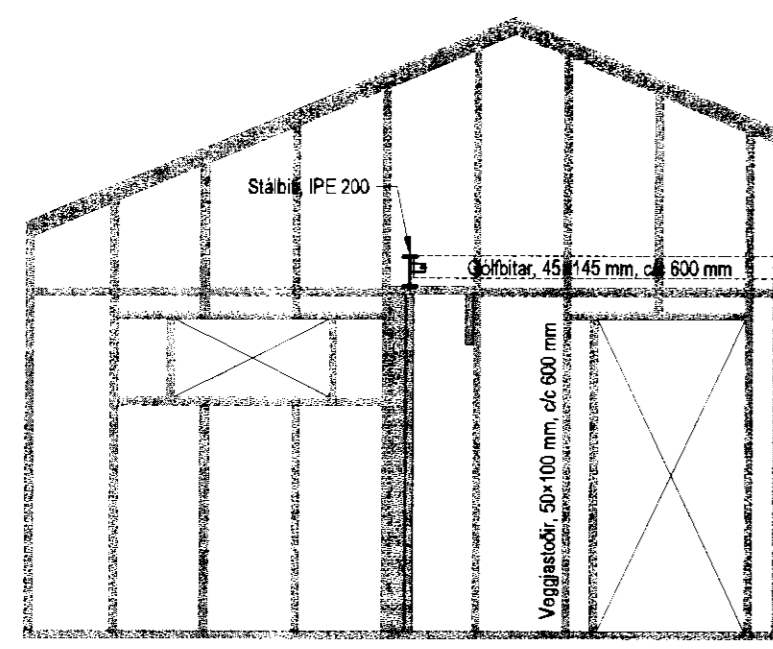

Veggjagrind, austur 1:50

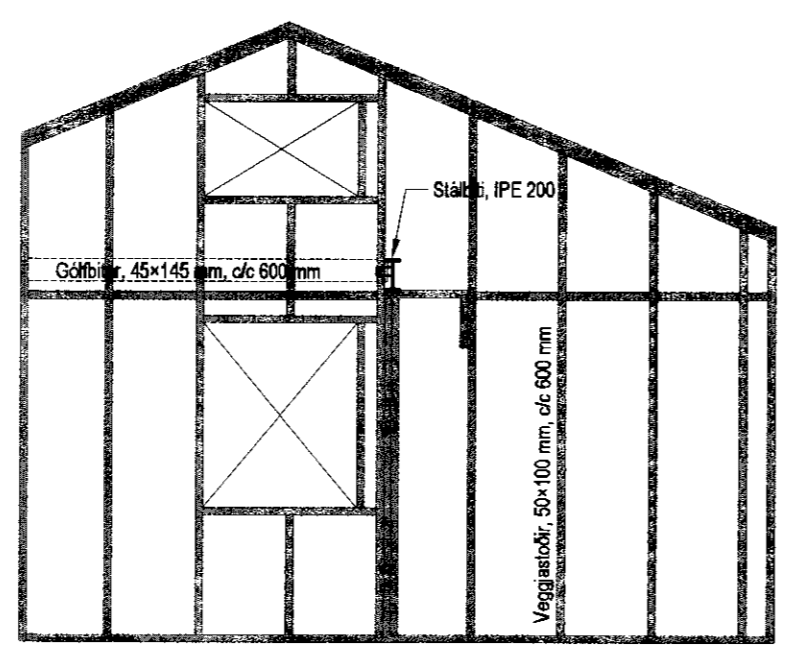

Veggjagrind, vestur 1:50

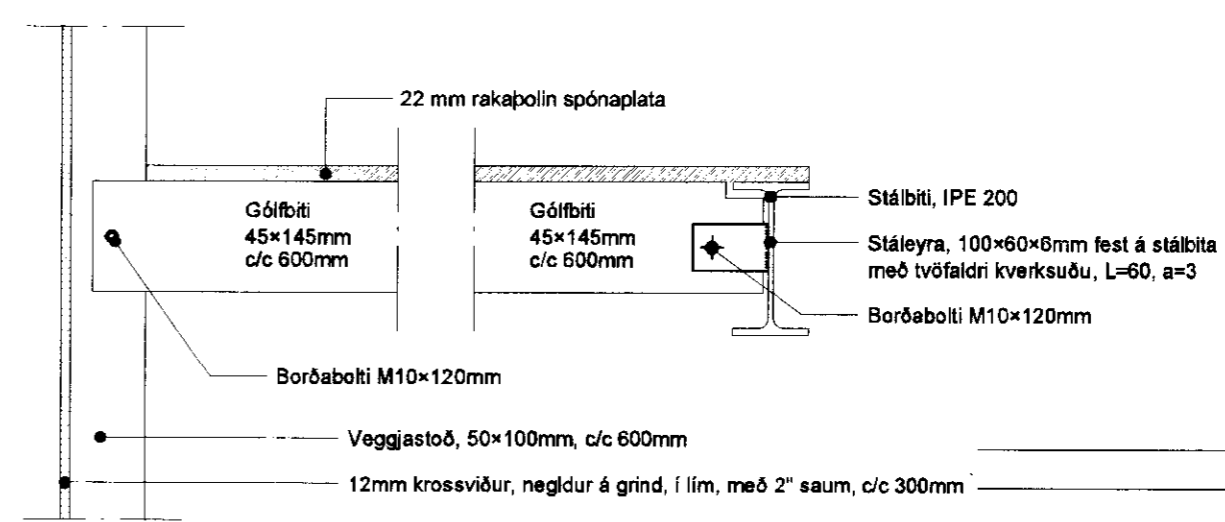

DEILI E B 02  
 1:10

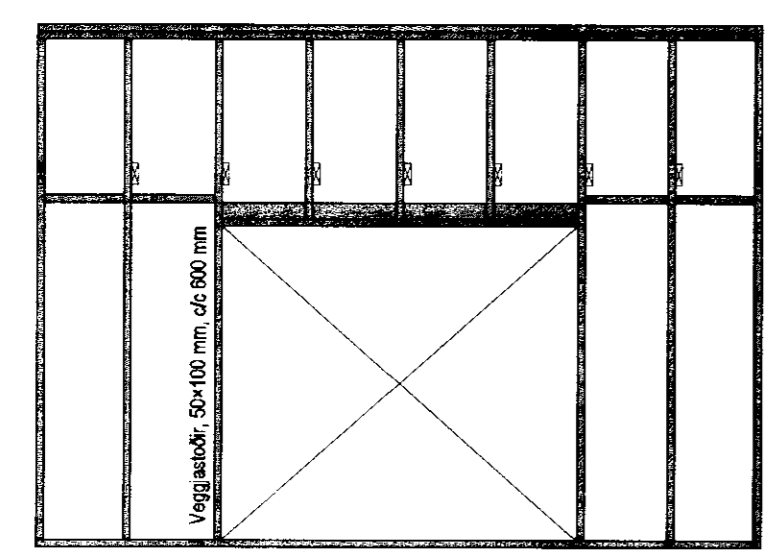

Veggjagrind, norður 1:50

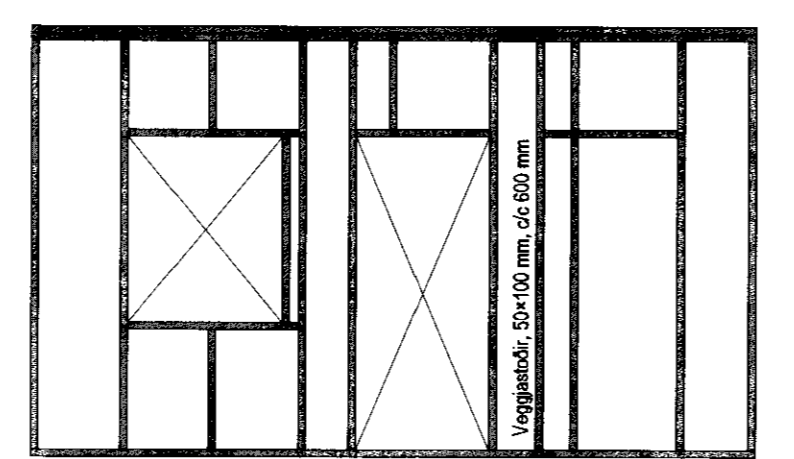

Veggjagrind, suður 1:50

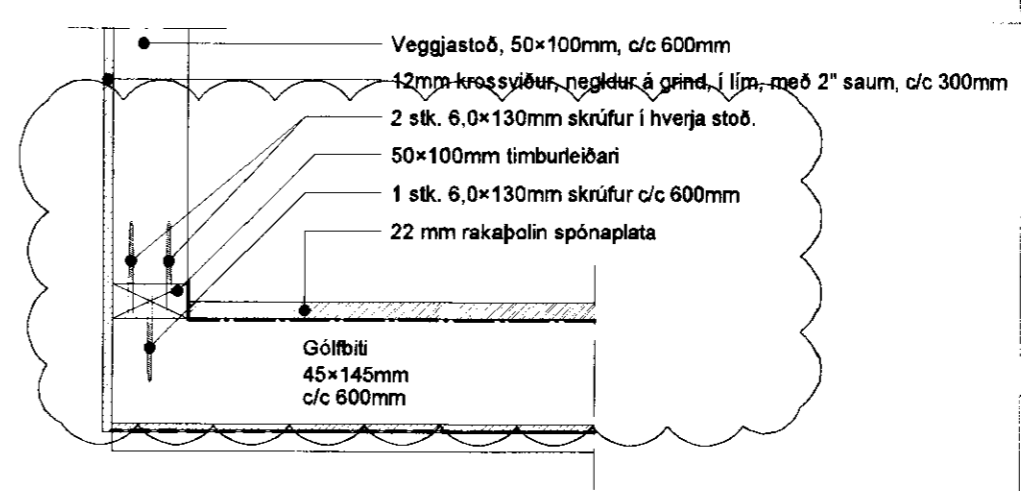

A 15.06.12 Festingar breytast BS/BG  
 Útg. Dags. Skýring Hannað/Yfirarið

15.6.12  
 Guðni Þorsteinsson  
**VSB**  
 VERKFRÆÐISTOFA  
 BÆJARHRAUN 20 · 220 HAFNARFJÖRÐUR · KENNIT. 710796-2899  
 vsb@vsb.is · Sími 585 8600 · Fax 585 8610 · www.vsb.is

Áritun sérhönnuðar  
 Björn Guðstafsson, kt. 180550-4889

Verkefni  
**HVAMMSVEGUR 12**  
**GRÍMSNES- OG GRAFNINGSHREPPI**  
 Verkhúti  
 Burðarvirki  
 Þakvirki, milligólf og veggjagrindur  
 Grunnmyndir, ásýndir og snið

Hannað BS	Teiknað BS	Yfirarið BG	Kvarði 1:50 / 1:10 / A2	Síða -
Dags. 30.12.2012	Verkefni	Teikning B 02	Útgáfa	-