

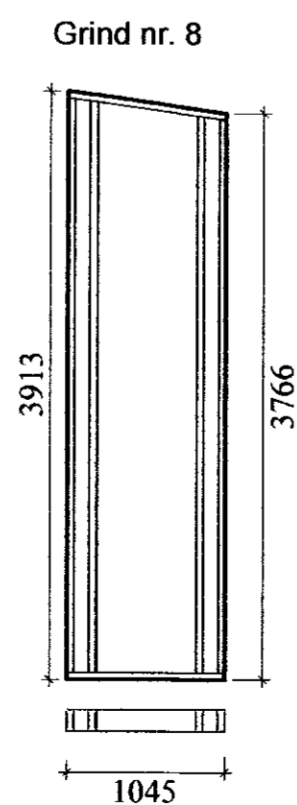

GRINDUR 1:50

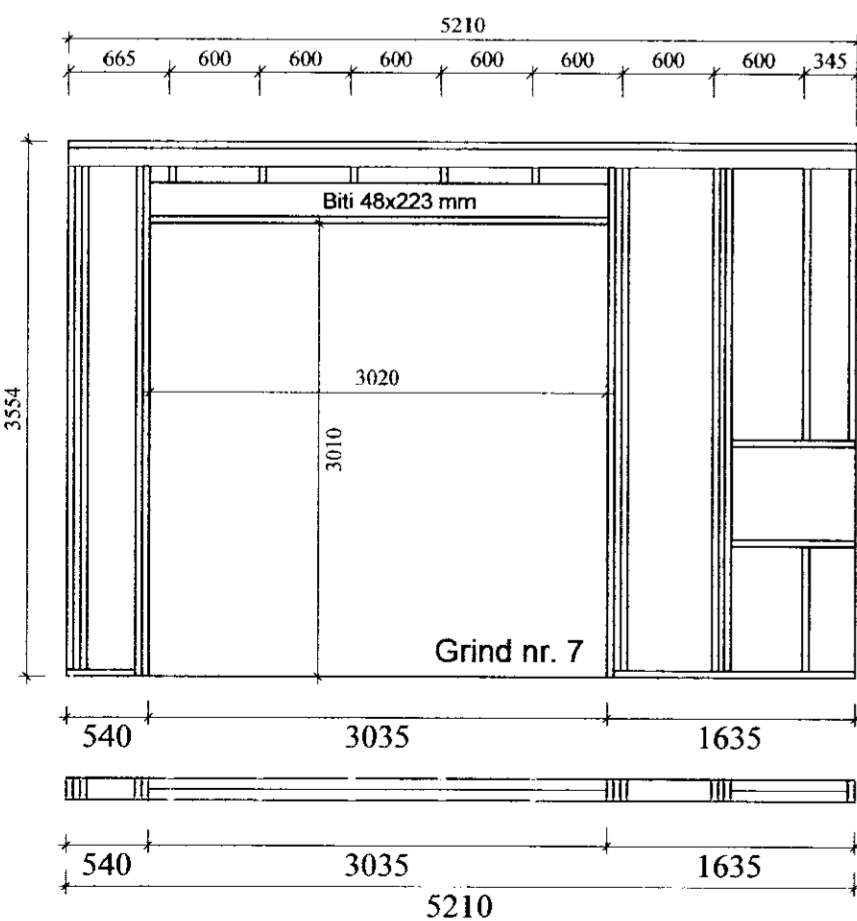
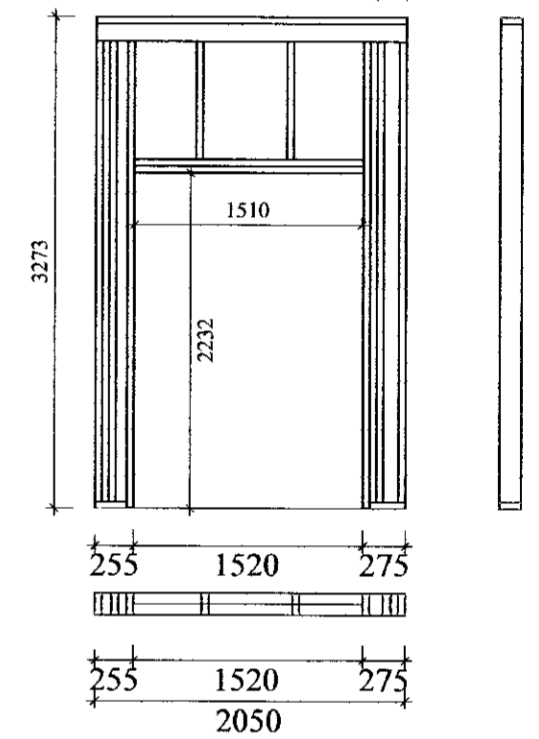
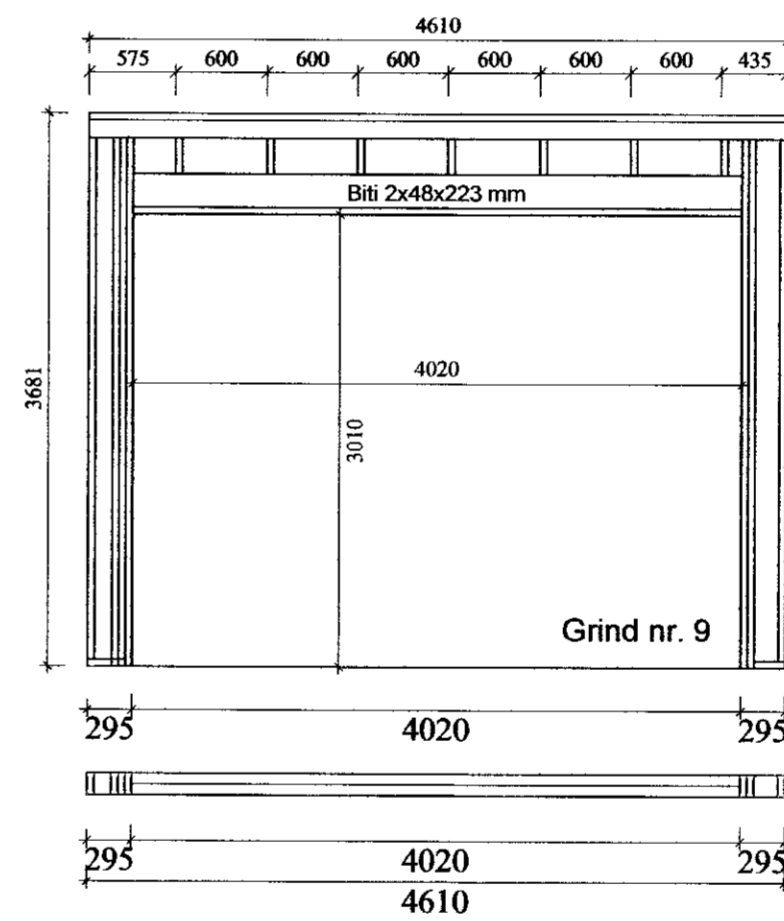
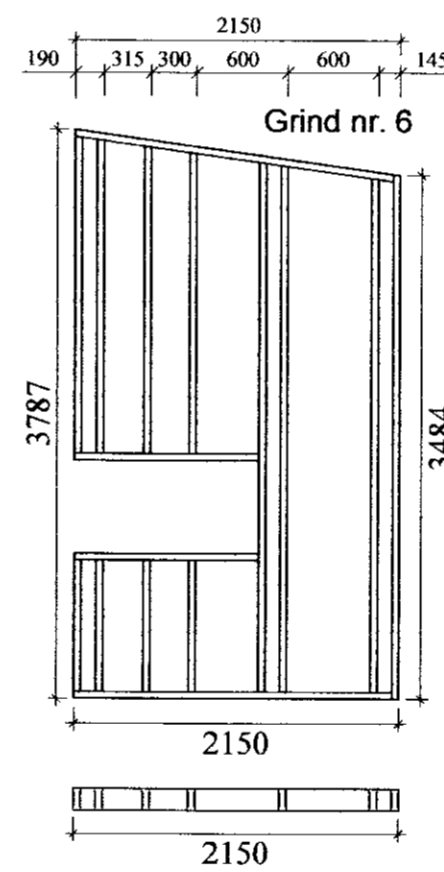
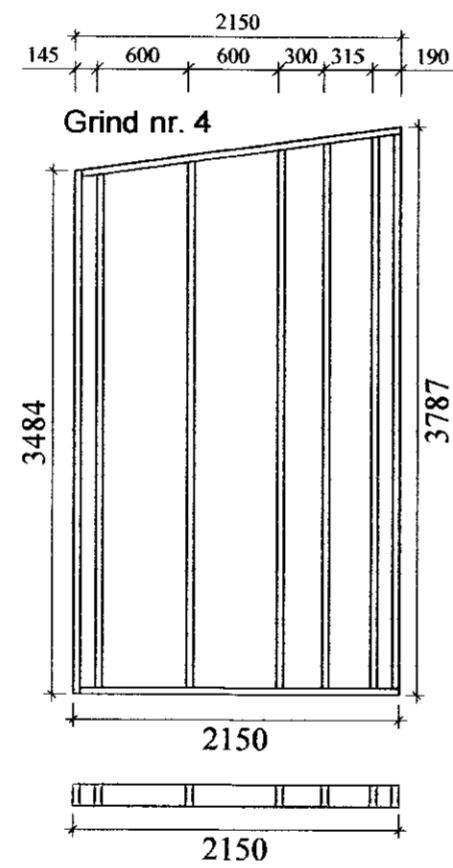
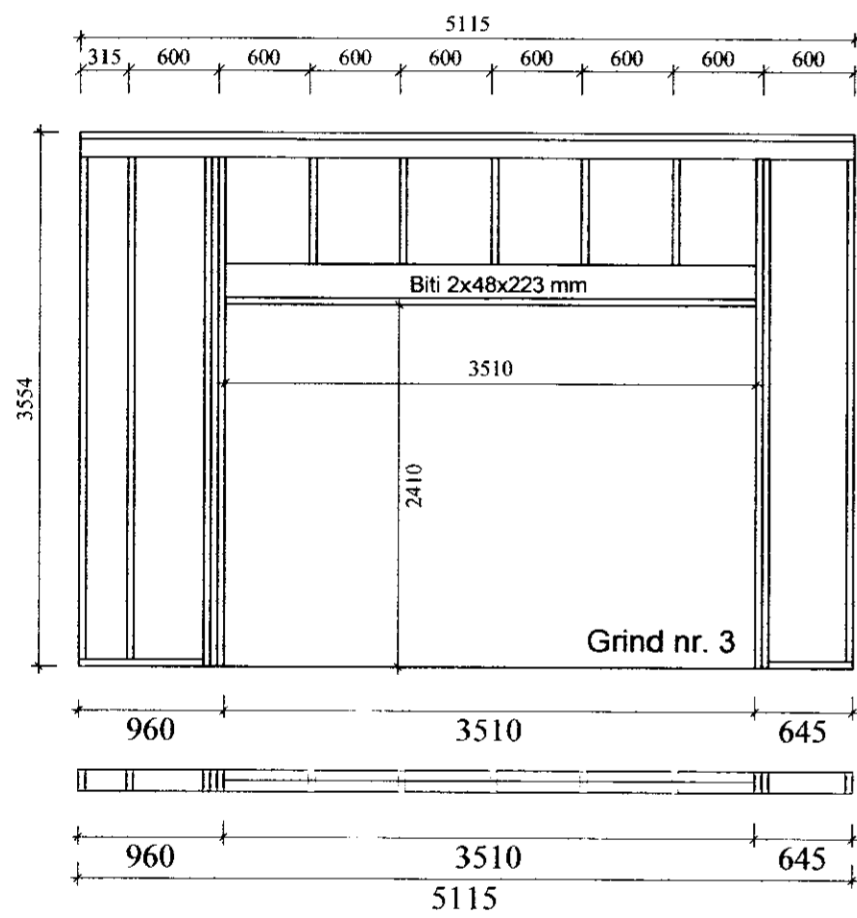
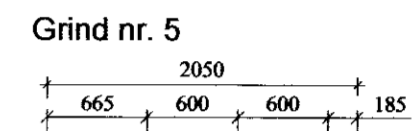

SKÝRINGAR

Grind 45x145 m/m 600 mm er í útveggjum, 50x100mm í innveggjum. Timburstærðir eru í mm. Grindaefni sé í gæðaflokki T10 (K18) eða betra. Allt grindaefni skal þykktarhefja á kanta. Allt ónefnt grindaefni í útveggjum er 45x145 mm eða 48x148 mm.

Útveggjagrindur klæðist að utan með 9mm krossviði, til vindstífgar og sem vindvörn. Neglist með 28x60 mm nöglum m/m 150 mm, (2" galv. m/m 150). Undir boltarær, sem herðast að tré, komi skifur 40x40x4mm.

Dags.	Breytingar	Nr.	Nafn
 meter teiknistofa ehf Þverholt 3, 270 Mosfellsbær			
Sími: 5678922, Gsm: 8940059 meter@meter.is, www.meter.is		ÁRITUN SAMRÆMINGARHÖNNUNAR:	
SOGSBAKKI 32, GRIMSNES OG GRAFNINGSHREPP			
GRIND 2 - GRIND 10 OG SKÝRINGAR			
TÖLVUSKRÁ 454-801-SOGSBAKKI 32	HANNAÐ FÓ	TEIKNAD FÓ	YFIRFARIÐ FÓ
SAMÞYKKT Friðrik Ólafsson 2305592459	TEIKNING NR. 454-B04	MKV. 1:50	ÓTGÁFA 01
DAGS. 10.10.2012		VERK NR. 454	