

MÓTTEKIÐ

14 OKT. 2008

Byggingafultrúi uppvs. Árnæssýslu og Flóahfr.

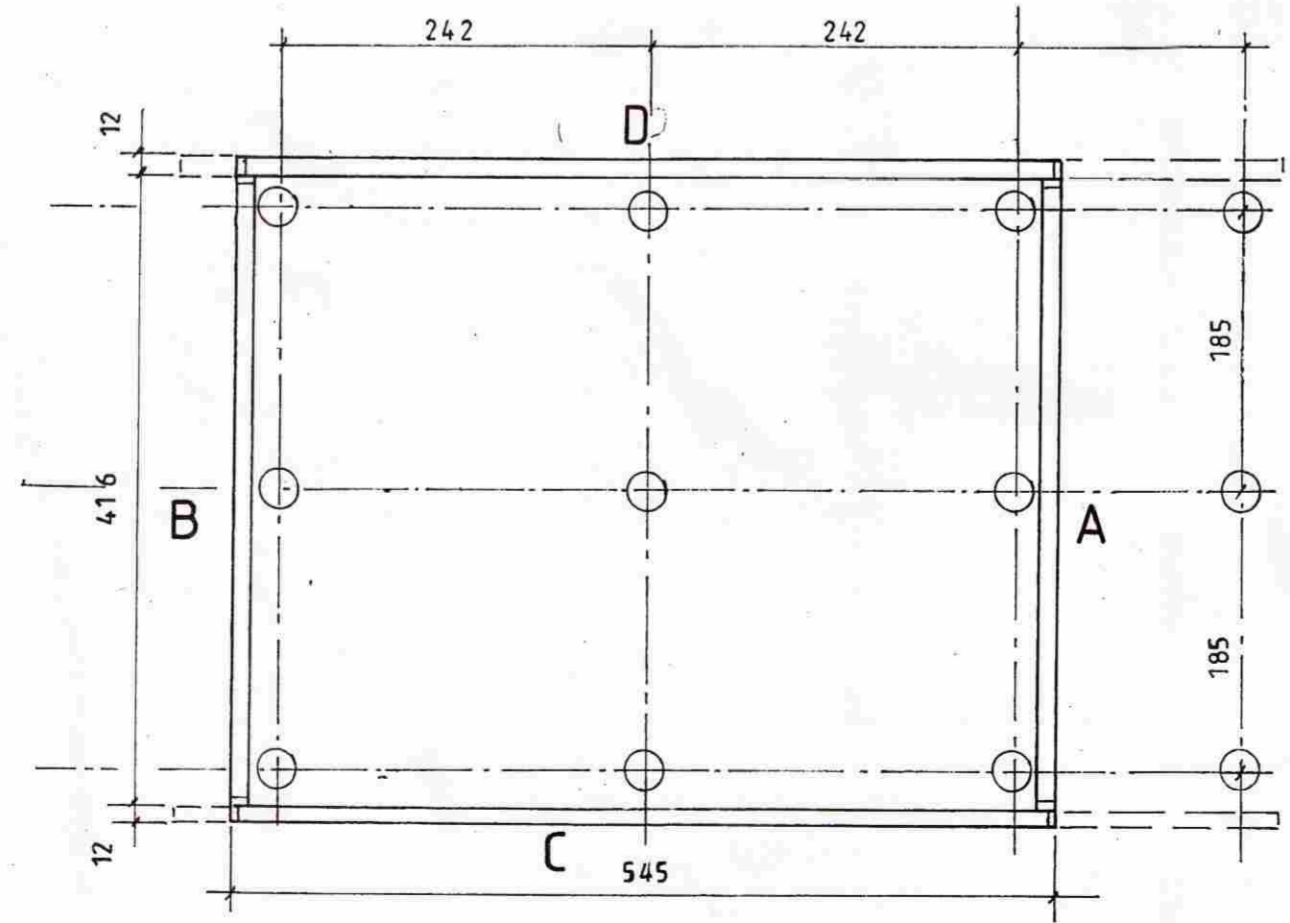
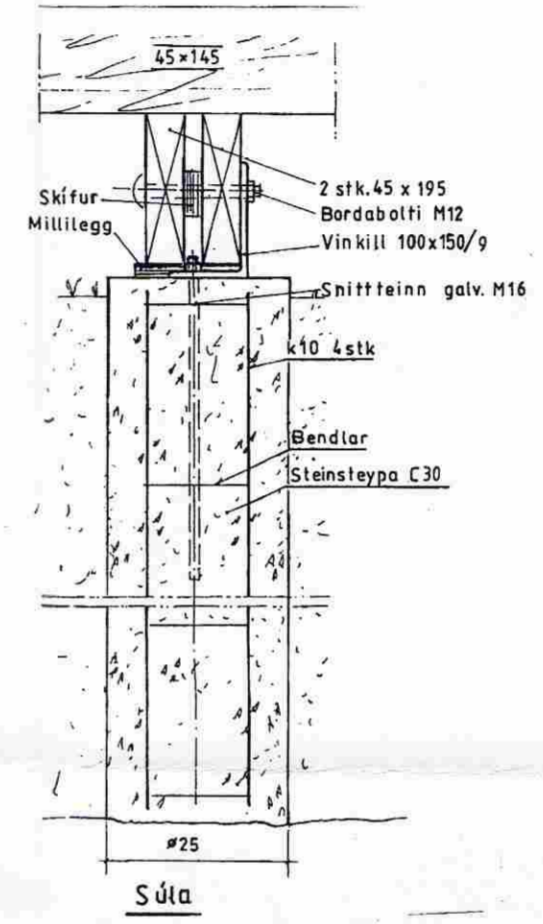
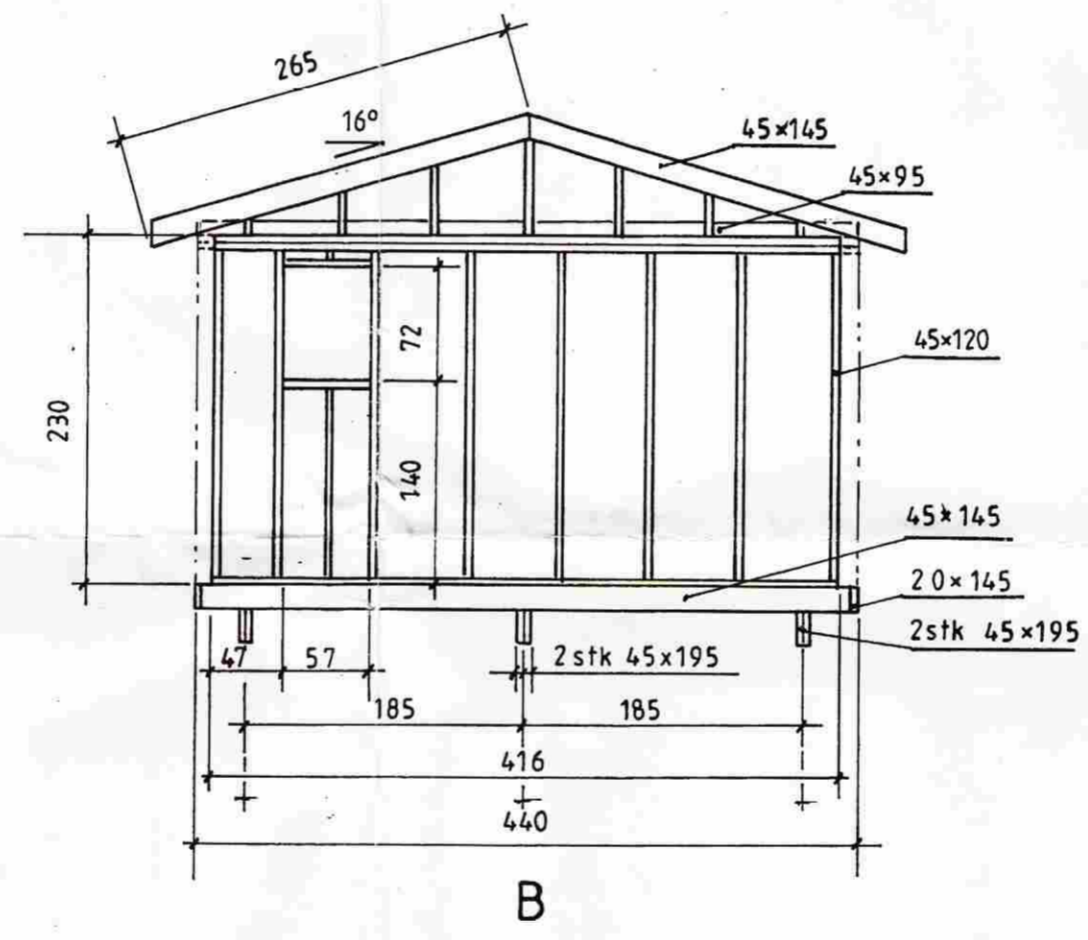
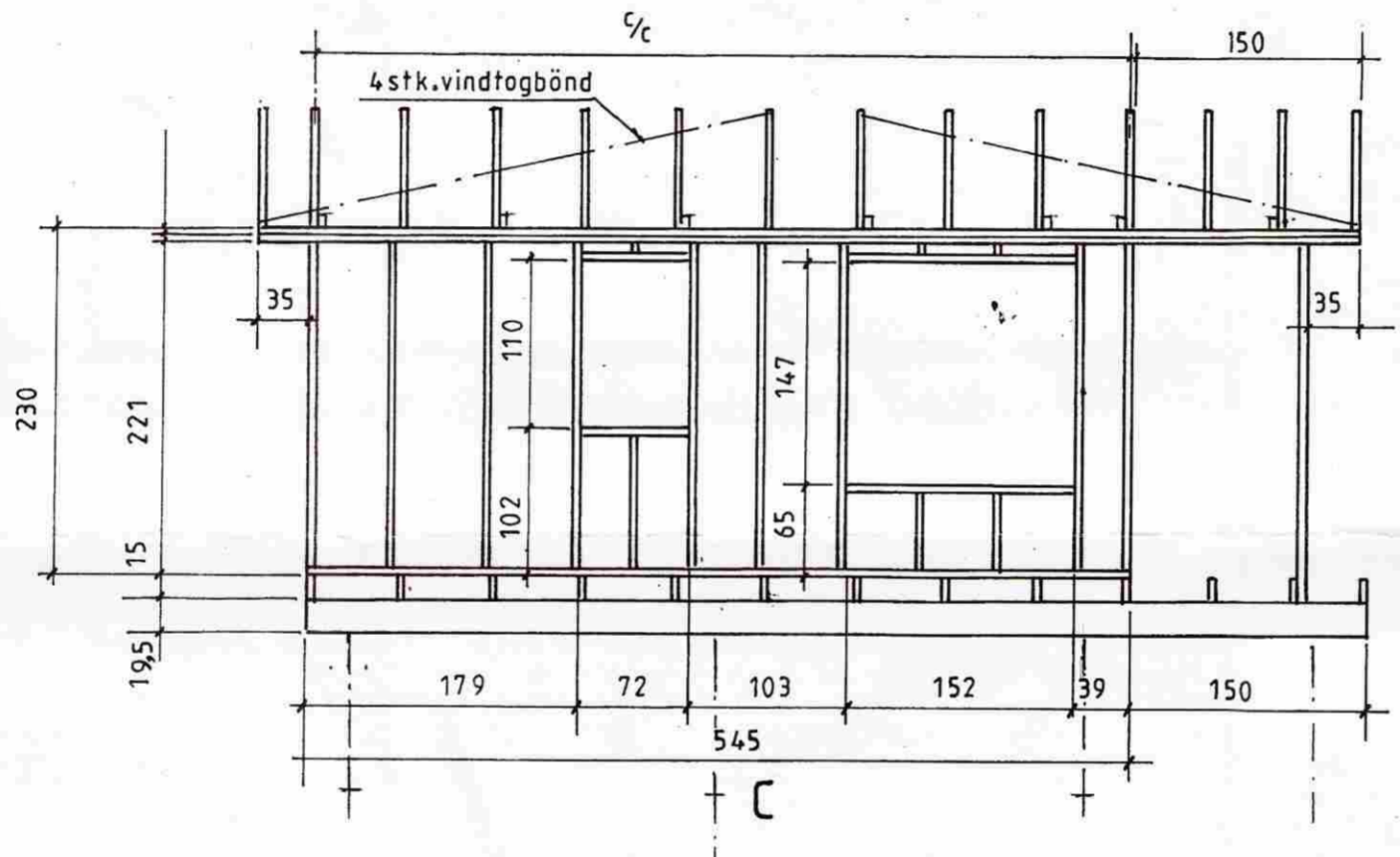
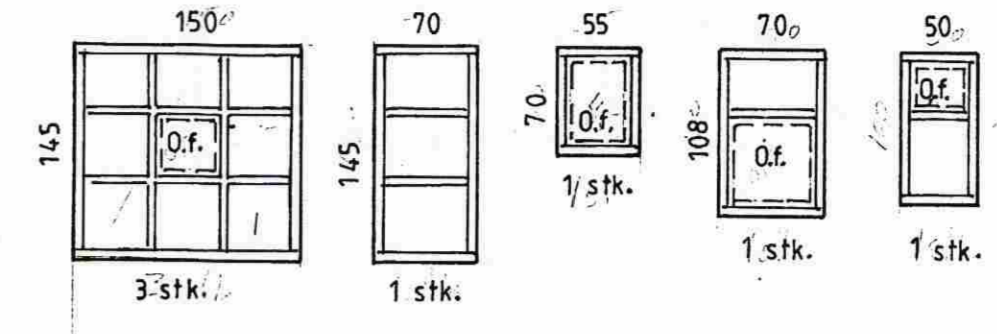
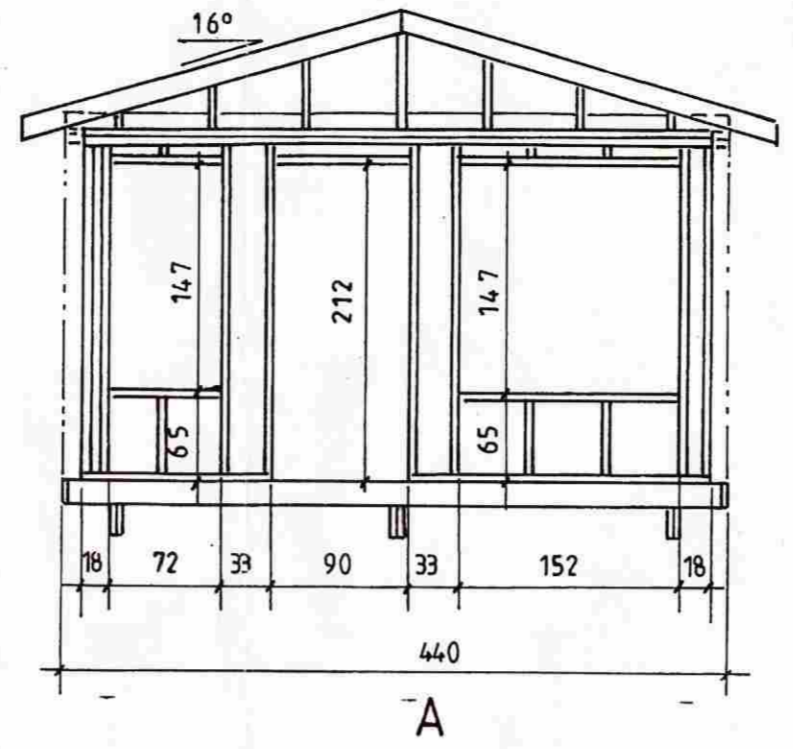
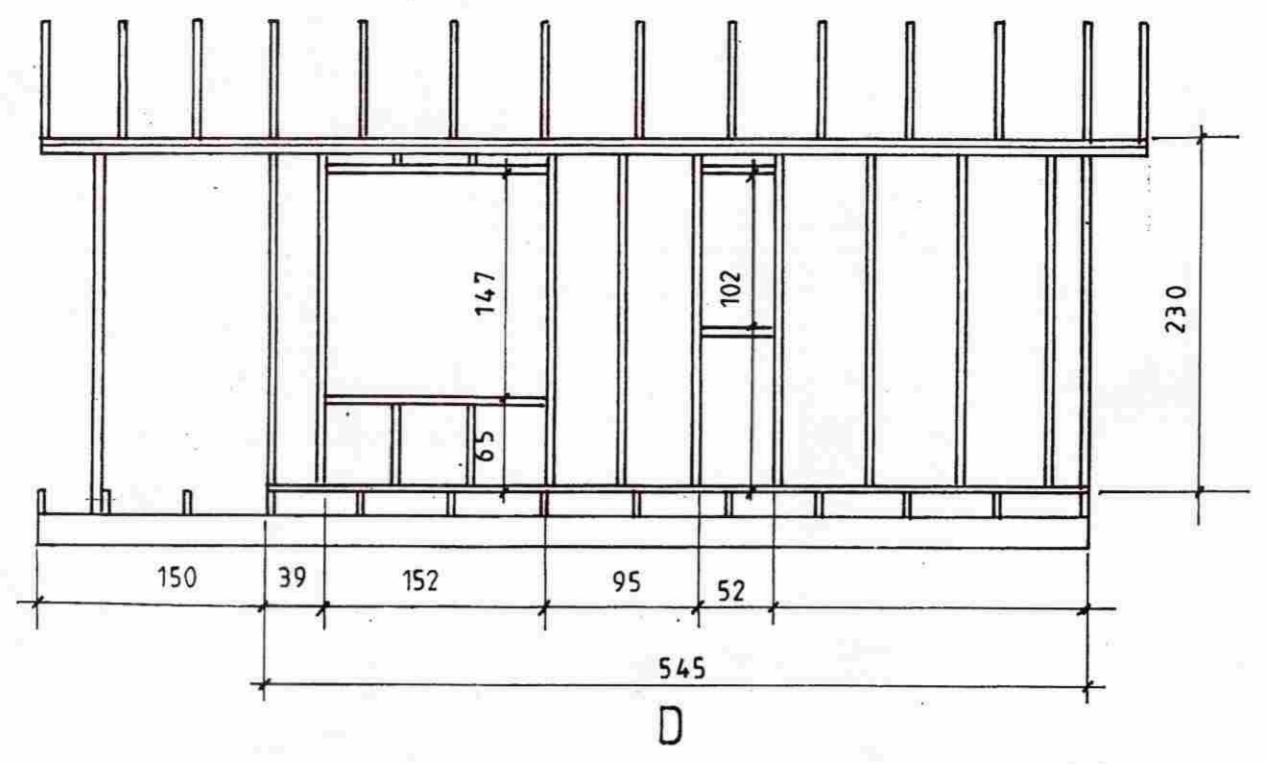

Mkv.: 1:50	Geymsla í landi, Þórisstaða Grimsness og Grafningshreppi	TEIKNIVANGUR
Dags. sept. '08	Árnæssýslu. Lóð nr. 64 við Mosaríma stærd 10,000 m ²	
Nr. Gey 116-02	Eigandi: Jón S.R. Pálmason kt 301244-2079	<i>[Signature]</i> 270733-2559
	Grindur og gluggar 25 m ² Geymsla. Burðarvirki	<i>[Signature]</i> 201032-4829