

Nr 1

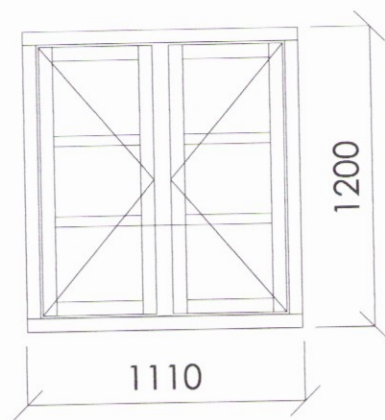

Nr 2

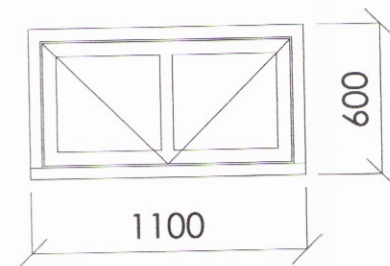

NR 3

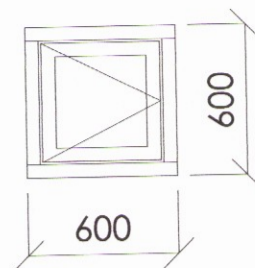

NR 4

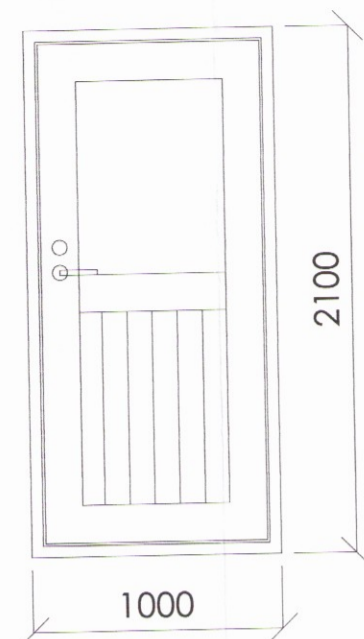

NR 5

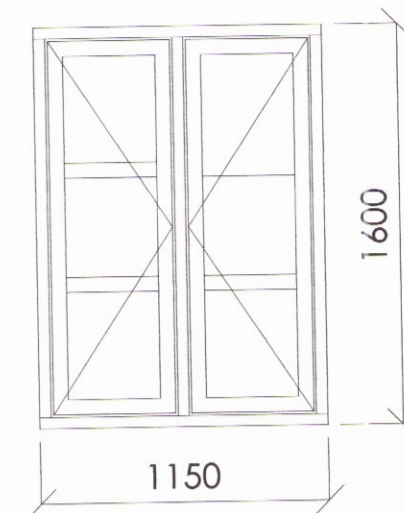

NR 6

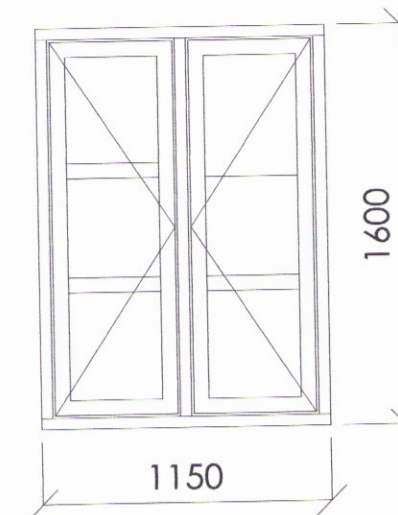

NR 7

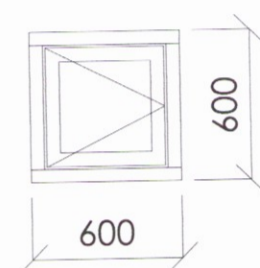

MKV 1:40

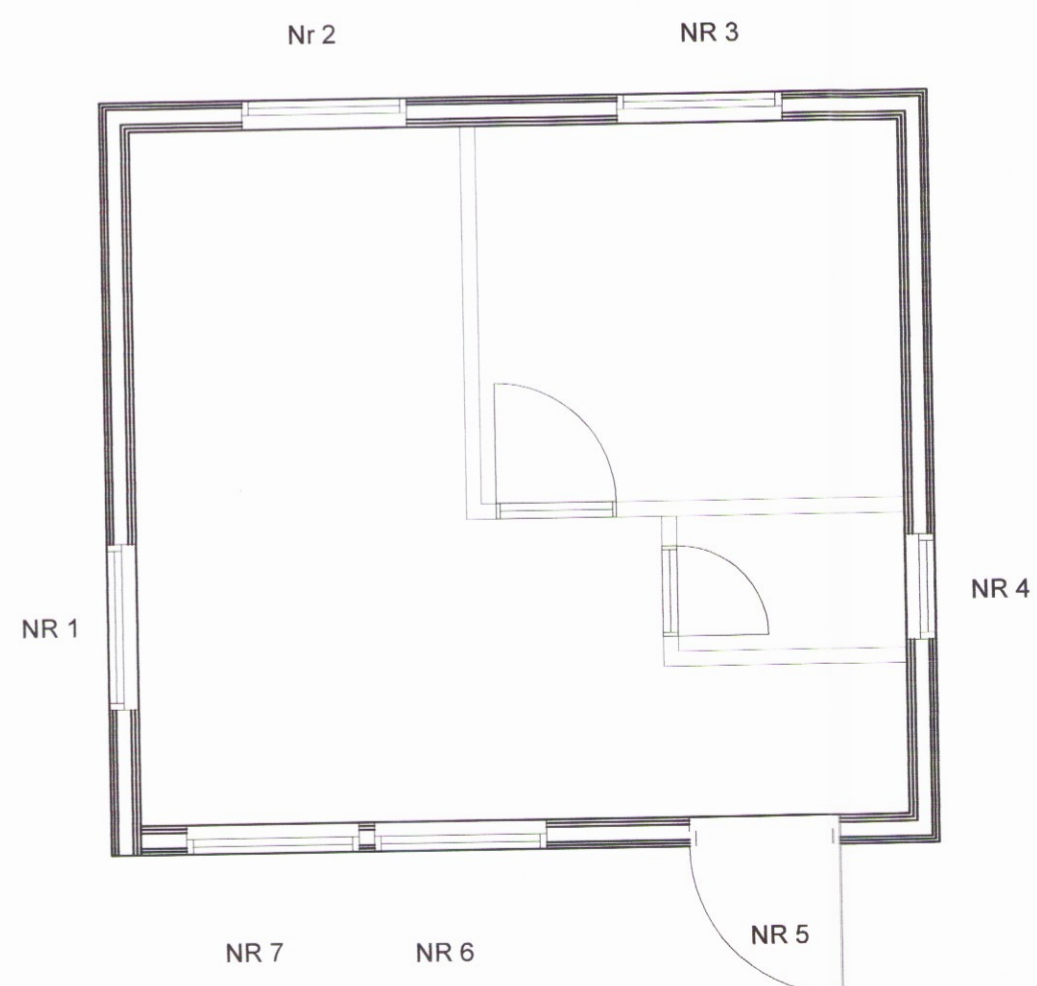

Grunnmynd-Yfirlit

M= 1:50

Gluggar:

Sannreyna skal öll mál á staðnum áður en gluggar eru smíðaðir.

Allir gluggarnir standast kröfur um brunaútanga.

Öll mál eru í mm