

Grind nr. 16

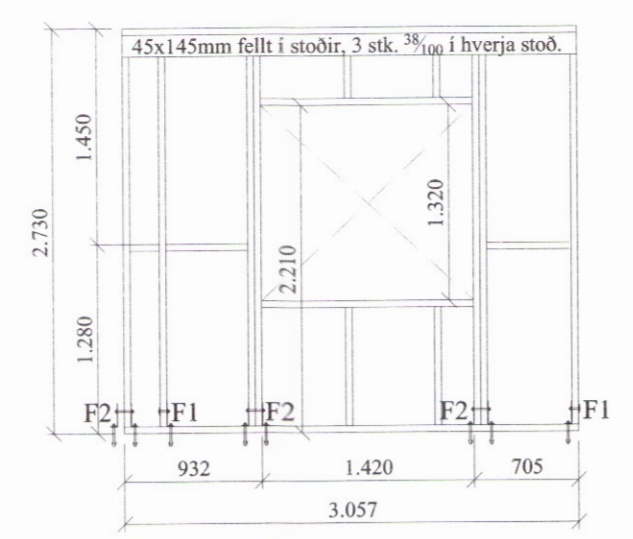

Grind nr. 15

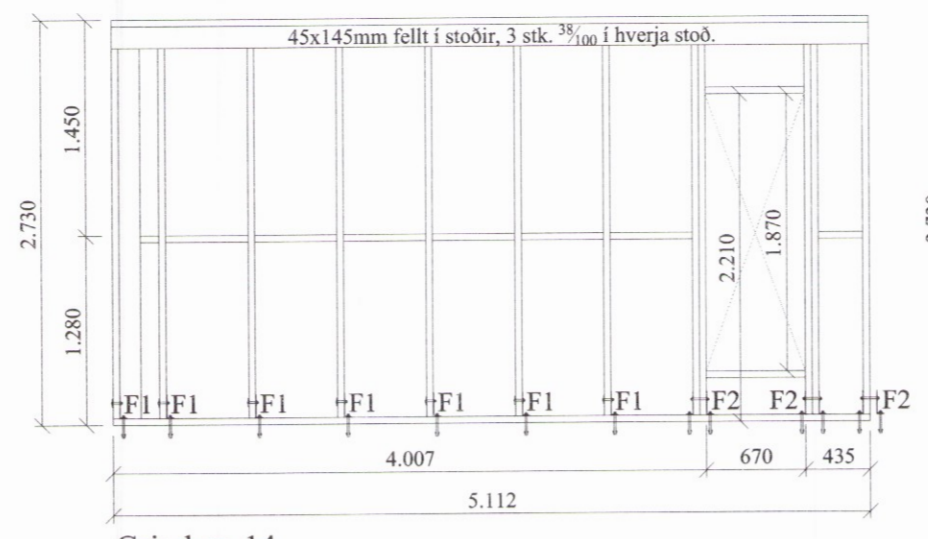

Grind nr. 14

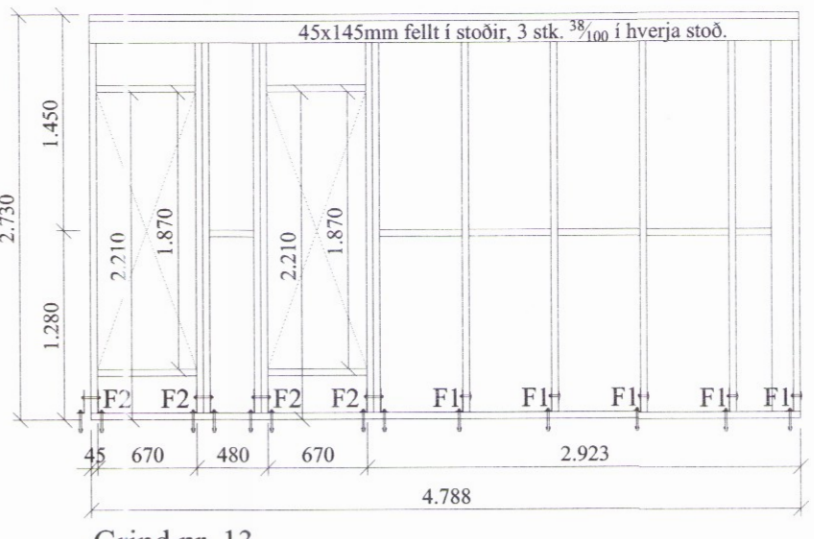

Grind nr. 13

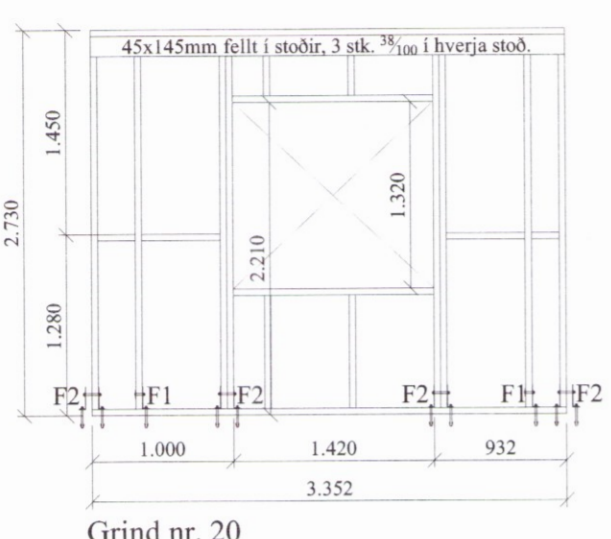

Grind nr. 20

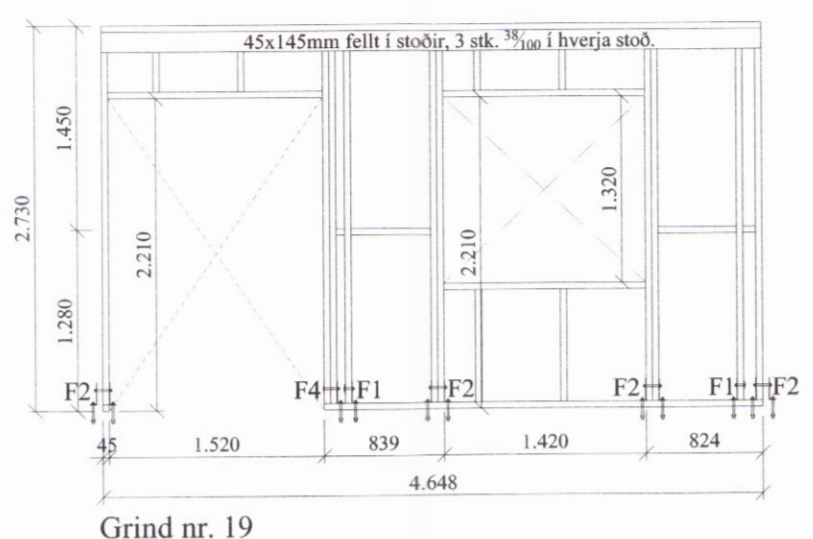

Grind nr. 19

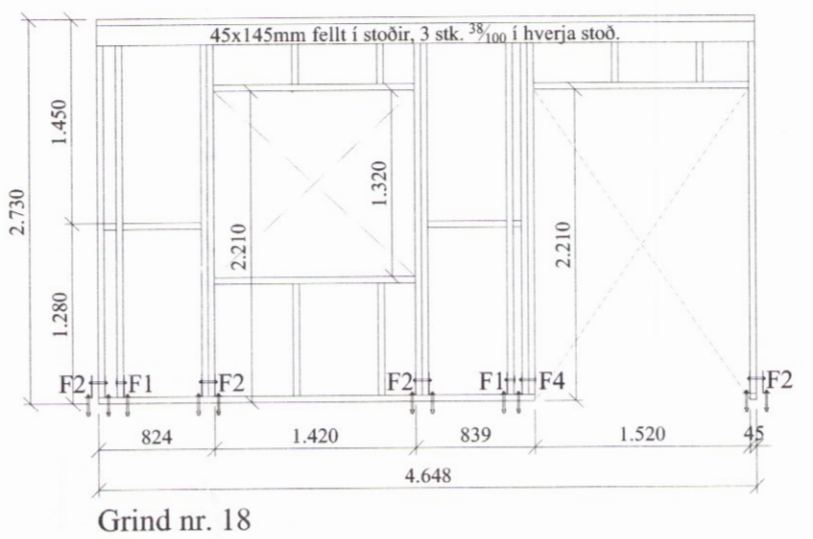

Grind nr. 18

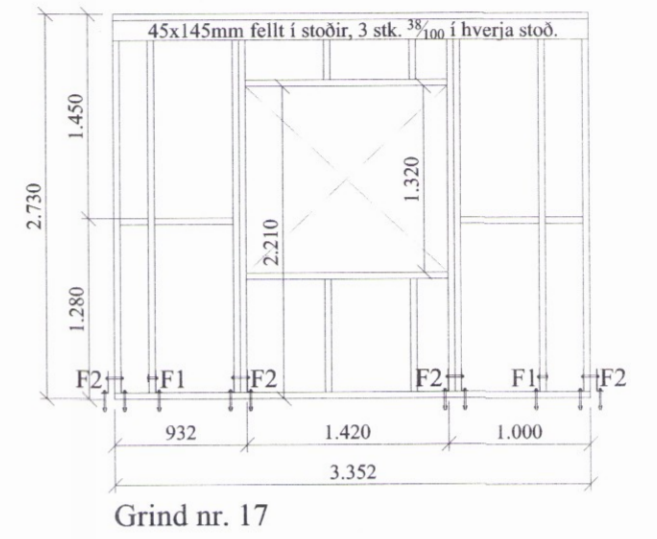

Grind nr. 17

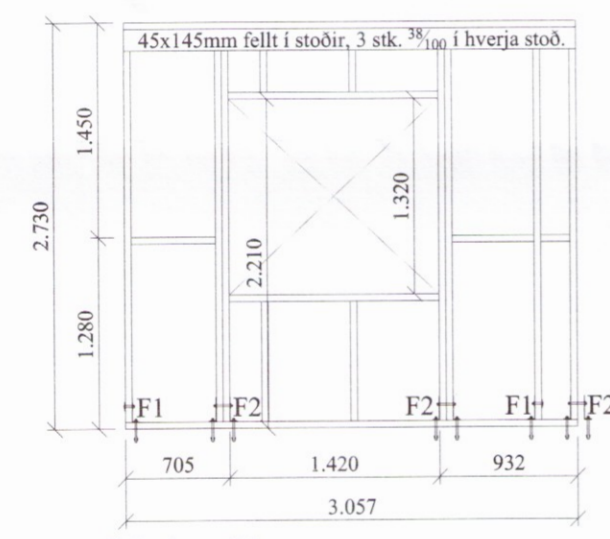

Grind nr. 24

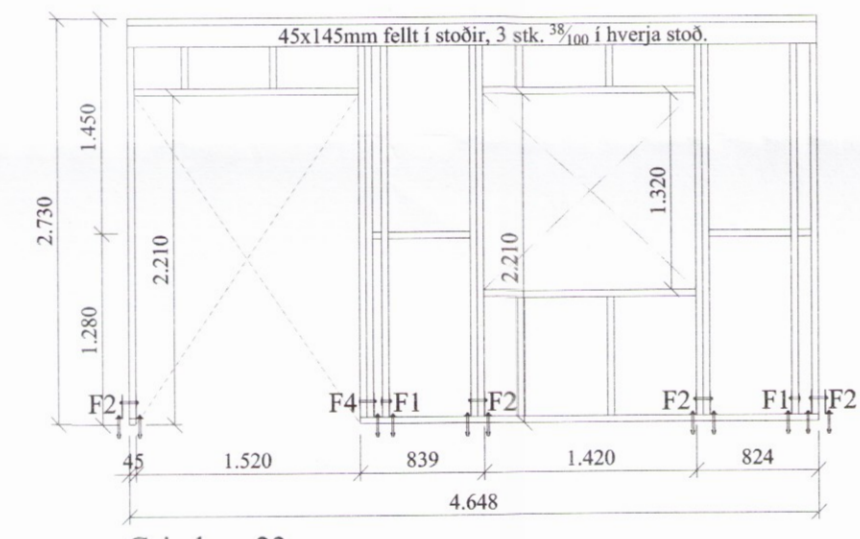

Grind nr. 23

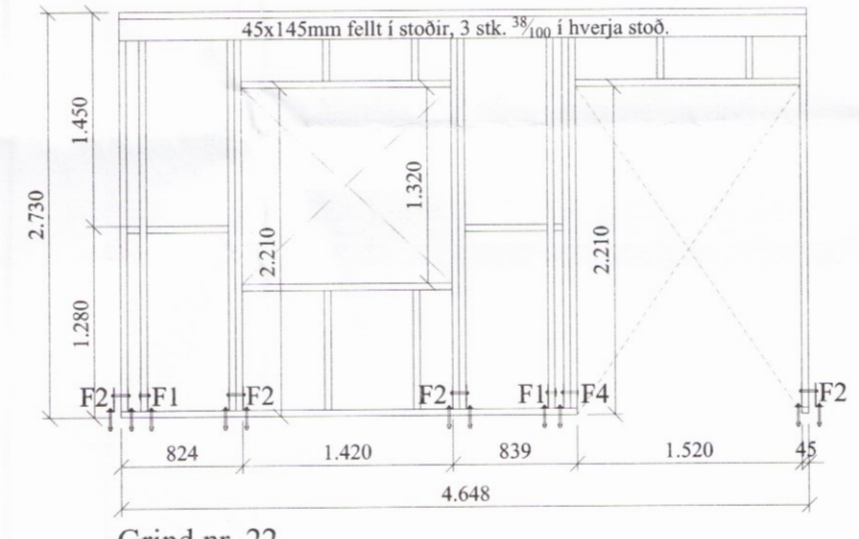

Grind nr. 22

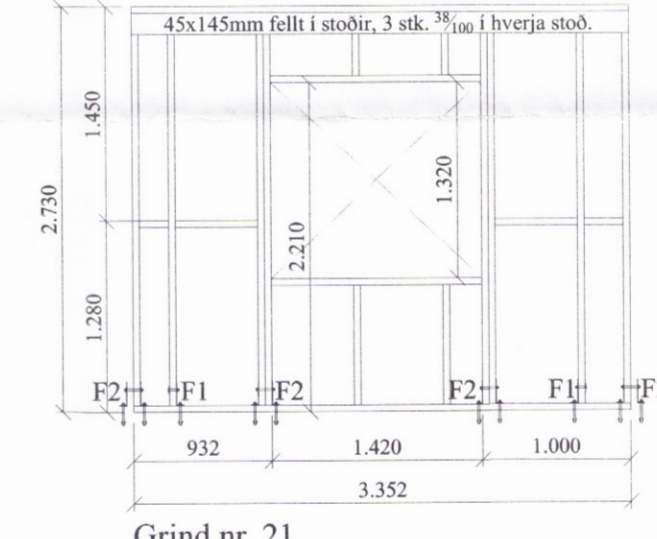

Grind nr. 21

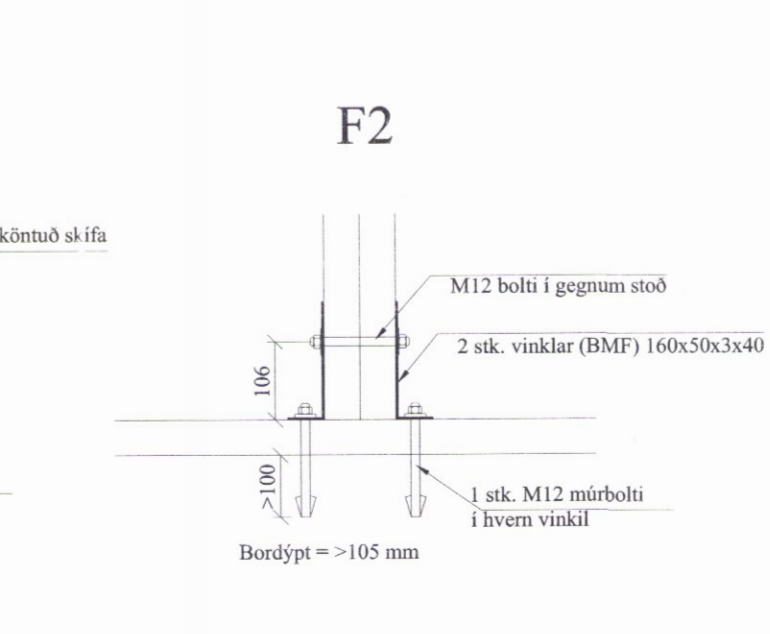
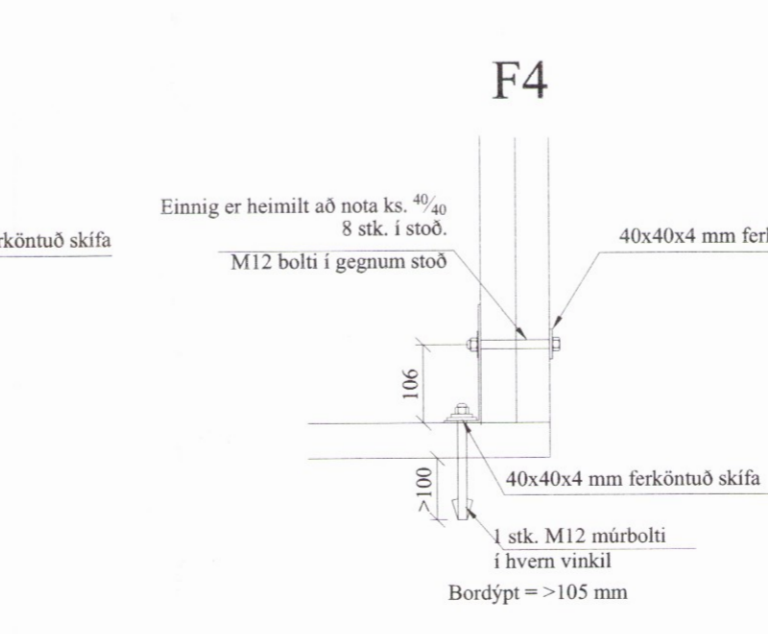
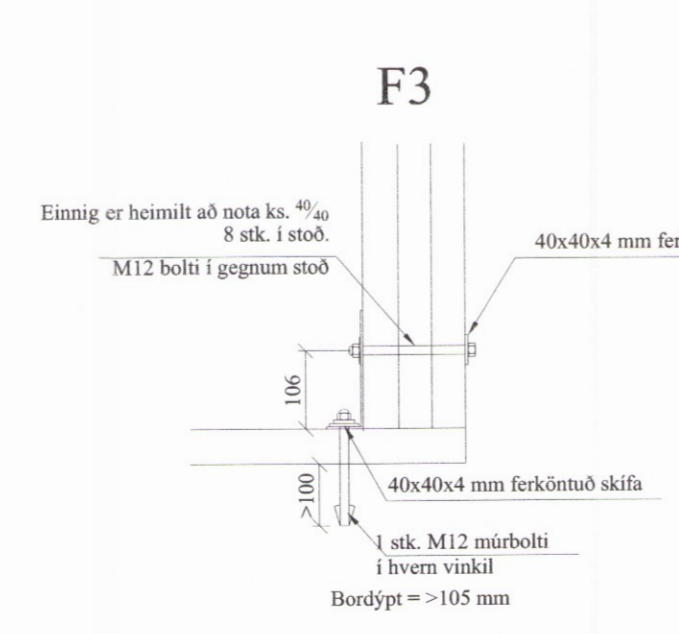
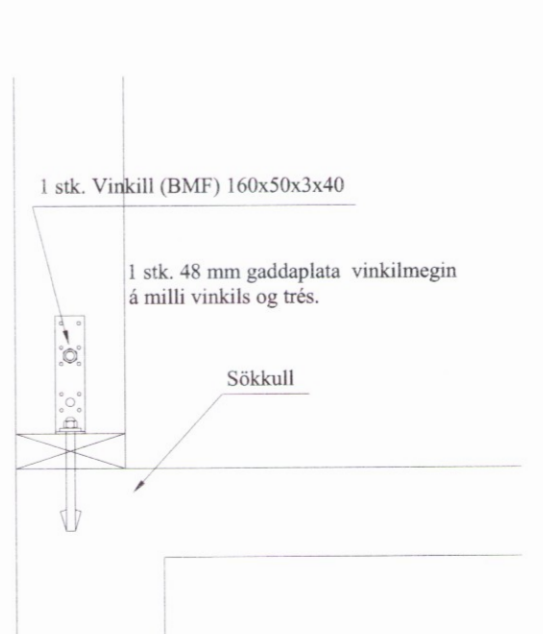
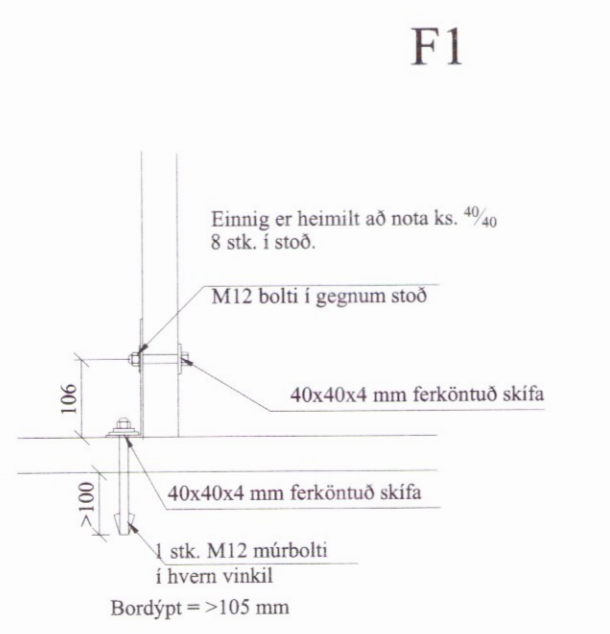

Almennt:

Öll mál skulu staðfest skv. aðaltekningum. Ef eitthvert misræmi er skulu aðalteikningar vera ráðandi, þó ber að láta hönnuði vita af misræmi.

Skýringar - trévirki veggja

Allur víður er K18 eða betri skv. DS413. Allan við utanhúss skal fúaverja. Allur saumur og festingar utanhúss skulu vera heitzinkhúðaðar eða ryðfrjár. Allar stoðir og lausholt eru  $\frac{45}{145}$  nema annað sé tekið fram. Bil á milli miðjulina stoða skal ekki vera meira en 600 mm. Utan á grind komi 9 mm gufuopinn rakapólinn krossviður (t.d. grenikrossviður). Krossviður festist með  $\frac{28}{65}$  C150 í rakapólið lím. Þétting (Aerofil-pulsa eða Illmod þéttiborði) komi undir fótstykki, einnig skal setja vindpappa undir fótstykki, sem kemur þá á milli steypu og fótstykkis.

Festingar á öllum samskeytum:

Öll horn og einingasamskeyti skal víxskrúfa saman með 6x80mm skrúfum c/c 400mm.

Festing á fótstykki

Múrboltar M12 C600 koma í gegnum fótstykki. Bordýpt = 105 mm og snertidýpt bolta við steypnan flöt => 80 mm.

F1 - F4 sjá sémyndir.

Öll mál eru í millimetrum, nema annað sé tekið fram.

Br: Breyting	Dags:	Samþ:
VERKHEITI: Miðholt 14-22 801 Bláskógabyggð	TEIKNUNUMÉR: 204	
VERKHLUTI: Burðarvirki Ásýnd grindur og deili	ÚTGÁFA: A1	
Hönnuður: Björgvin Viglúndsson kt. 040546-2009	Samþykkt: <i>Bent Larsen</i>	BLADSTÆRD: A-2
Yfirfarið af hönnunarstjóra: Bent Larsen kt. 141177-3469	Samþykkt: <i>Bent Larsen</i>	DAGS: 17.03.17
Bent Larsen Fróðason Byggingafræðingur B.Sc. Sími 844-7699 bsverk@gmail.com	VERKNR: 17-08	MKV: 1:50 1:10