

E SNID
B4 M. 1: 20

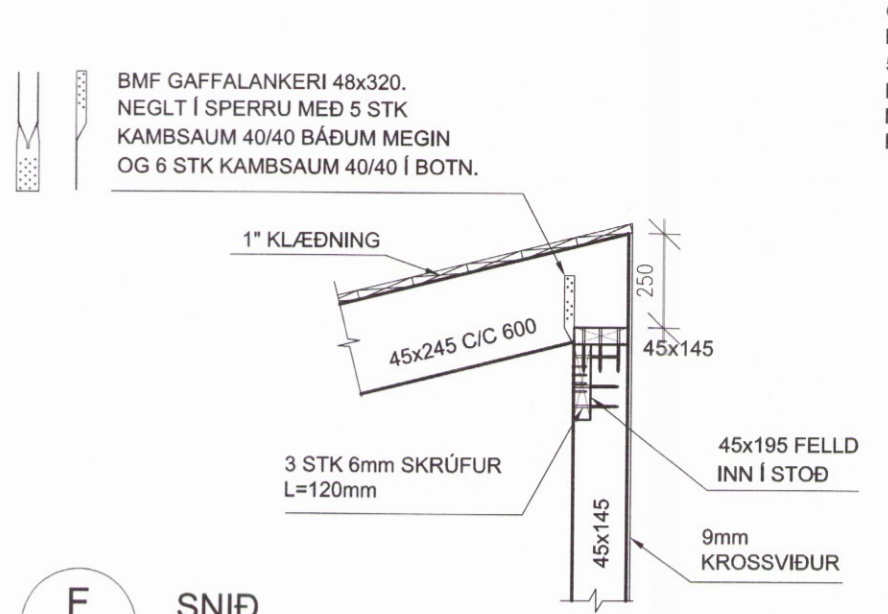

F SNID
B4 M. 1: 20

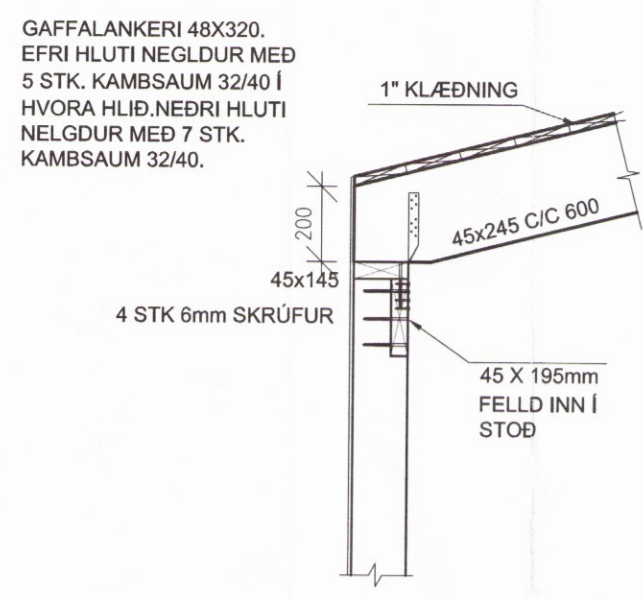

G SNID
B4 M. 1: 20

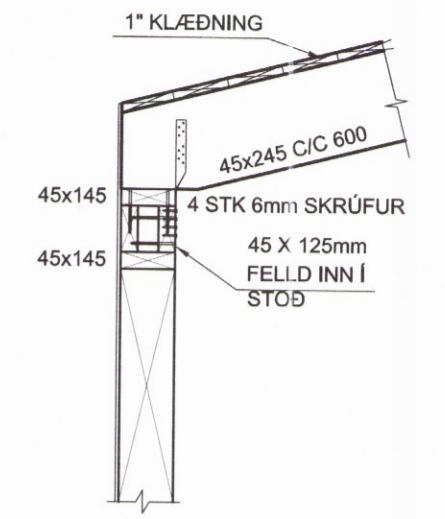

H SNID
B4 M. 1: 20

GAFFALANKERI 48X320.
EFRI HLUTI NEGLDUR MED
5 STK. KAMBSAUM 32/40 Í
HVORA HLID.NEÐRI HLUTI
NELGDUR MED 7 STK.
KAMBSAUM 32/40.

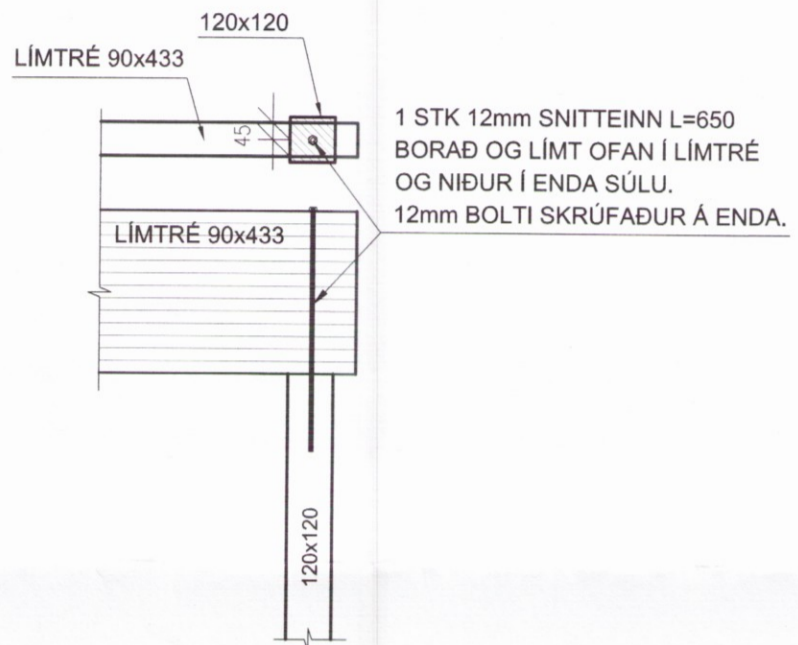

I SNID
B4 M. 1: 20

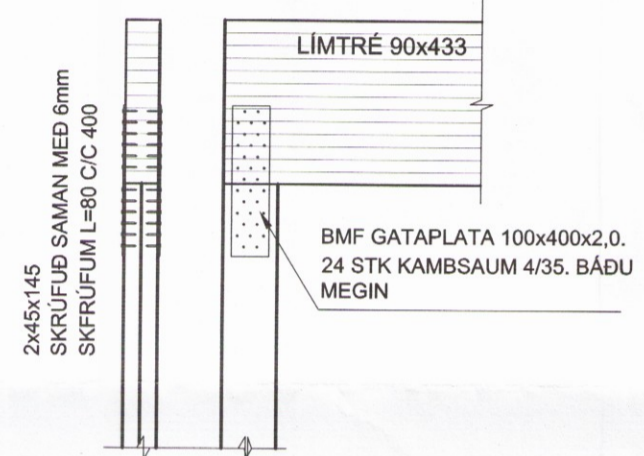

J SNID
B4 M. 1: 20

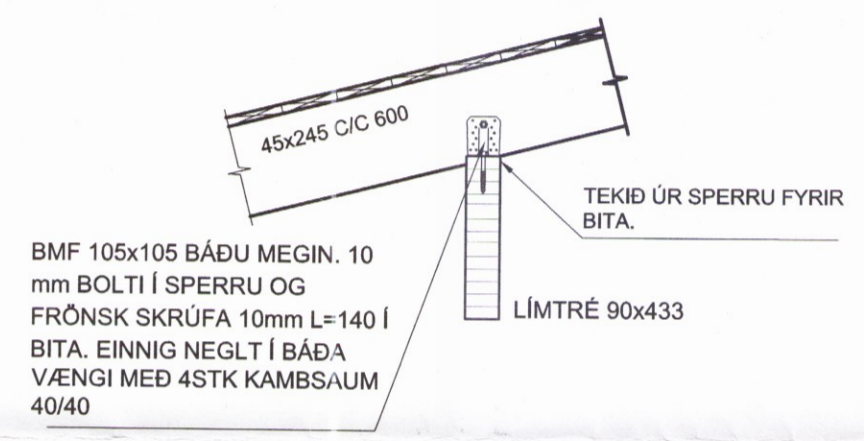

K SNID
B4 M. 1: 20



SKÝRINGAR

Kótar eru í m.y.s
Málsetningar eru í mm

- KOTI Merkir hæðarkóti í sniði
 - MÉR Merkir hæðarkóti í plani
 - 150 Merkir þykkt plötu
- Sjá einnig skýringarblað

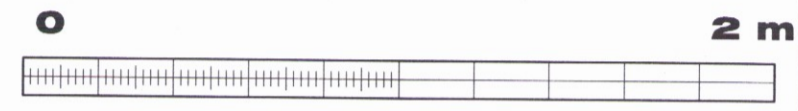

M. 1:20

C
B
A

BREYTINGAR

Samþykkt Samþykki aðalhönnuðar

VEB VEB Verkfæðistofa
Dalvegur 18, 201 Kópavogur
Sími 564 3322, GSM 898 1198
Netfang veb@veb.is
Ráðgefandi verkfræðipjónusta

VERKHEITI
KERBYGGÐ 9, GRÍMSNESI

Teikning nr
B5

HEITI TEIKNINGAR
**ÞAKVIRKI
SNID**

Dagsetning	Hannað	Yfirfarið	Kvarði	Tölvuheiti
MAÍ 2017	ESB	ERLENDUR BIRGISSON 261156-2539	1:20	2.16.03