

GL-1 b
Fjöldi: 1 stk

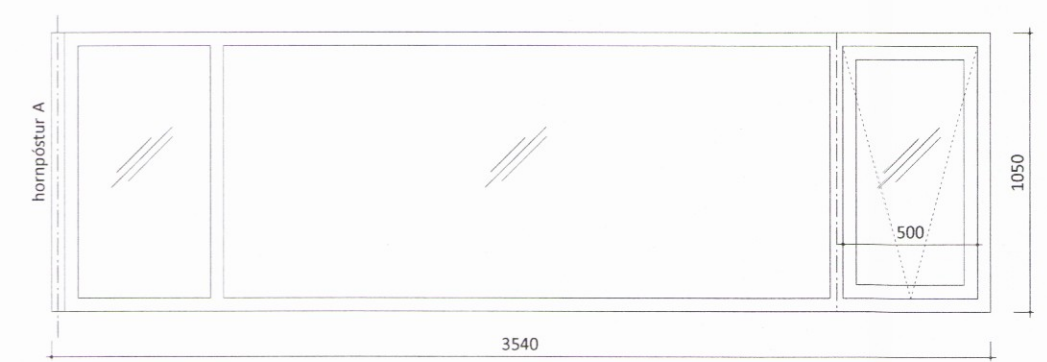

GL-1 a
Fjöldi: 1 stk

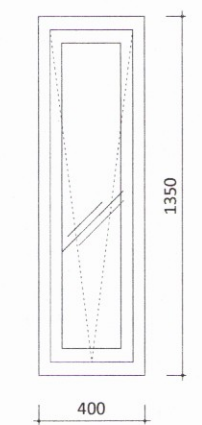

GL-2
Fjöldi: 2 stk

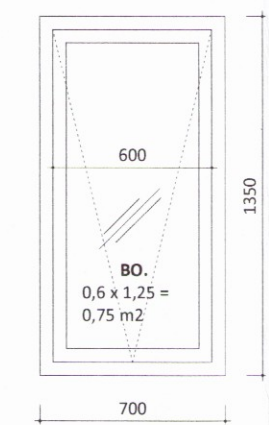

GL-3
Fjöldi: 2 stk

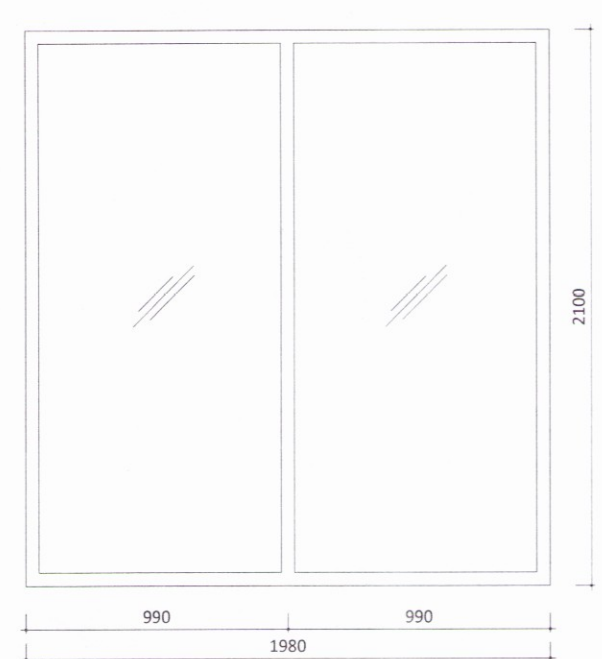

GL-4
Fjöldi: 1 stk

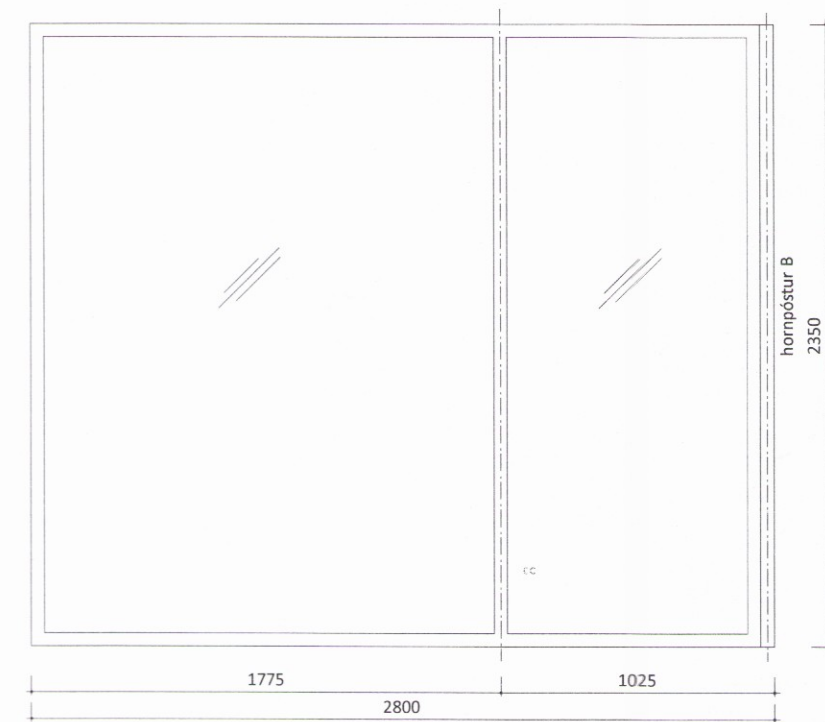

GL-5 a
Fjöldi: 1 stk

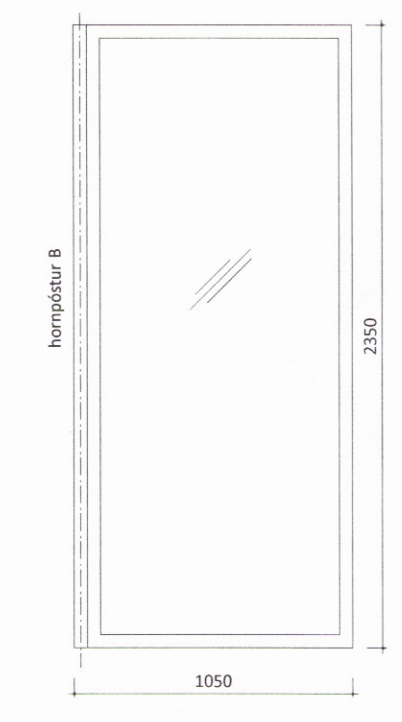

GL-5 b
Fjöldi: 1 stk

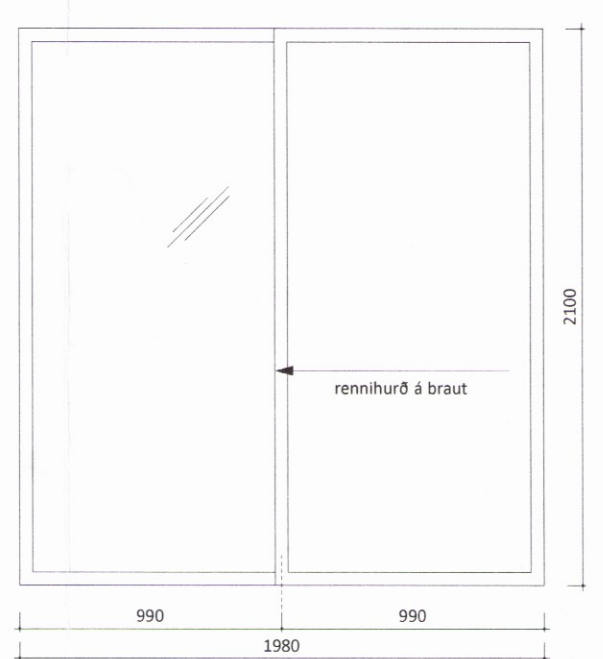

GL-6
Fjöldi: 1 stk



GL-7
Fjöldi: 1 stk

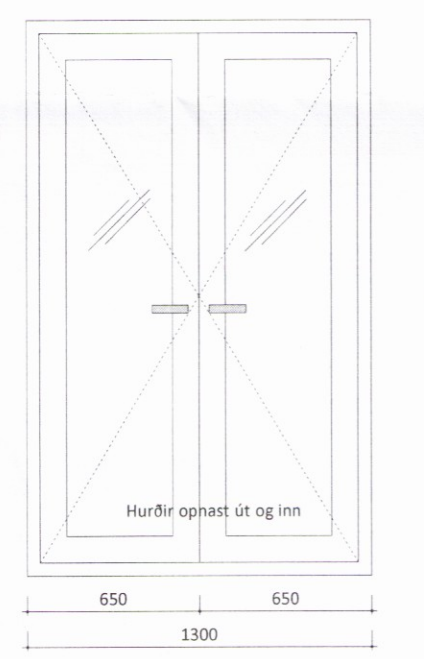

GL-8
Fjöldi: 1 stk

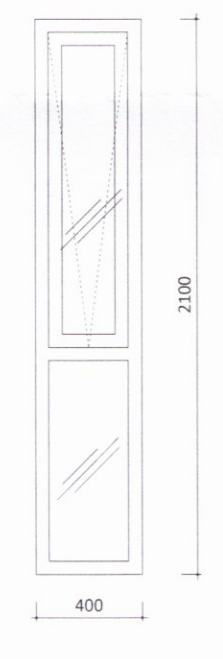

GL-9
Fjöldi: 3 stk

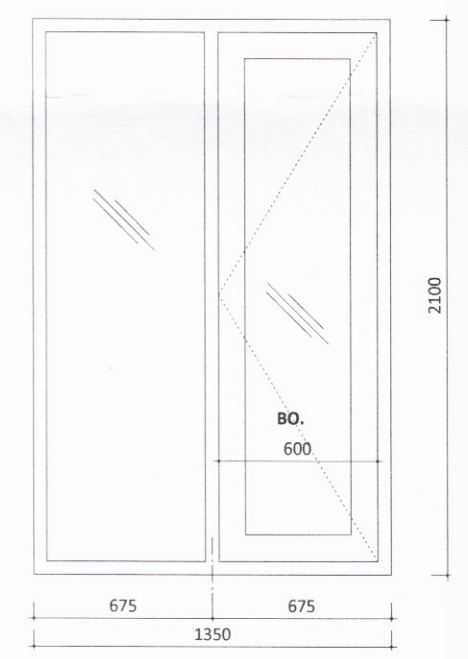

GL-10
Fjöldi: 1 stk

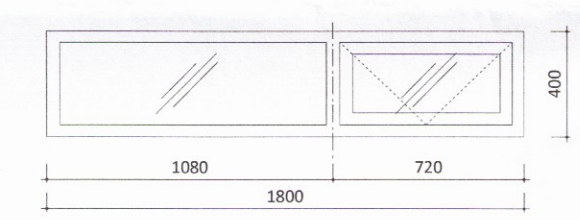

GL-11
Fjöldi: 2 stk

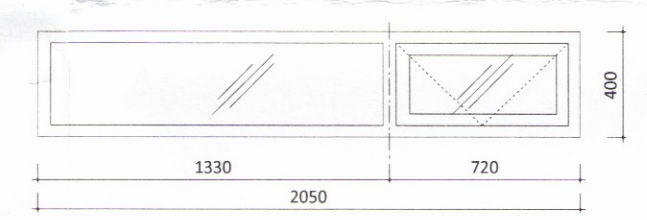

GL-14
Fjöldi: 2 stk

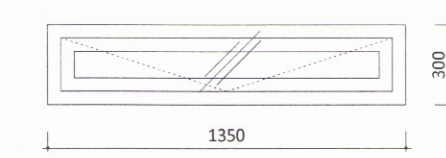

GL-12
Fjöldi: 1 stk

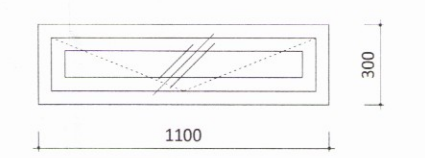

GL-13
Fjöldi: 1 stk

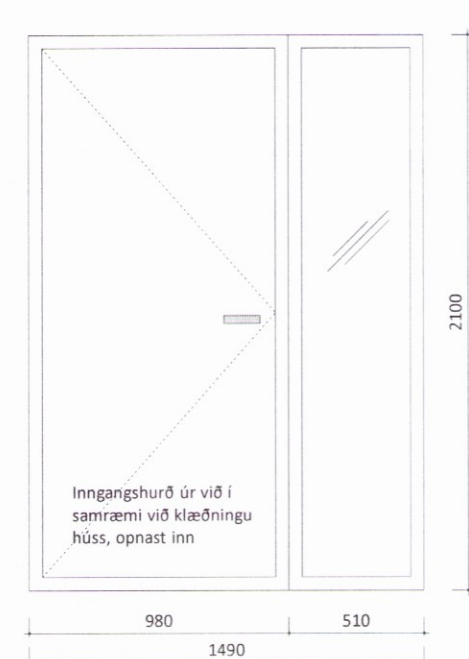

UH-1
Fjöldi: 1 stk

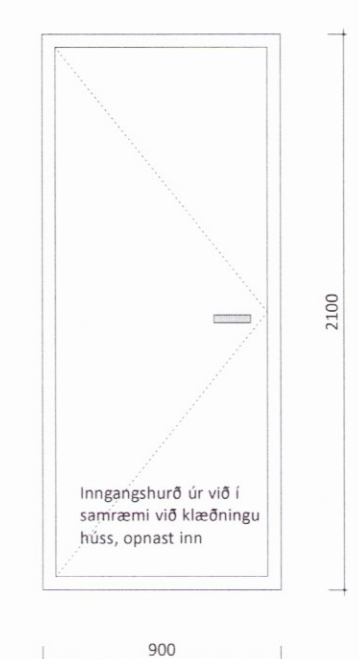

UH-2
Fjöldi: 1 stk

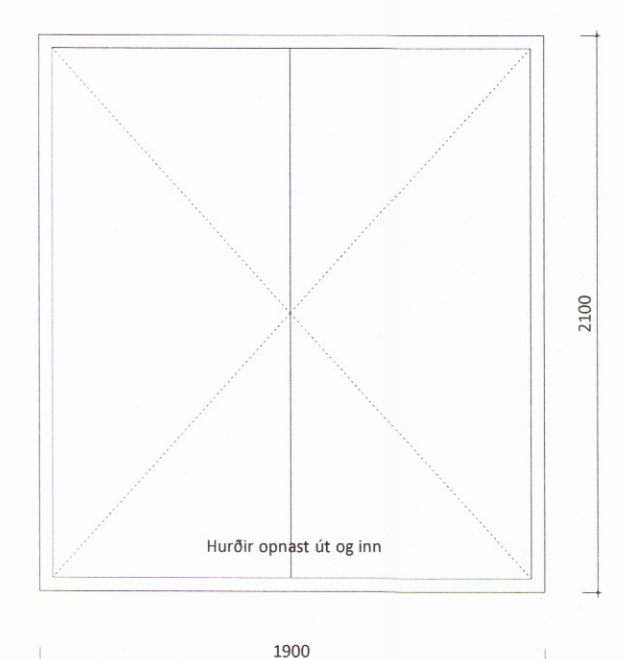

UH-3
Fjöldi: 1 stk

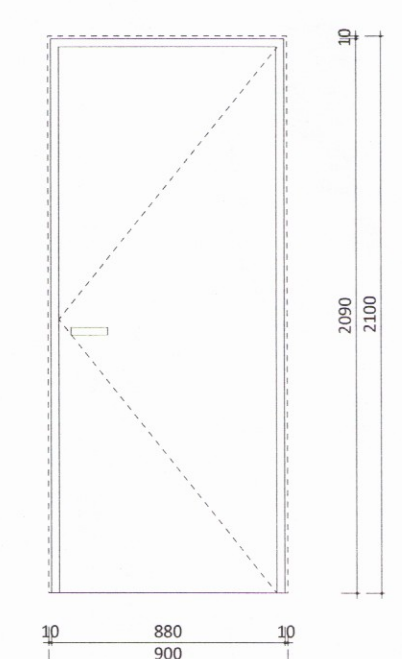

IH 1
3 stk.
Vinstri opnun
Opnast inn í rýmið
sjá grunnmynd

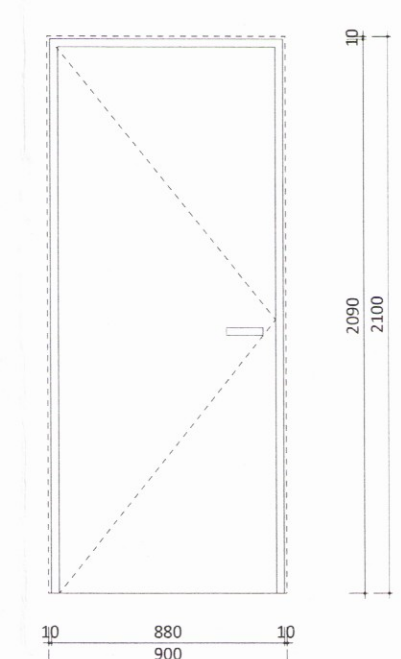

IH 2
3 stk.
Hægri opnun
Opnast inn í rýmið
sjá grunnmynd

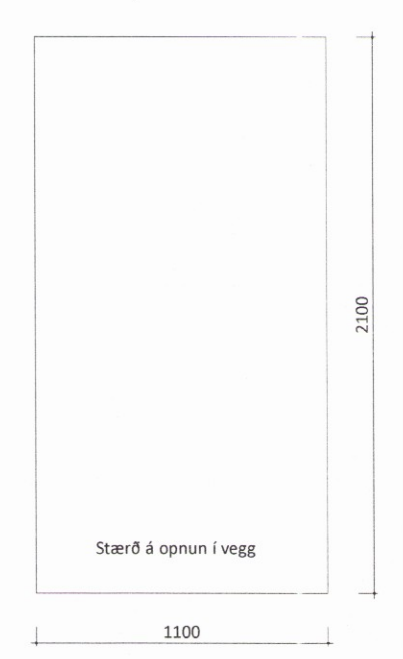

RH 1
2 stk.
Rennihurð á braut
sjá grunnmynd

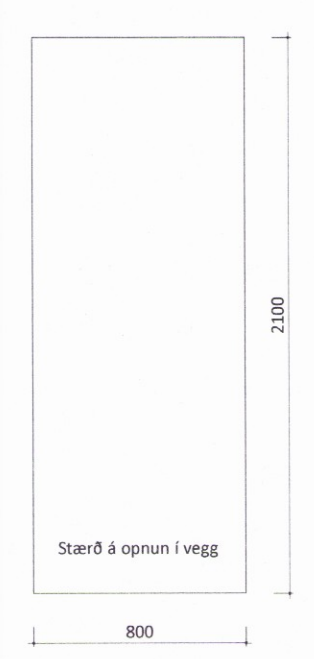

RH 2
1 stk.
Rennihurð á braut
sjá grunnmynd

ATH.:
 - Öll mál athugist og mælist á staðnum áður en smíði hefst.
 - Ósamræmi í teikningum tilkynnist eftirlitsmanni verkkaupa.
 - Öll mál eru í millimetrum.

ATH.:
 - Öll mál á umfangi glugga og hurða eru utanmál með fúgu meðaldrí til samræmis við málsetningar í grunnmynd.

3542

A.20.06
Sumarhús og gesthús, Þórstígur 27, Ágarósland, 801 Grímanes- og Gröfningshr.
 Fastanúmer láðar: 234-3785
 Landnúmer: 37826
 Staðgreinar: 8719-1-13000270
 verknúmer: 127
 teikning: Glugga- og hurðayfirlit
 dags.: 20. janúar 2017
 m.k.v.: 1:25
 teiknað: HHH
 breyting:
 dags.:
 skýring:

TEIKNIVANGUR
 Klappavangur 8 - 104 Reykjavík
 Sími: 591 1111 | fexi: 591 1477
 net: teiknivangur@teiknivangur.is | www.teiknivangur.is
 Hella Haraldsdóttir Hamar, kt. 11066-5539