

SÉRMYND 1, 1:10

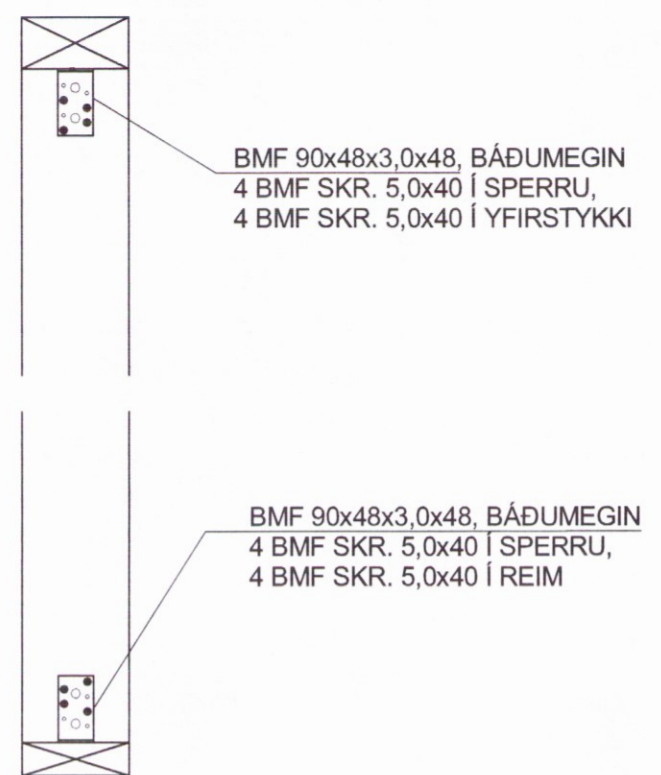

SÉRMYND 2, 1:10

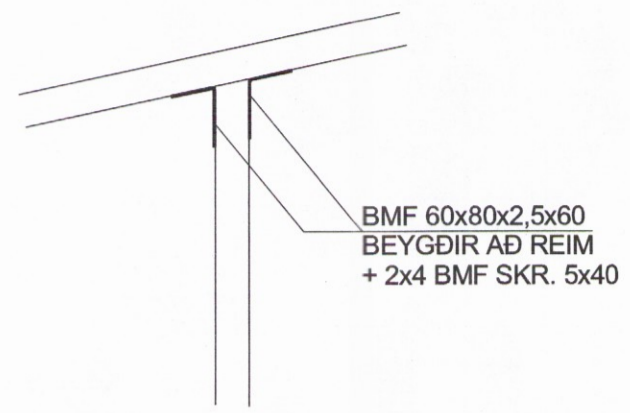

SÉRMYND 3, 1:10

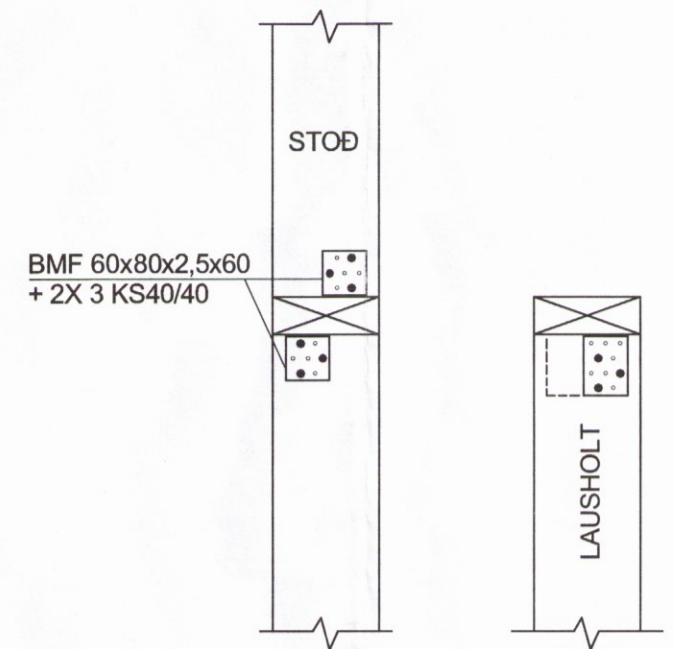

SÉRMYND 4, 1:10

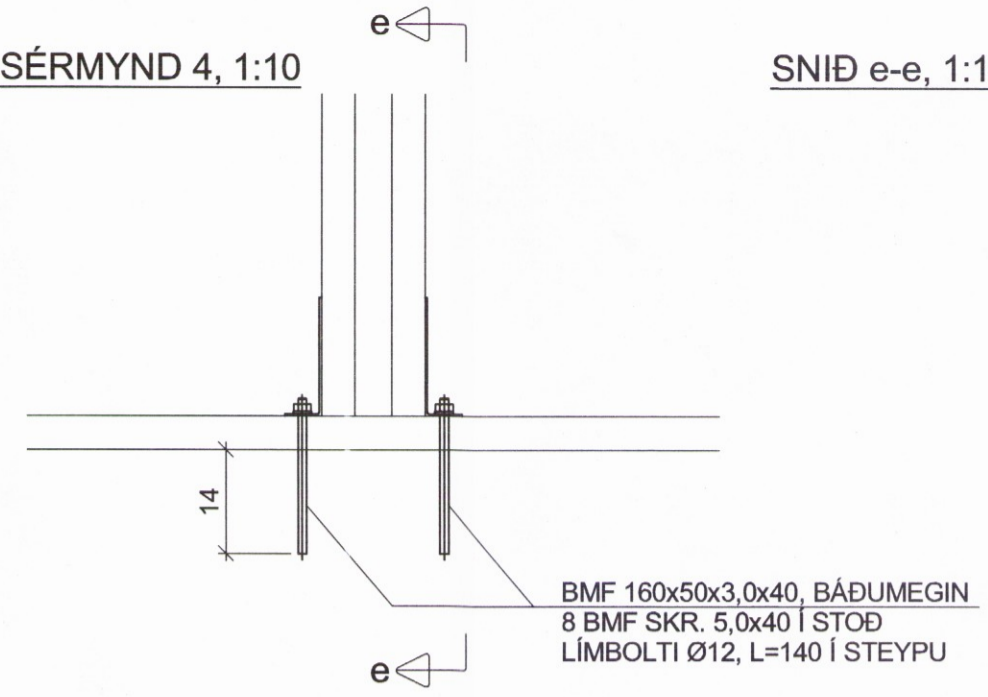

SNIÐ e-e, 1:10

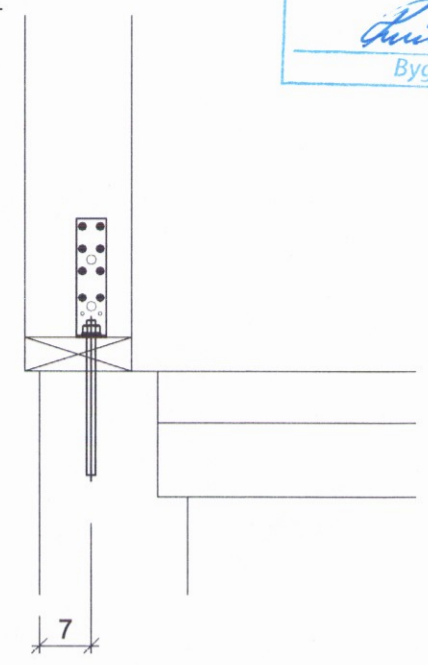

SÉRMYND 6, 1:10

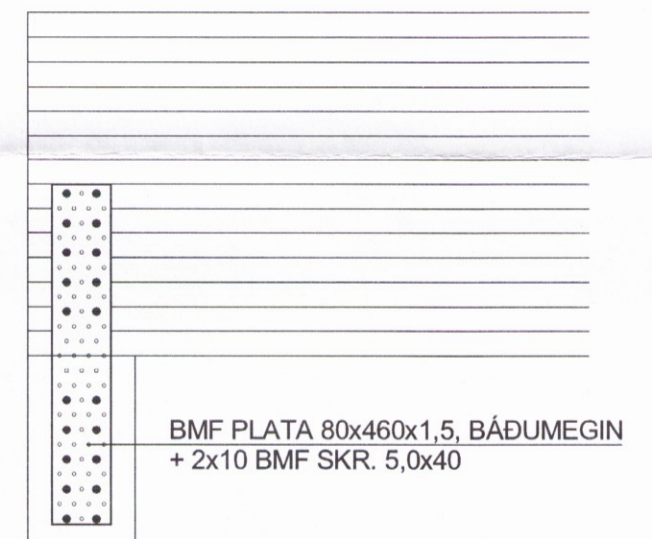

SÉRMYND 5, 1:10

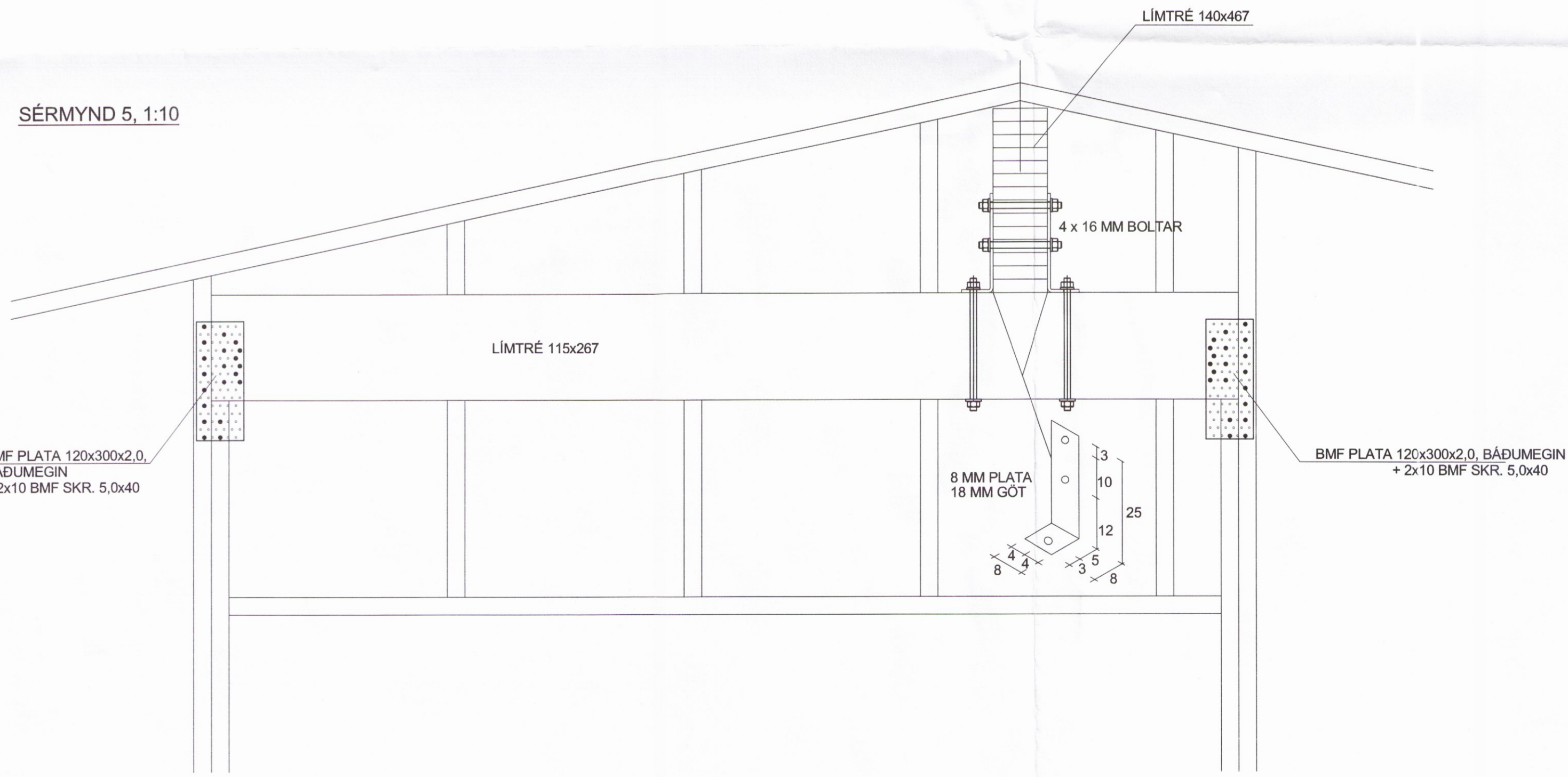

SÉRMYND 7, 1:10

Hönnuður: Guðmundur Óskar Unnarsson  
 Kt. 110683-3409

Haukur Margeirsson byggingarverkfræðingur  
 Verkfræðistofa - Álfrólsvogur 32 - 200 Kópavogur  
 Sími 554 4543 - GSM 699 8260  
 kt. 070249 3919 - netfang: haukurm@simnet.is

Haukur Margeirsson

VERKHEITI	ÁSABYGGÐ 43 3697 HRUNAMANNAHREPPI		
HEITI TEIKN.	ÚTVEGGJAGRINDUR SÉRMYNDIR		
HANNAÐ	HM	DAGS.	30. APRÍL, 2017
TEIKNAD	HM	VERKNR.	170330
		KVARÐI	30. APRÍL, 2017
		TEIKN. NR.	204
			1:10