

Umhverfis- og tæknisvið Uppsveita
Yfirfarið
 21. agu. 2018
 D-5
 Byggingarfulltrúi

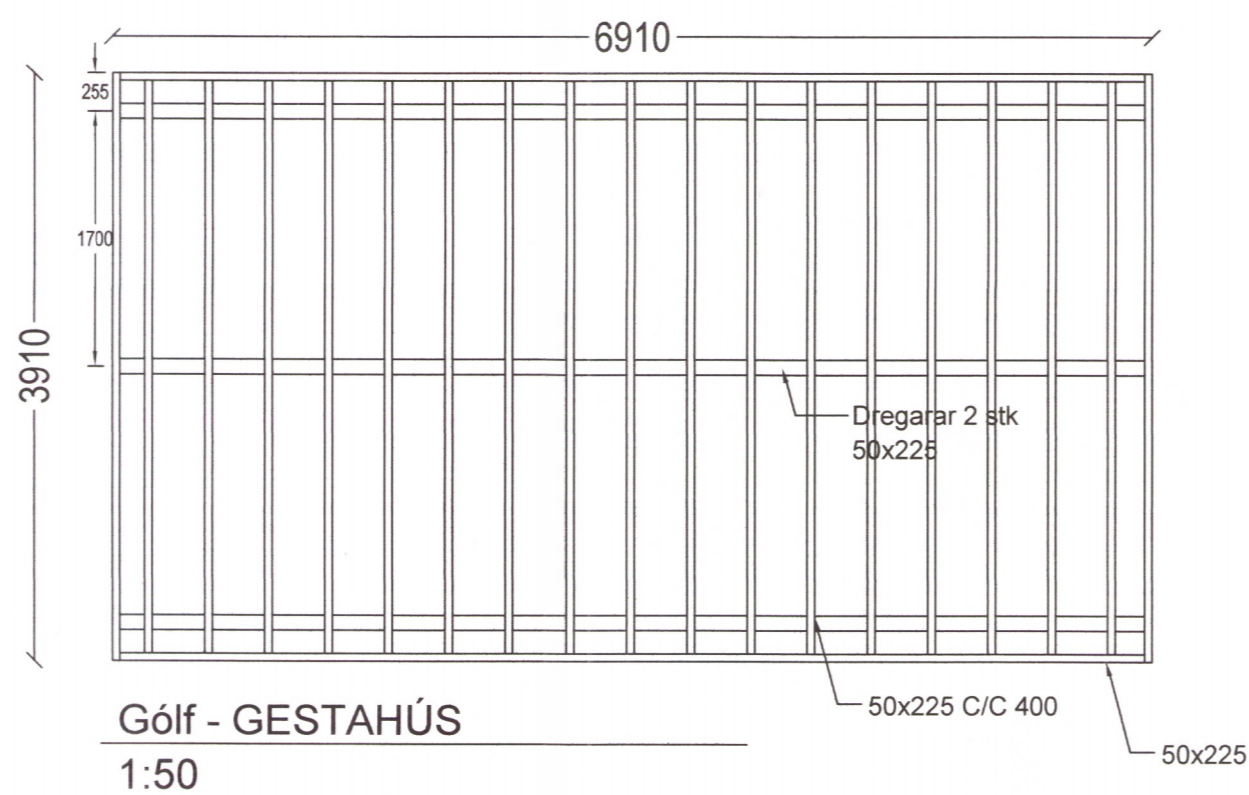

Gólf - GESTAHÚS
 1:50

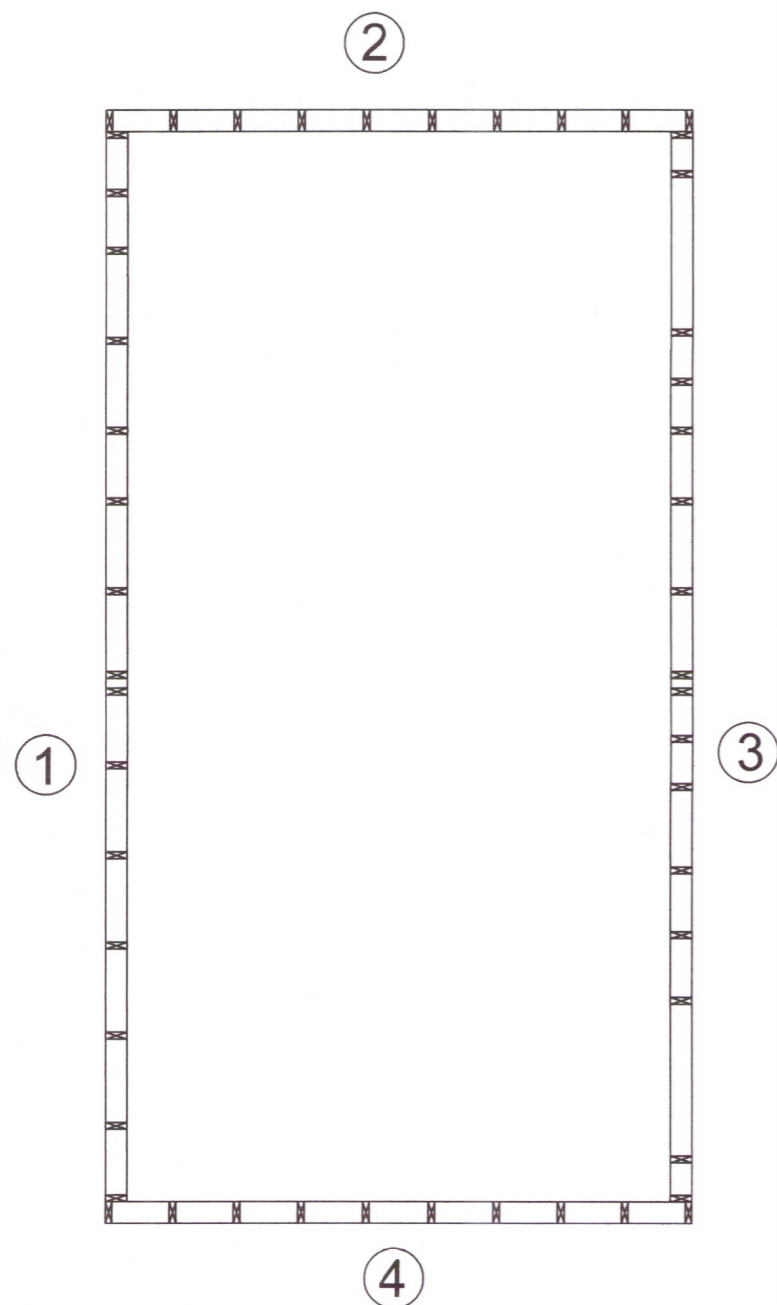
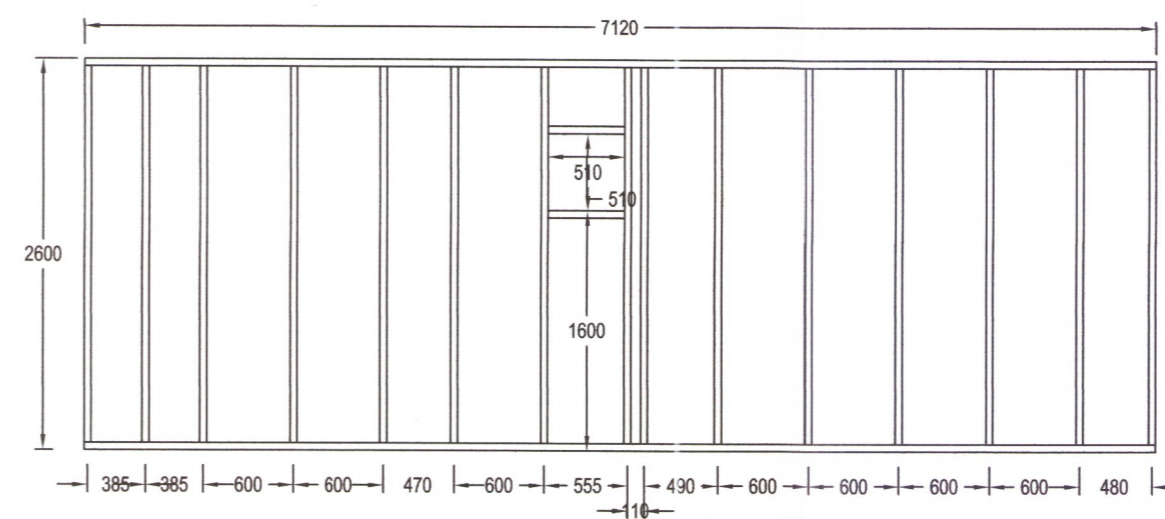

①

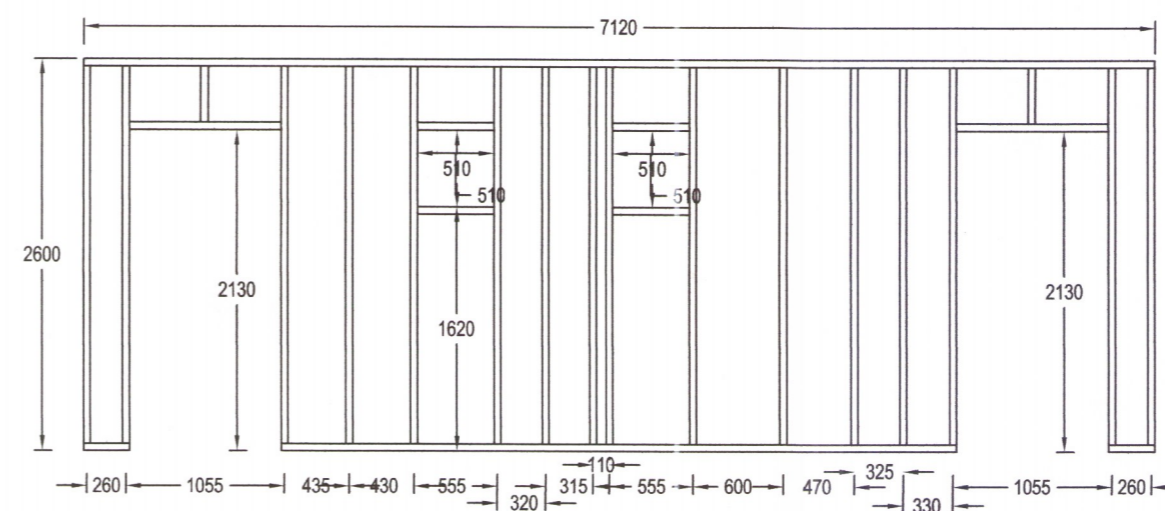

③

Númering grinda
 1:50

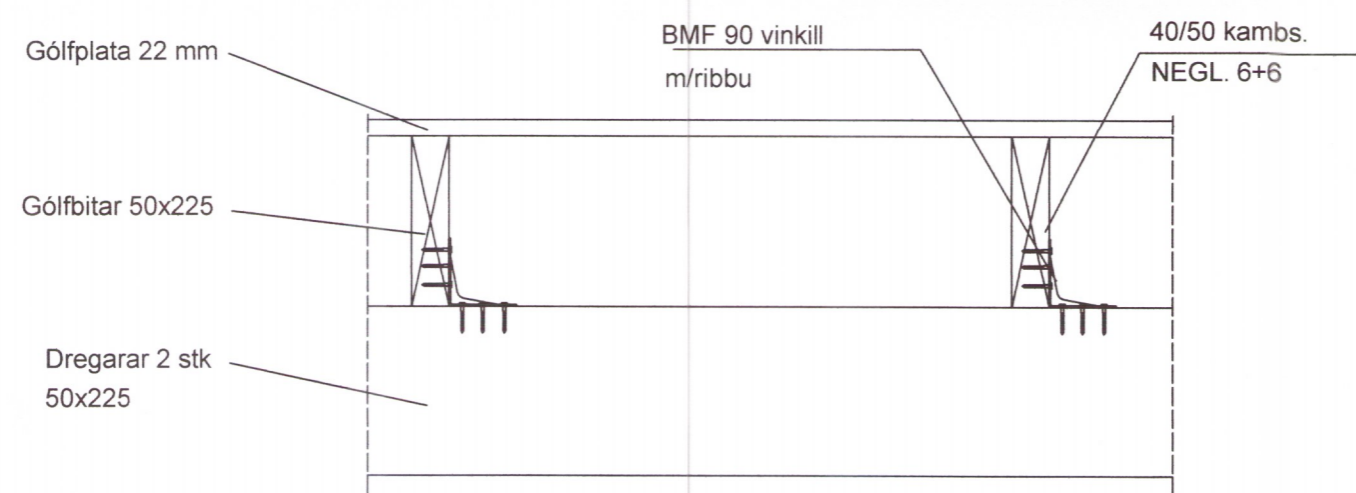

Festing dregarar/gólfbitar
 1:10

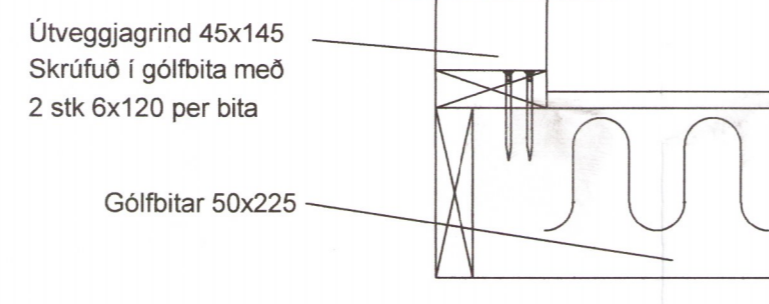

Vegggrindur/gólfbitar
 1:10

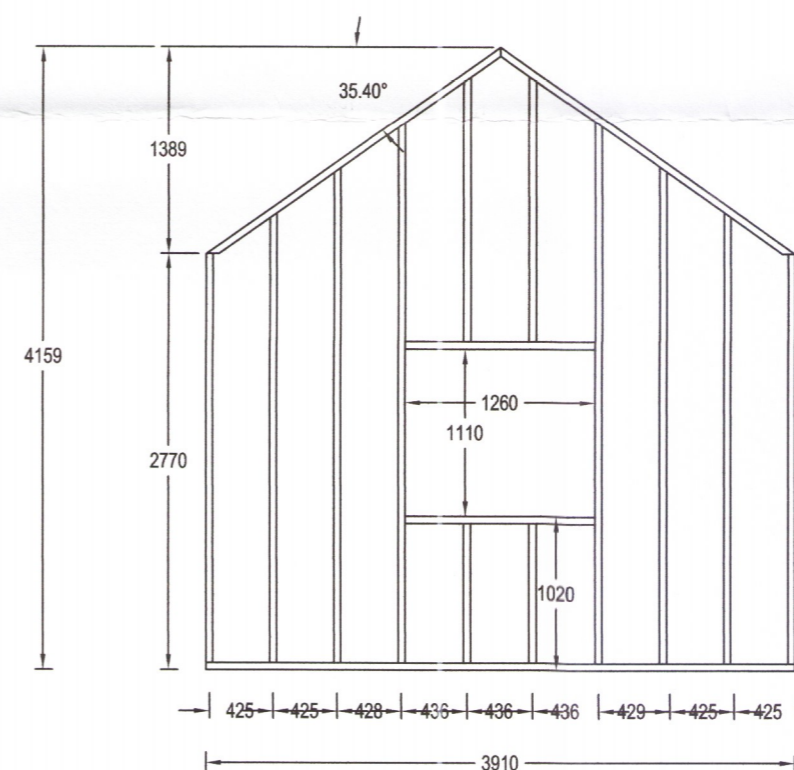

② ④

GRINDAREFNI ÚR 45x145
 VINDSTÍFING ERU 9 MM
 KROSSVIÐUR SKRÚFAÐUR
 Í GRIND MEÐ 5x60 C/C 200

SNIÐ OG FRÁGANGUR SJÁ TEIKNINGU B103
 SKÝRINGAR SJÁ TEIKNINGU B100

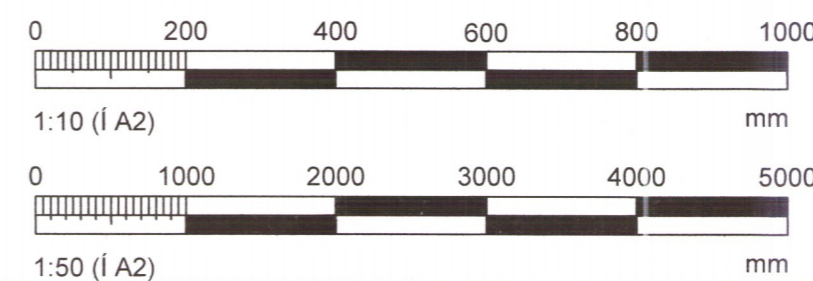

HRAUNTRÖÐ 24, GR.- OG GRAFNINGSHR. FRÍSTUNDAHÚS - GESTAHÚS BURÐARVIRKI - ÚTVEGGIR OG GÓLF 1 AF 2		5712-18		Tölvunafn.		
		Mælikvarði	Hannað	SVa	júlí 2018	
		1:10	Teiknað	SVa	júlí 2018	
		1:50	Samp.	<i>S. Vald</i>		
		Plottað	13.07.2018			
Beimur ehf. Verkfræðipjónusta Sveins Vald. <small>Suðurgarði 1, 230 Reykjanesbæ, kt. 510817-0950 Sími: 895 2710 Netf.: beimur@simnet.is</small>		Sveinn Valdimarsson MVFI kt. 271068-3879				
		Teikningarnúmer B111 20-14				
		Breyting: <table border="1" style="display: inline-table; width: 100px; height: 20px;"><tr><td> </td><td> </td><td> </td><td> </td></tr></table>				
		Ath.				