

Umhverfis- og tæknisvið Uppsveita
 Yfirfarið
 25. sep. 2018
 David S.S.
 Byggingarfulltrúi

NR. DAGS. BREYTING

SKÝRINGAR

SKÝRINGAR SJÁ TEIKN B001
 ÖLL MÁL Á TEIKNINGU Í MILLIMETURUM
 EKKI SKAL MELA UPP AF TEIKNINGU
 EFNISPYKKT 4 mm NEMA ANNAD KOMI
 FRAM Á TEIKNINGUM

21/9/18
 SÆMUNDUR EIRIKSSON 261249-2949

HLÖDUVELLIR
 landnúmer 226466
 Laugardalsafréttur
 BLÁSKÓGABYGGD



KLÖPP ARKITEKTAR-VERKFRÉDINGAR EHF
 NETHYL 2E, PÓSTHÓLF 10050, 130 REYKJAVÍK
 SÍMI 577 2277, 699 7747 - klopp@simnet.is

HEITI TEIKN. HESTHÓUS *5984-18*
 STÁLGRIND FESTINGAR
 MELIKVARDI 1:10 DAGS. SEPT 2018
 TEIKNING B 007 VERK V 18-502
 BREYTING YFIRFARID S.E.

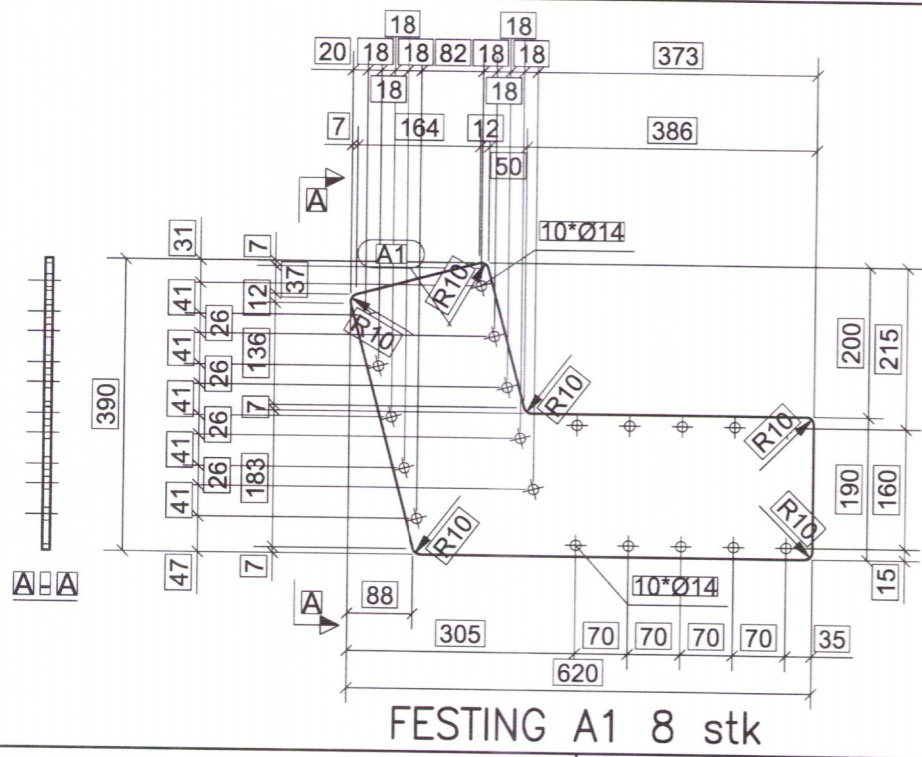

FESTING A1 8 stk

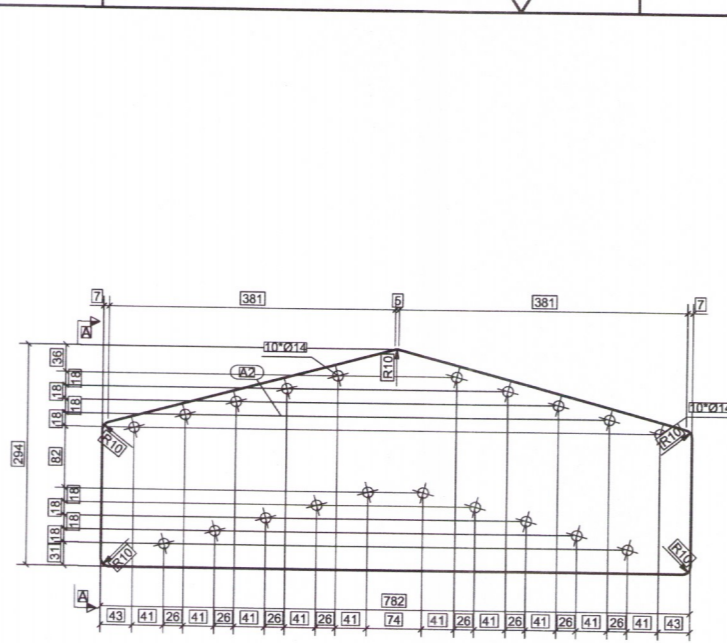

FESTING A2 4 stk

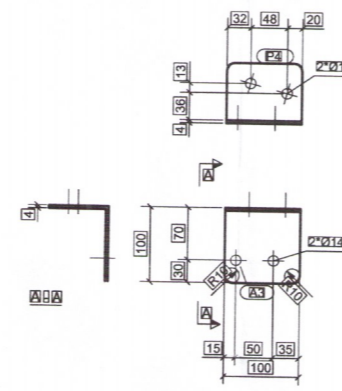

FESTING A3 6 stk

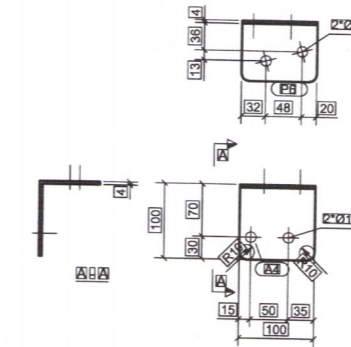

FESTING A4 6 stk

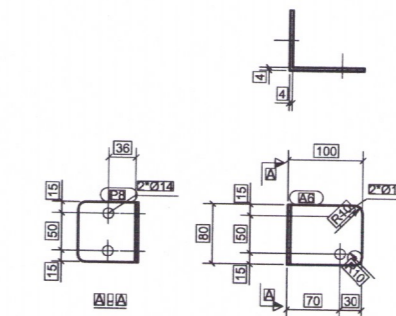

FESTING A6 116 stk

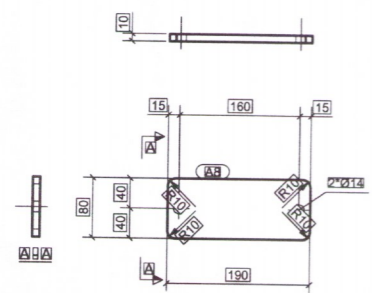

FESTING A8 44 stk

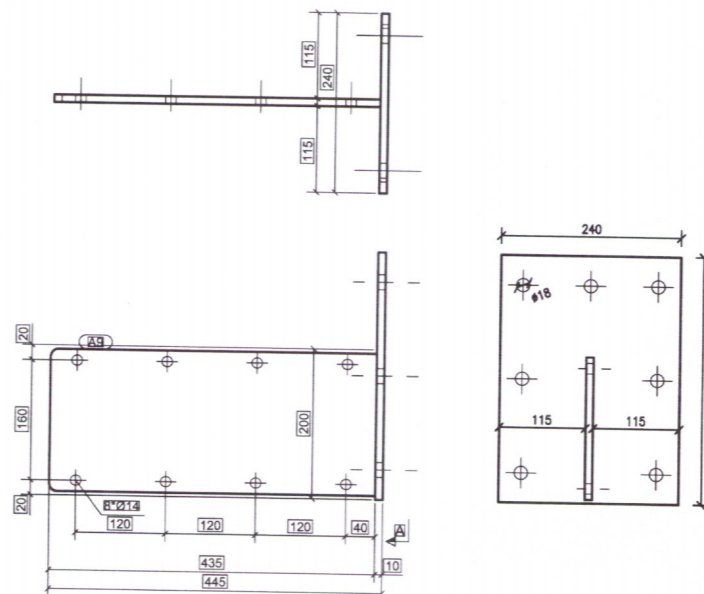

FESTING A9 4 stk

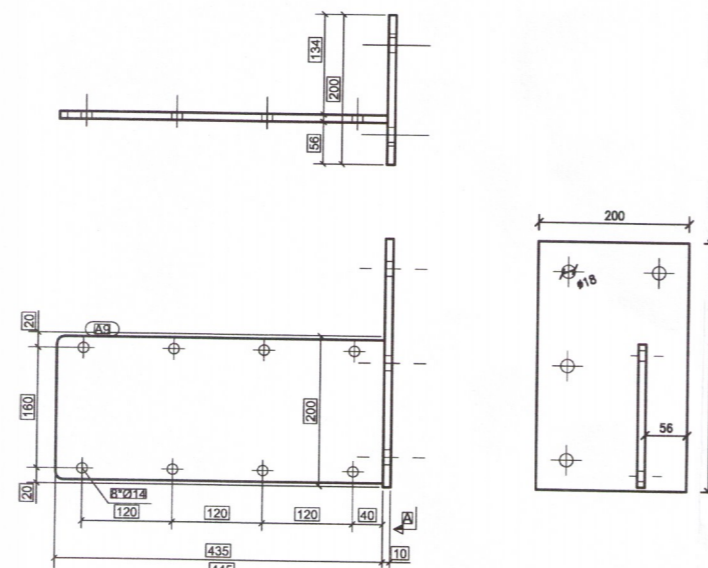

FESTING A9-1 2 stk

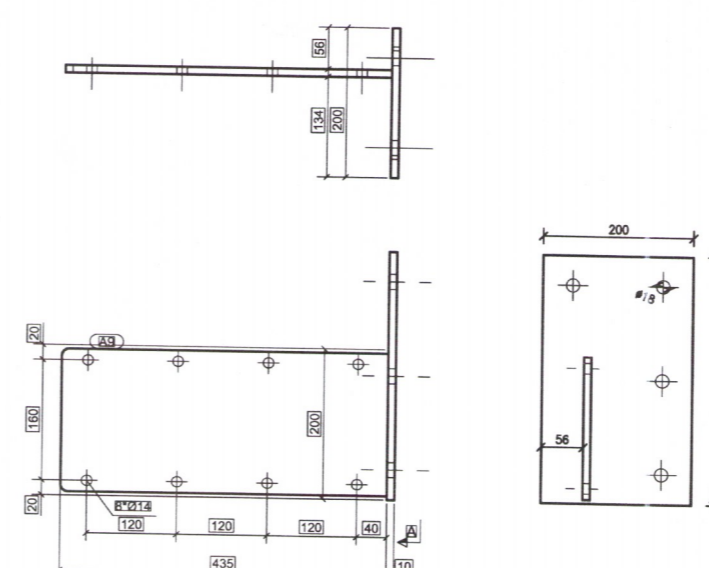

FESTING A9-2 2 stk

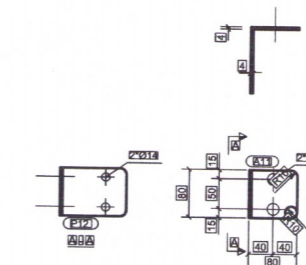

FESTING A11 4 stk

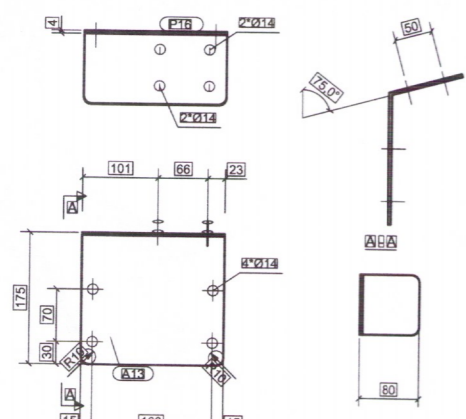

FESTING A13 1 stk

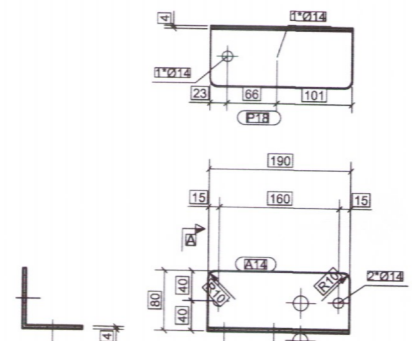

FESTING A14 8 stk

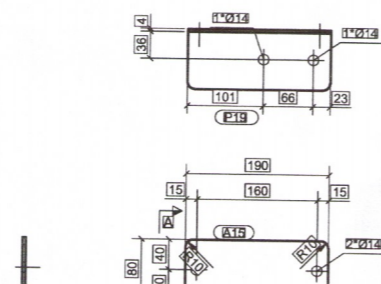

FESTING A15 8 stk

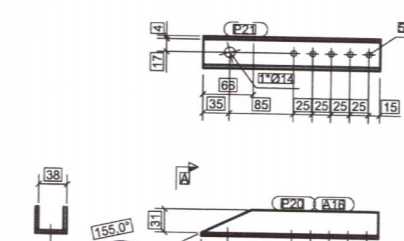

FESTING A16 16 stk

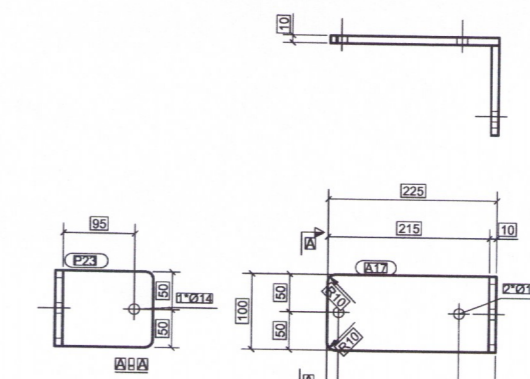

FESTING A17 16 stk

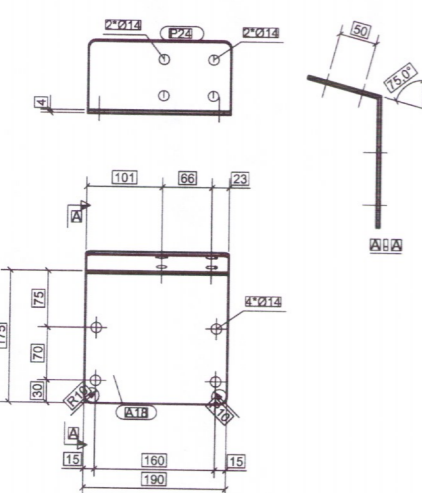

FESTING A18 1 stk

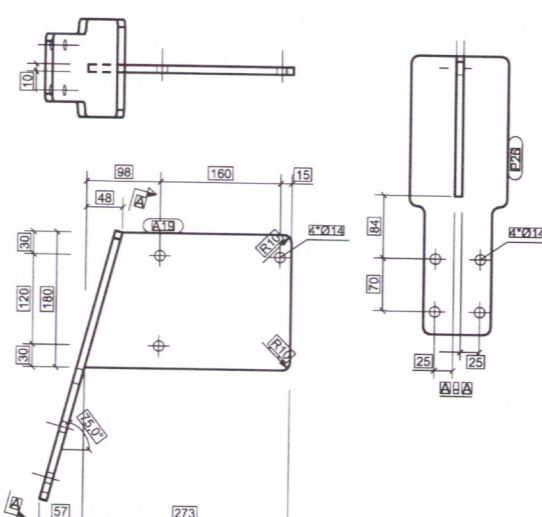

FESTING A19 4 stk