

Umhverfis- og tæknisvið Uppsveita  
**Samþykkt**  
 16. júní 2020  
*David Sigurdsson*  
 Byggingarfulltrúi

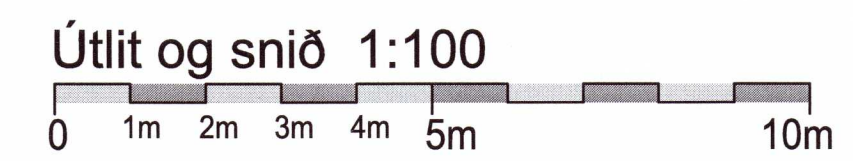

dagsletning x      breyting x      teiknað GBS

20201589

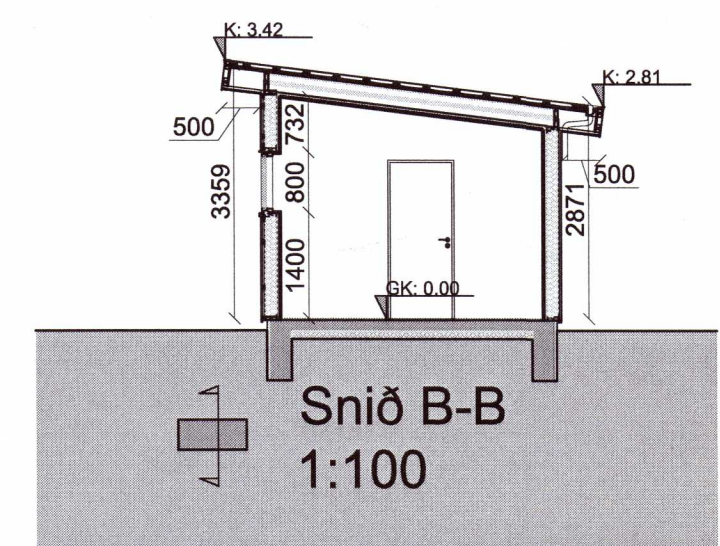
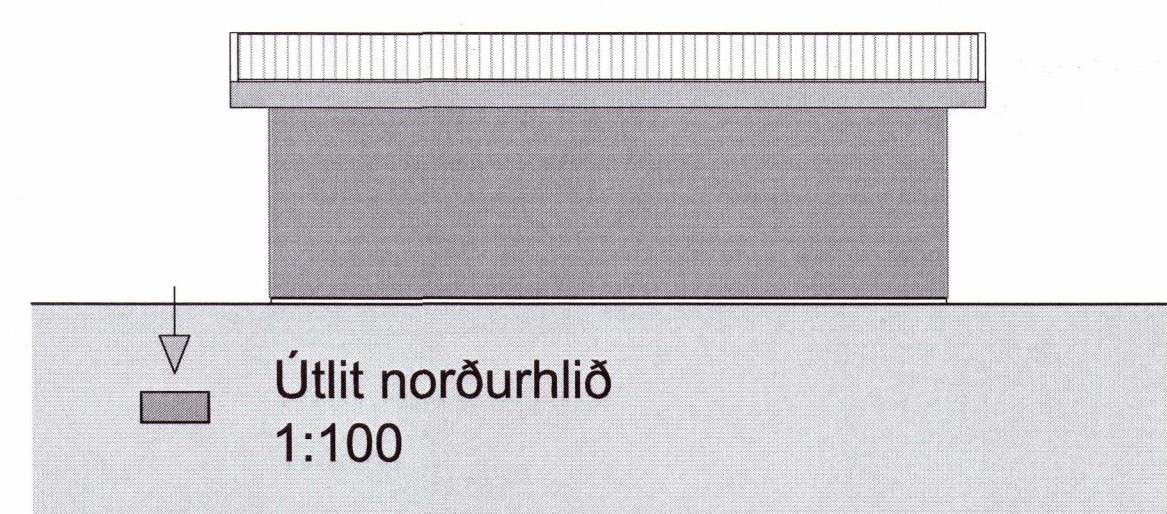
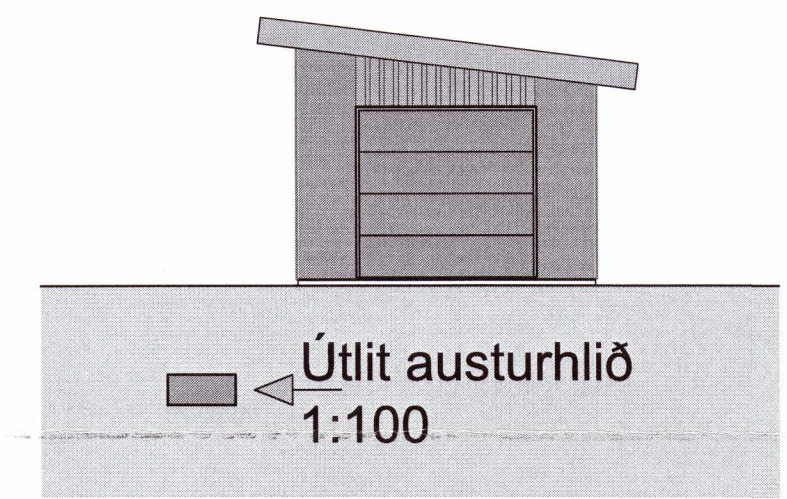
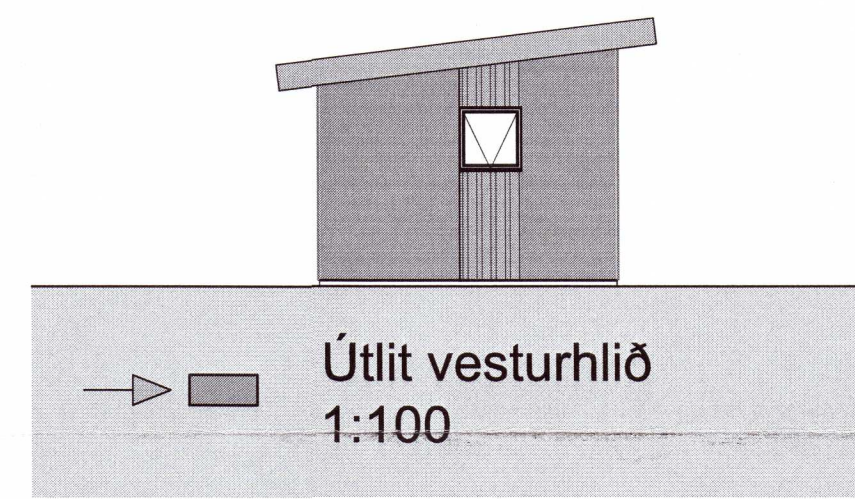
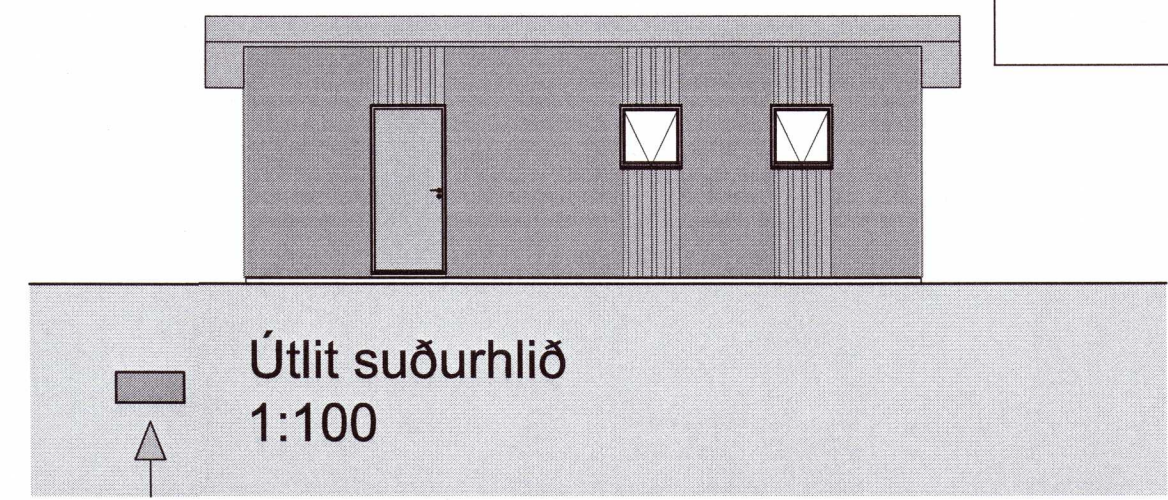
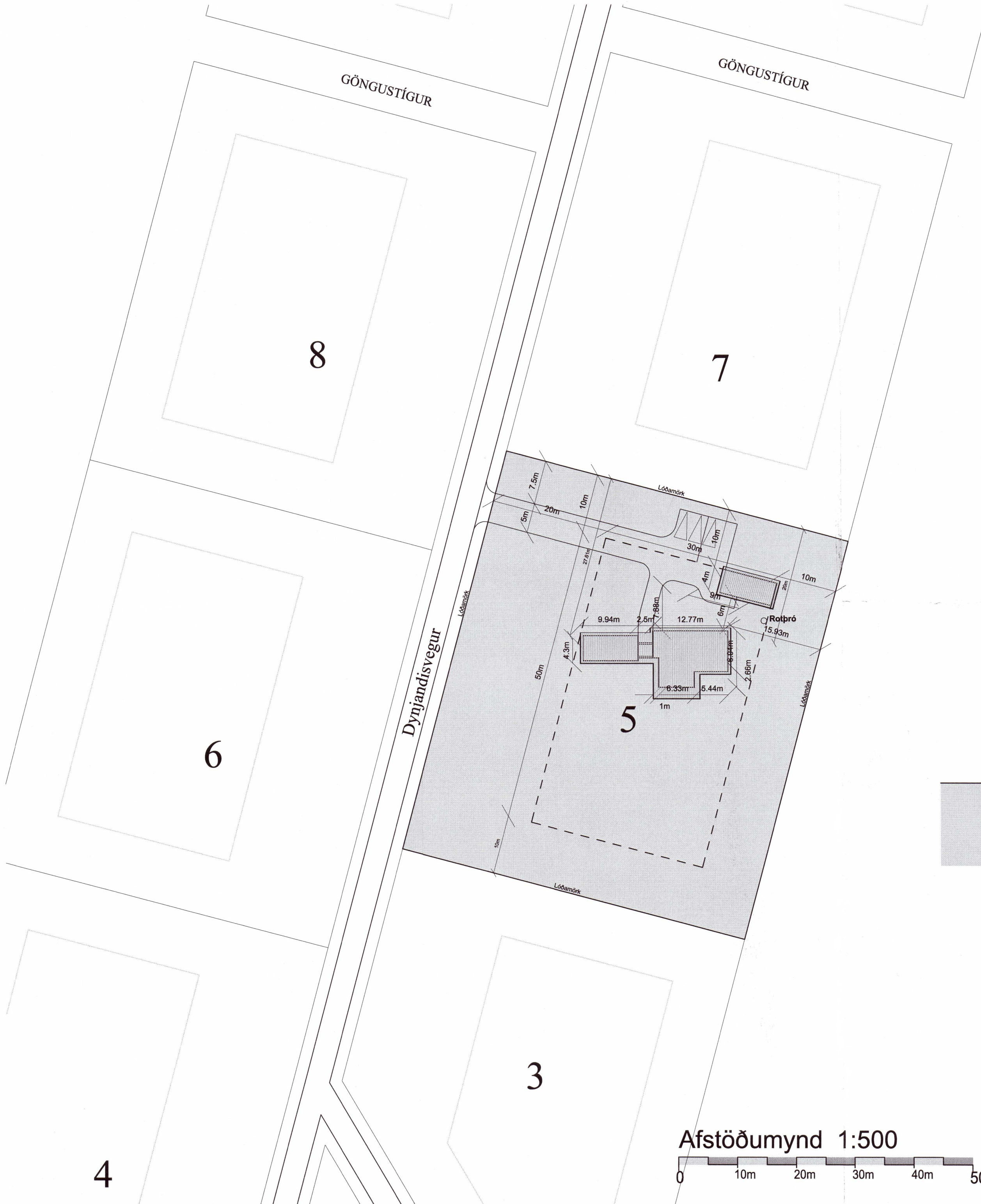
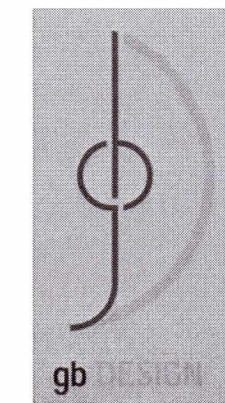
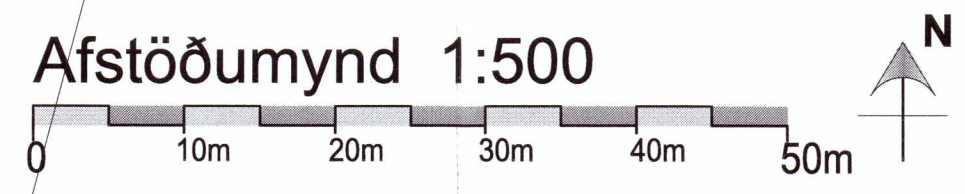

Verk: Dyjndisvegur 5  
 Teikning: Afstöðumynd sniði og útlit vinnuskúrs  
 Gunnar Bergmann Stefánsson arkitekt kt: 250864-4859  
 GSM: *[Signature]* 864-2282  
 E-mail: gunnar.bergmann@gmail.com  
 Mælið ekki upp af teikningum. Hafið samband við höfund komi upp misærmi í málsetningum. Öll afrit og afritun teikningar, að hluta eða í heild, er háð skriflegu leyfi höfundar © Gunnar Bergmann Stefánsson

dagsletning 26.05.2020  
 málkvarði - blaðstærð 1:500/1:100 - A2  
 teiknað GBS  
 verk 19910  
 teikning 01.03