

Umhverfis- og tæknisvið Uppsveita
Sampykkt
 20. maí 2020
Dagur Sigurðsson
 Byggingarfulltrúi

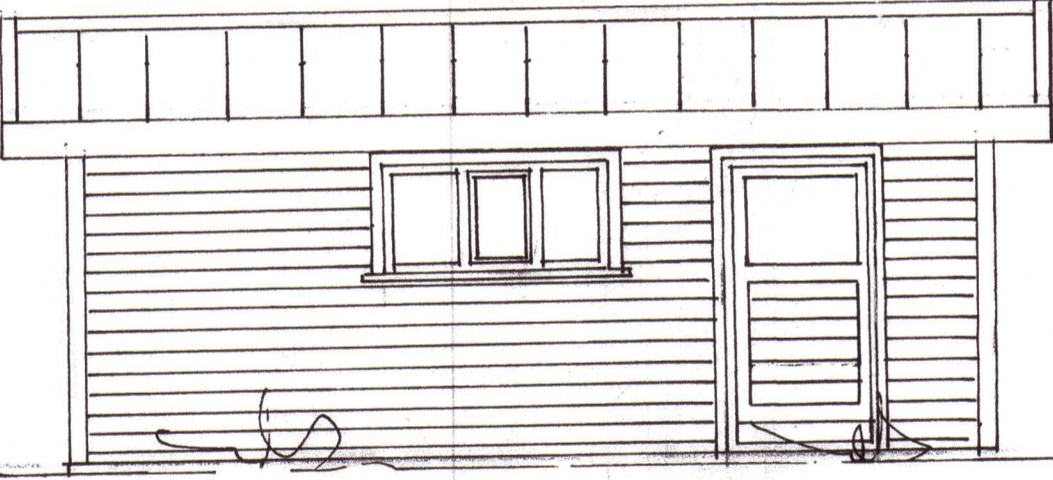

- ⊖ BD BJÓRGUNAROP ⊖ GN GÓLFNIÐURFALL
- ⊖ RS REYKSKYNJARI
- ⊖ ST SLÓKKVITÆKI

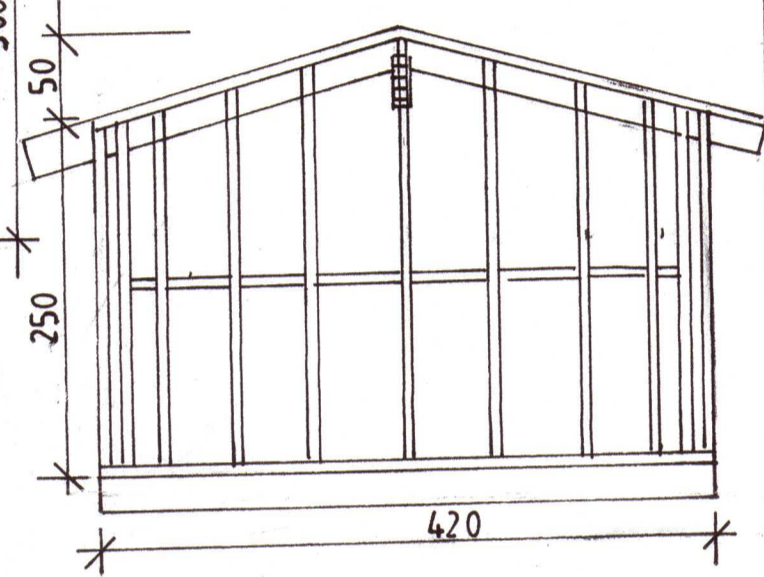
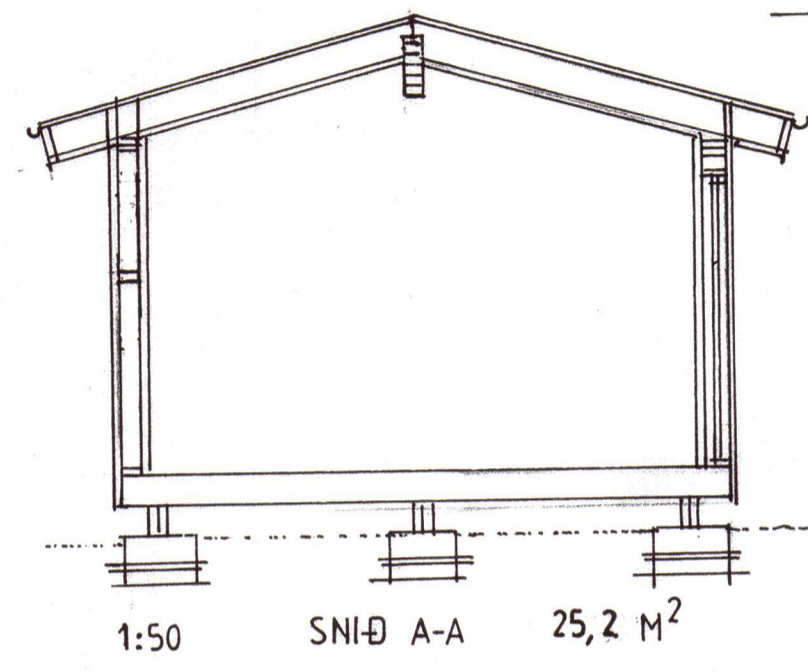
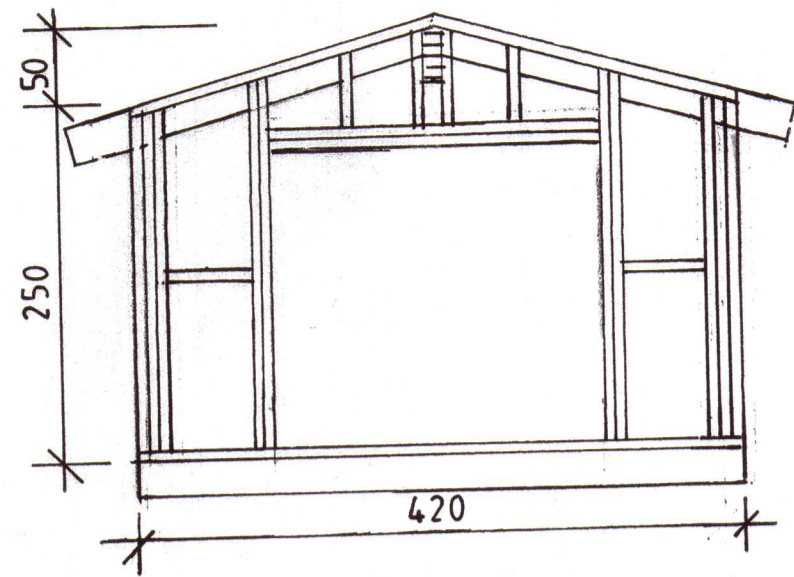
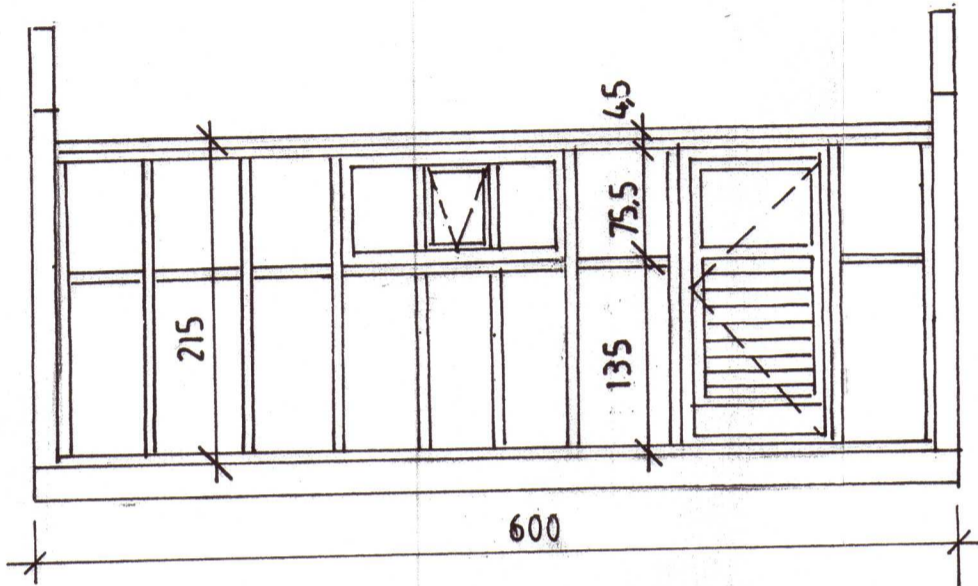
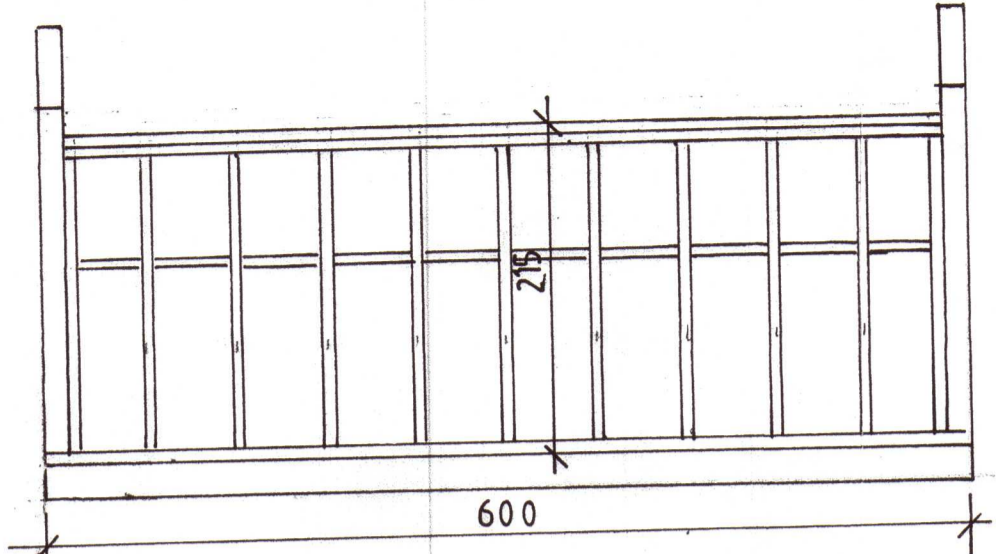
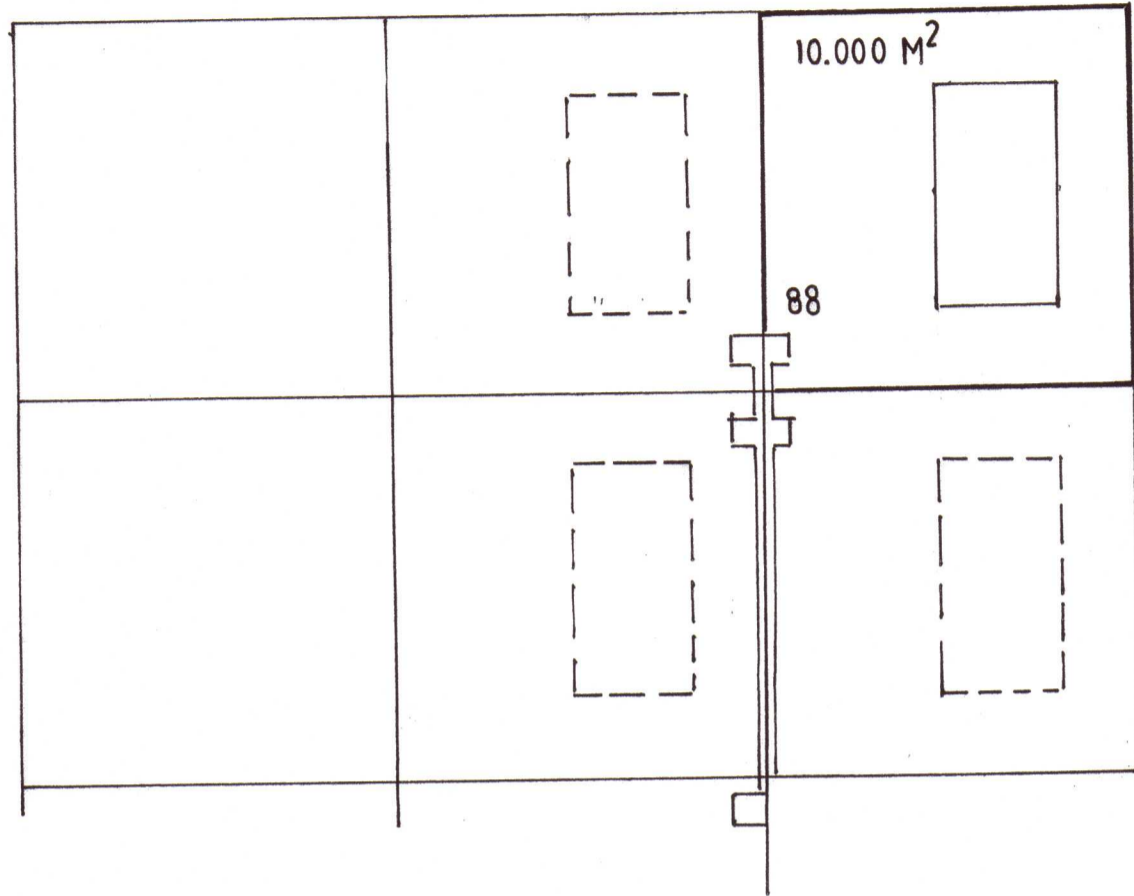
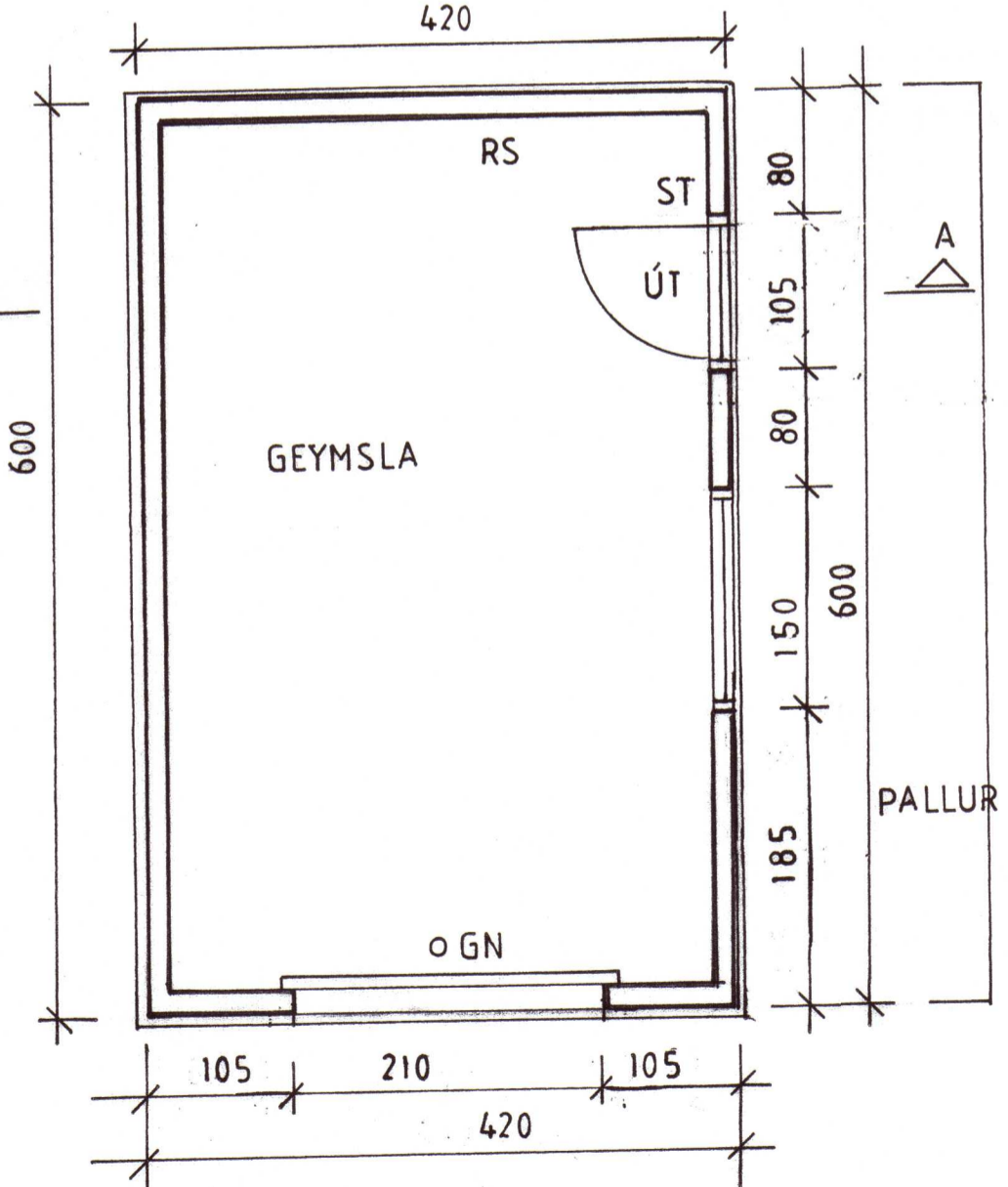
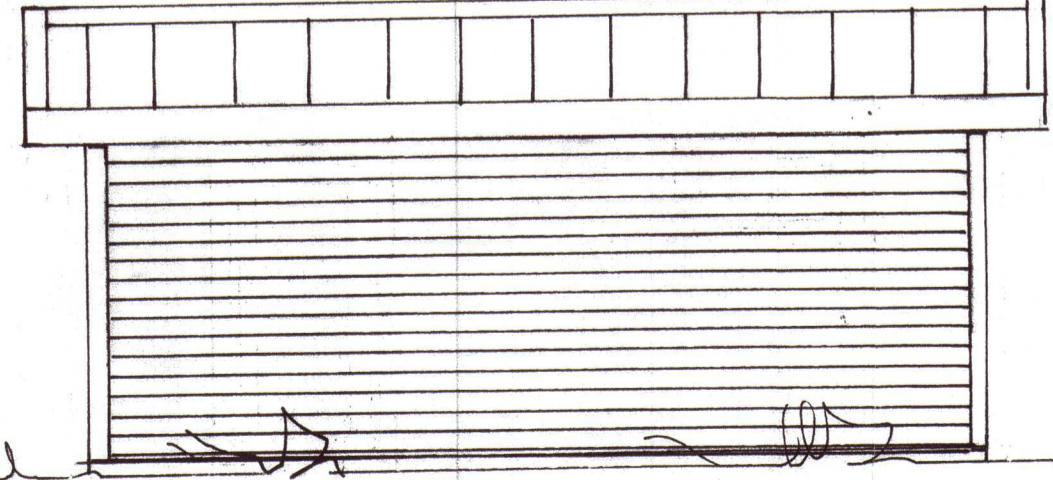
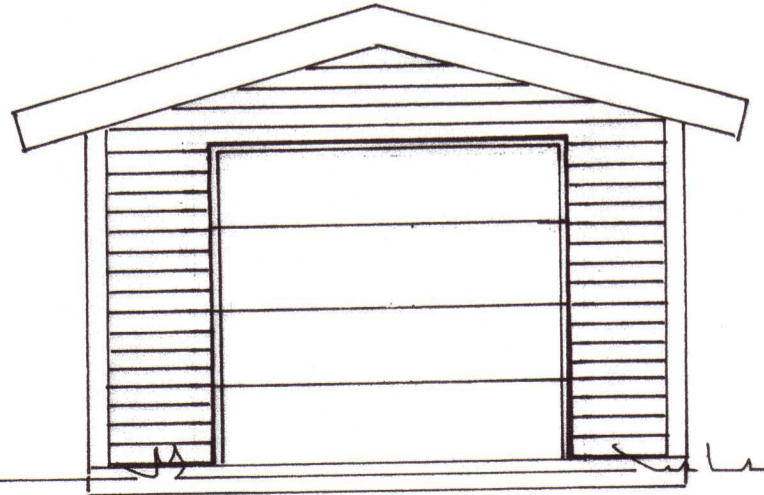

2020 854

Geymsla við áður byggt
 sumarhús Klöjberg 88 Grímanes og Grafningehreppi
 Grunnmynd, útlit, sniðmynd
 Grindartekning

ABS
 -teiknistofa-
 Jónannes Pálmarsson
 Sí. 01840-3939
 Sí. 567-5197
 Sigurður Sigurðsson
 Sí. 01840-3939
 Sí. 566-6123

Höfundur: JP	Dagsetning: 25.04.2020
Talning: JP	Mæki: 1:50
Skýring: JP	Út. lánaðgr: GR-01