

Umhverfis- og tæknisvið Uppsveita
Yfirfarið
 04. Mars 2022
David Björnsson
 Byggingarfulltrúi

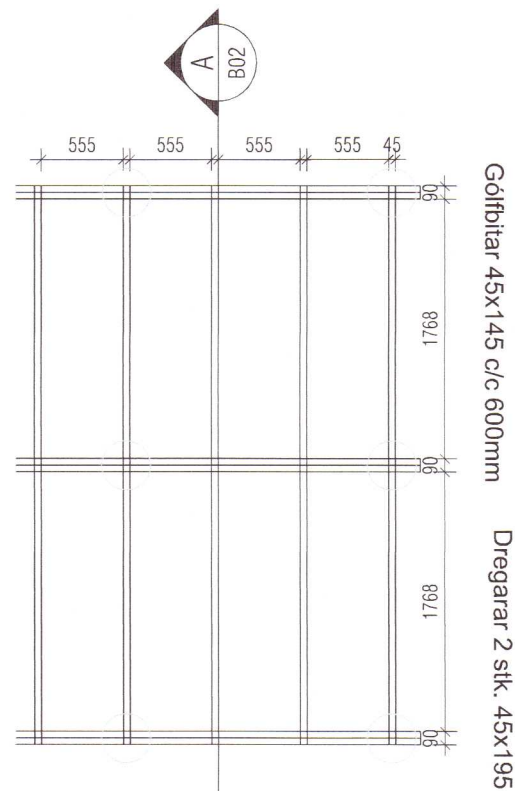

GRUNNMYND GÓLFBITA
 Mkv. 1:50

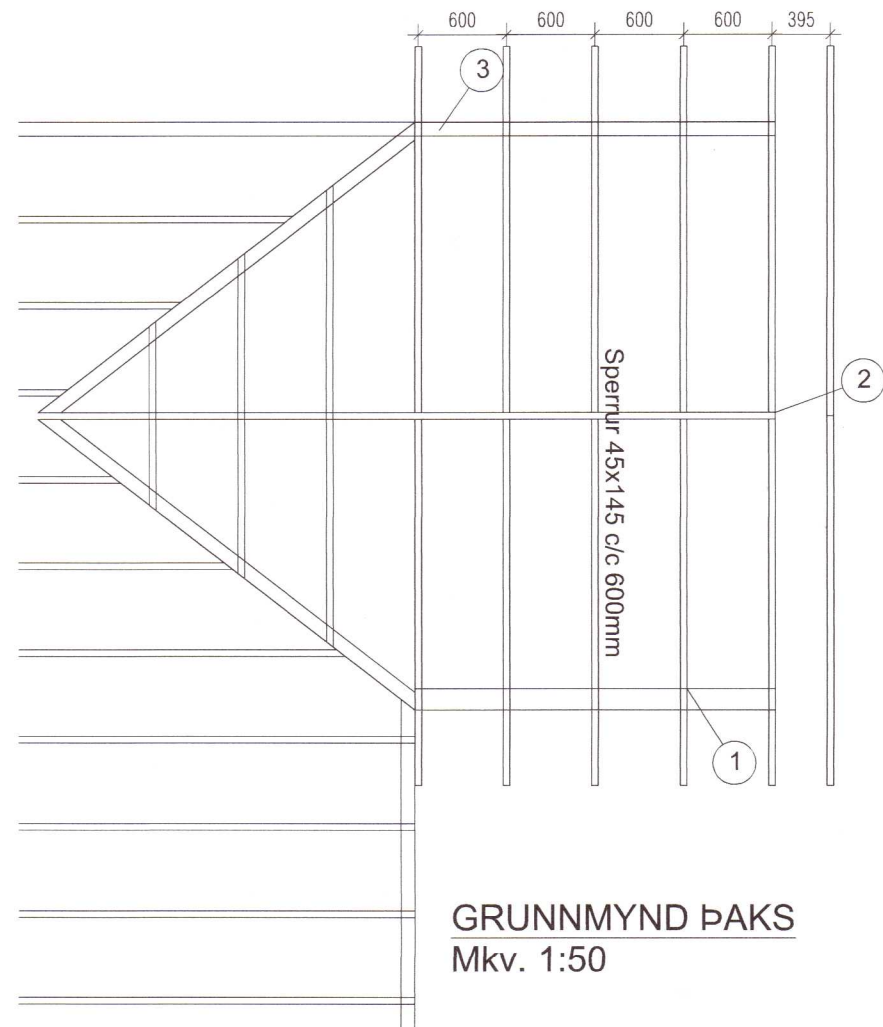

GRUNNMYND ÞAKS
 Mkv. 1:50

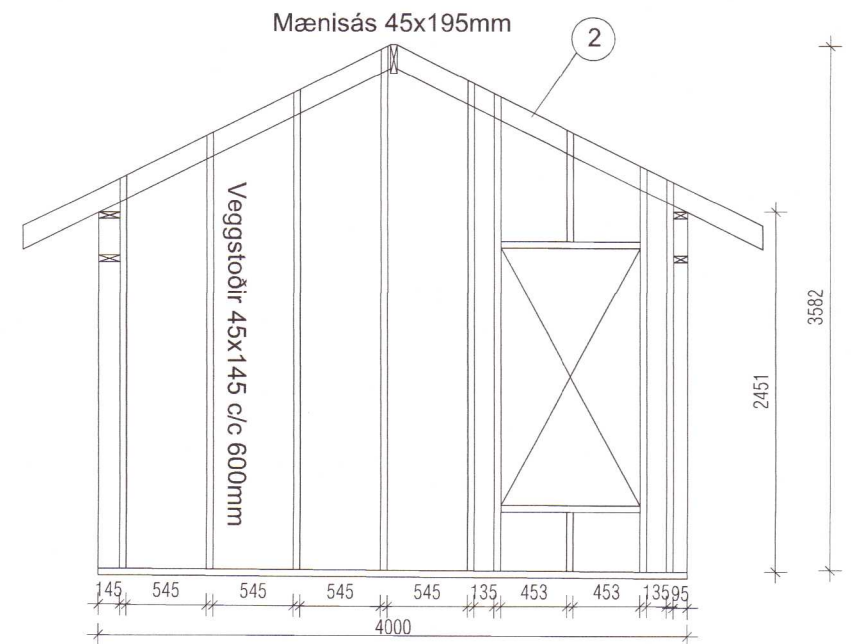
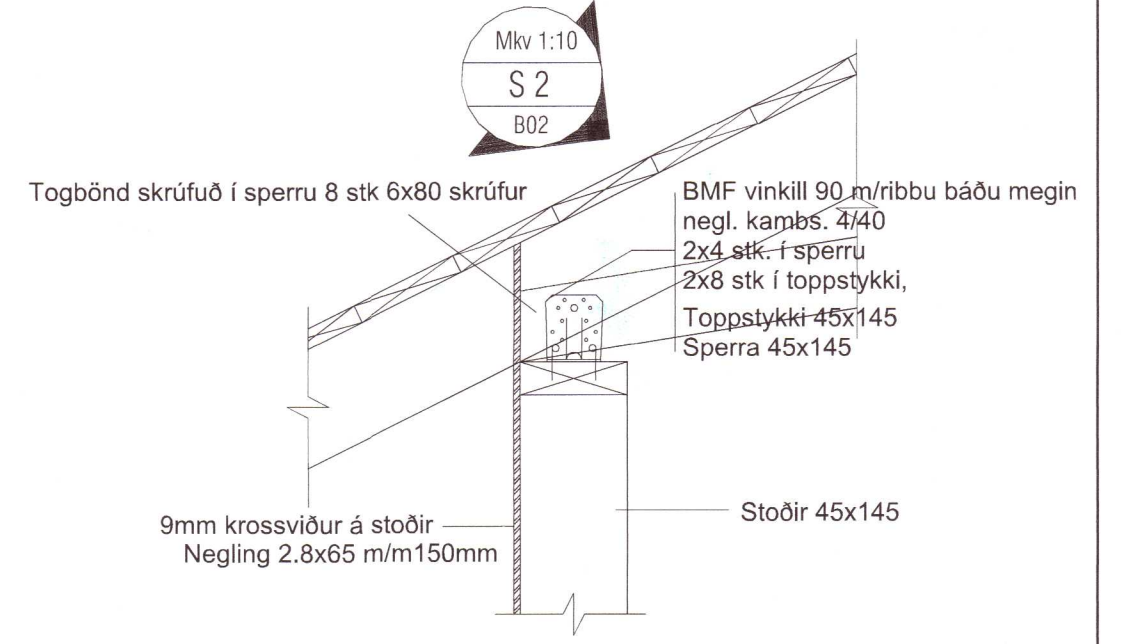
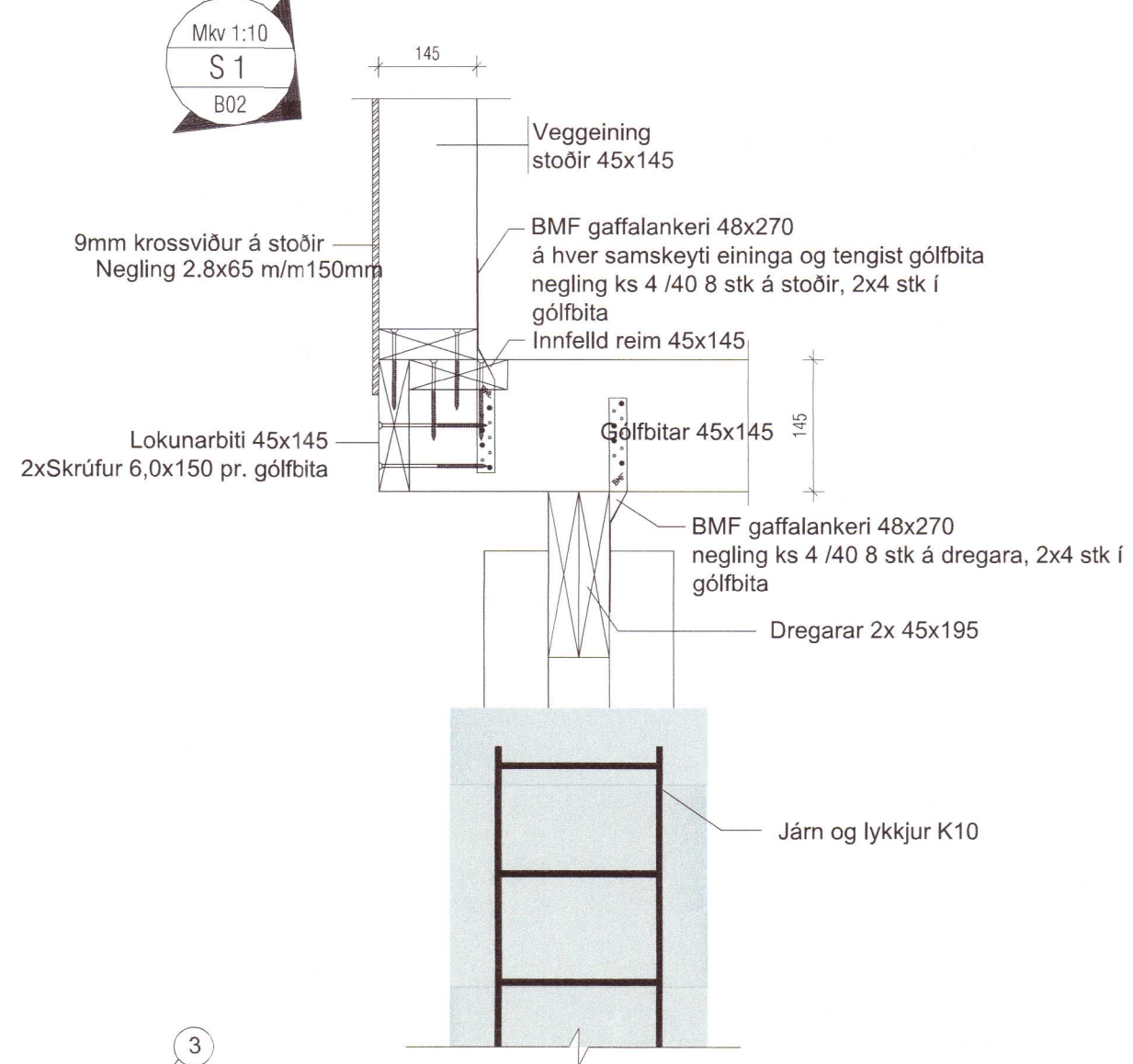

ÞVERSNIÐ A-A
 Mkv. 1:50

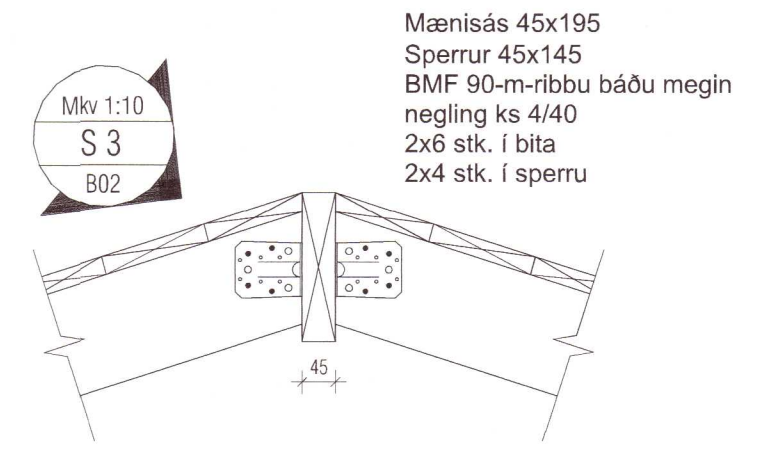
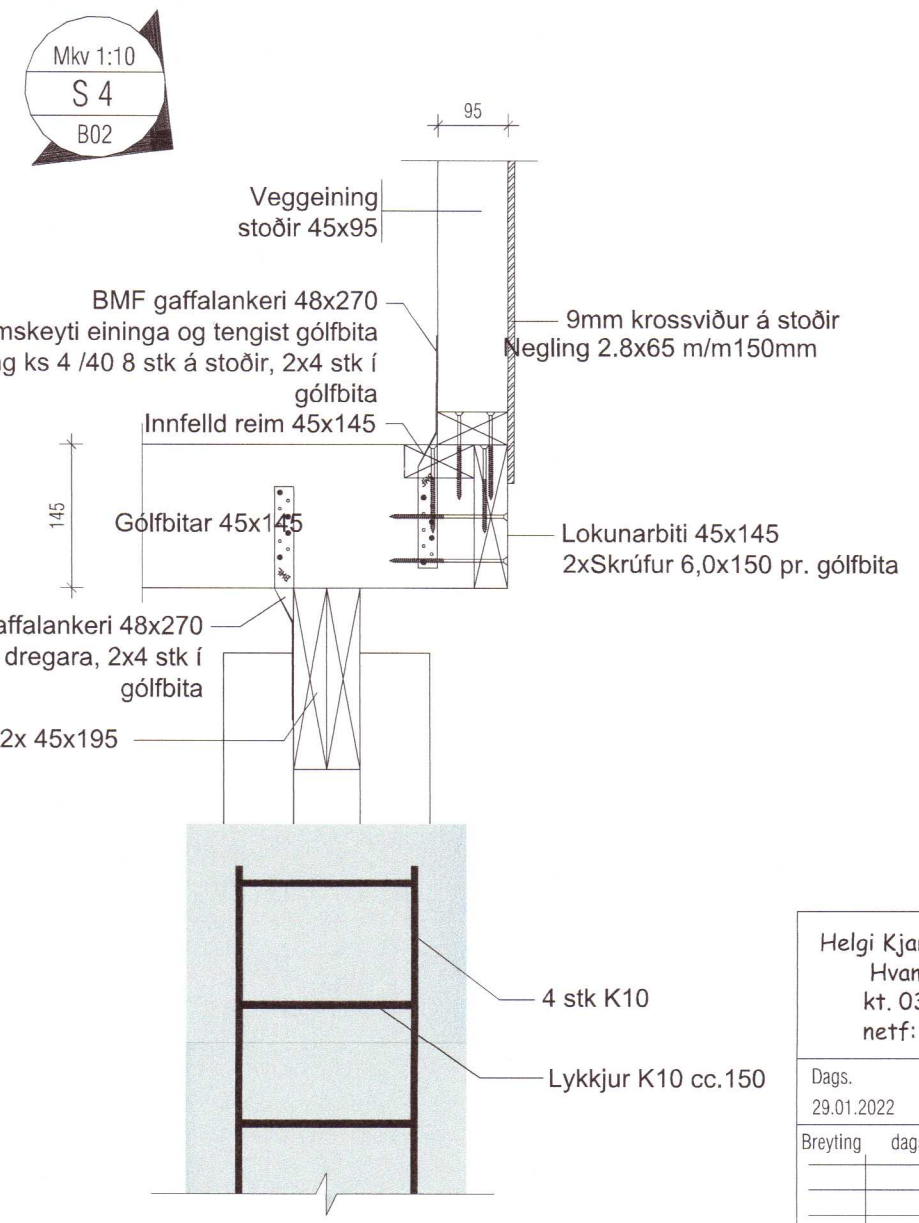
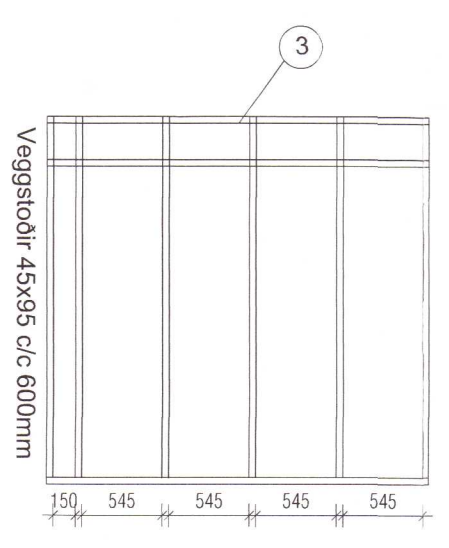
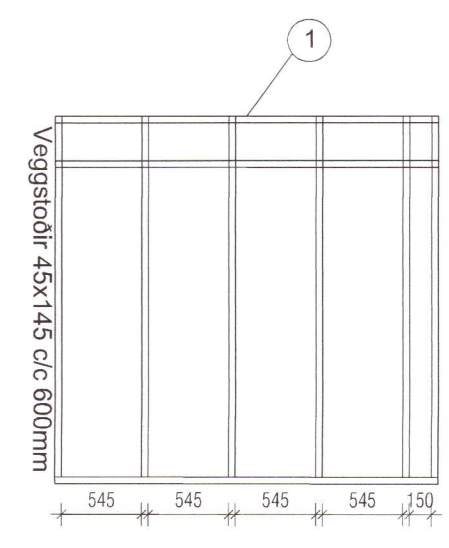

20220356

Helgi Kjartansson Byggingartæknifræðingur Hvammur 1b - 845 Flúðir kt. 030270-5419 - s: 617-5377 netf: helgikjartansson@gmail.com				Verkheiti Heiðarbyggð D-6 Viðbygging við sumarhús Burðarvirki
Dags. 29.01.2022	Teikn. Nr. B-01	Mkv. 1:50 / 1:10	Skrá .dwg	Aðalhönnuður 0302705419 <i>Helgi Kjartansson</i>
Breyting	dags	eðli breytingar		Samþykkt