

Skipulags- og byggingarfulltrúi Uppsveita bs.
Yfirfarið
 28 MAÍ 2015
Hannað
 Byggingarfulltrúi

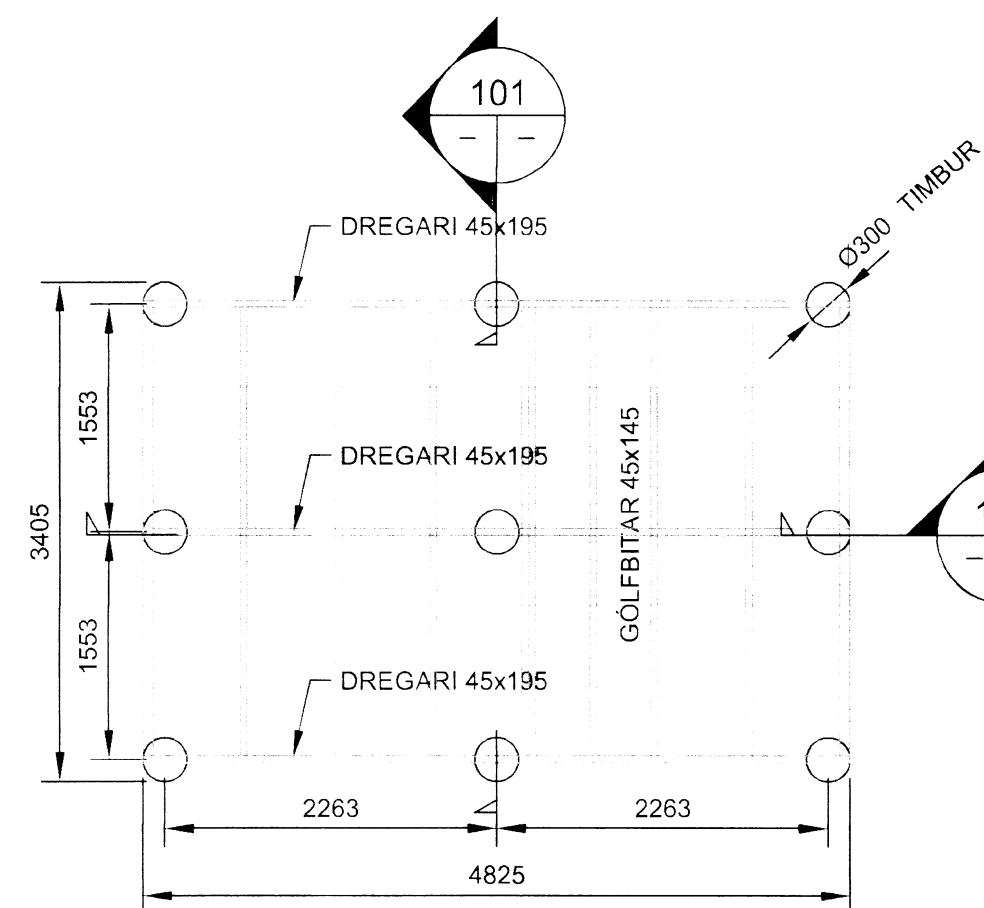

GRUNNMYND-UNDIRSTÖÐUR
MKV. 1

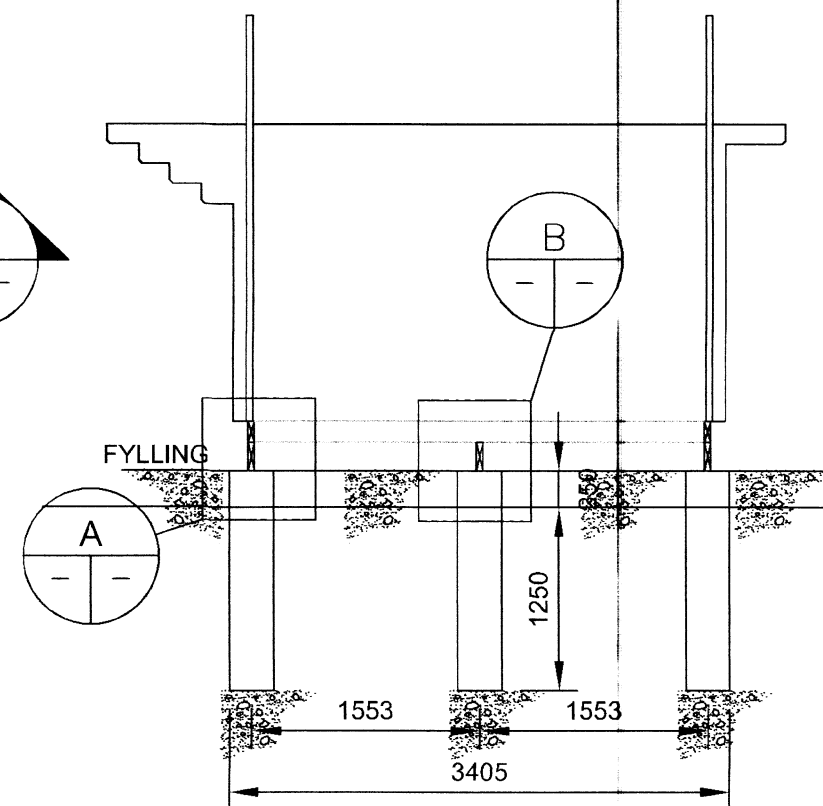

101 SNID
MKV. 1

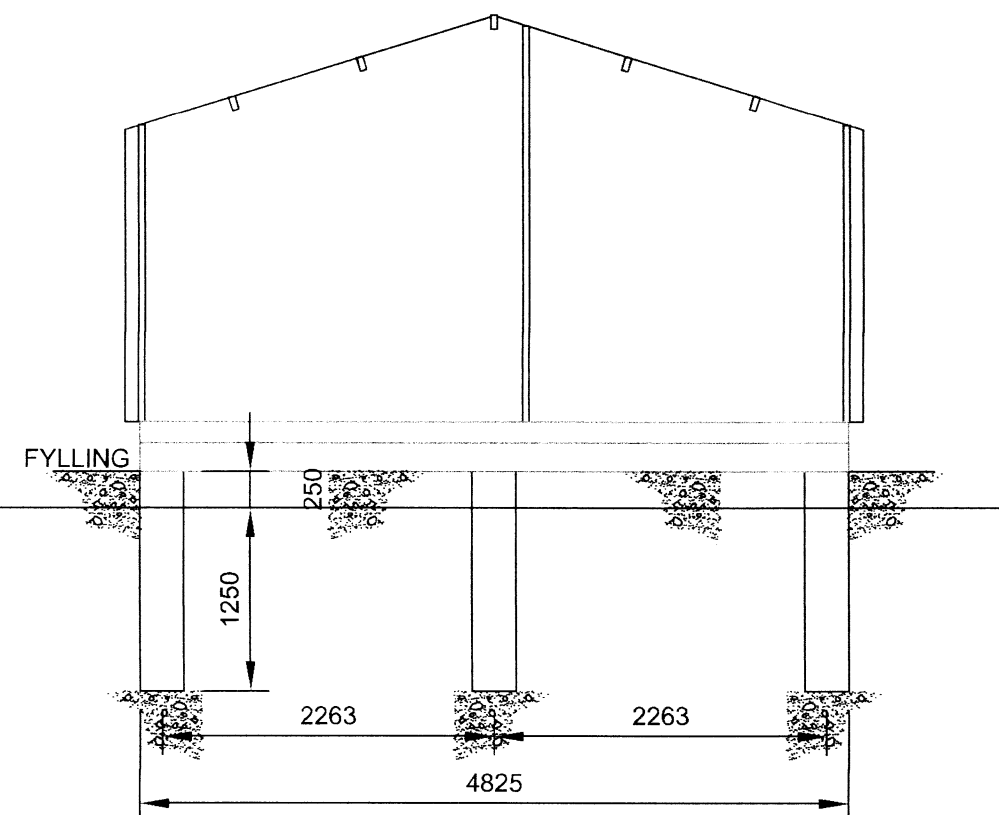

102 SNID
MKV. 1

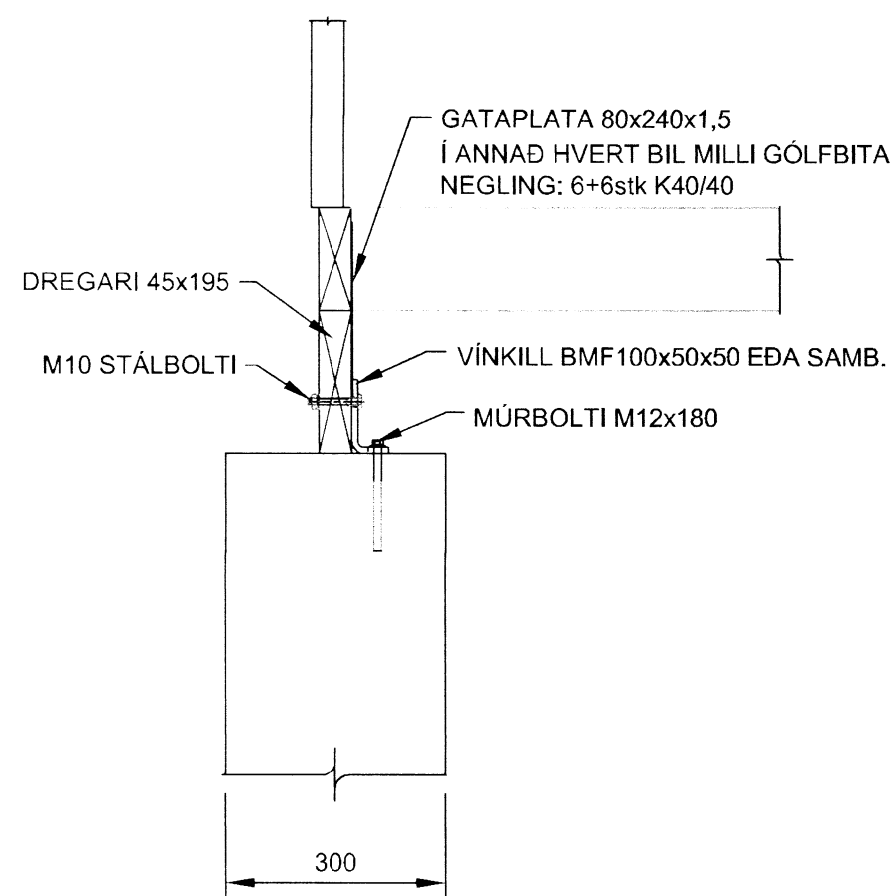

A DEILI
MKV. 2

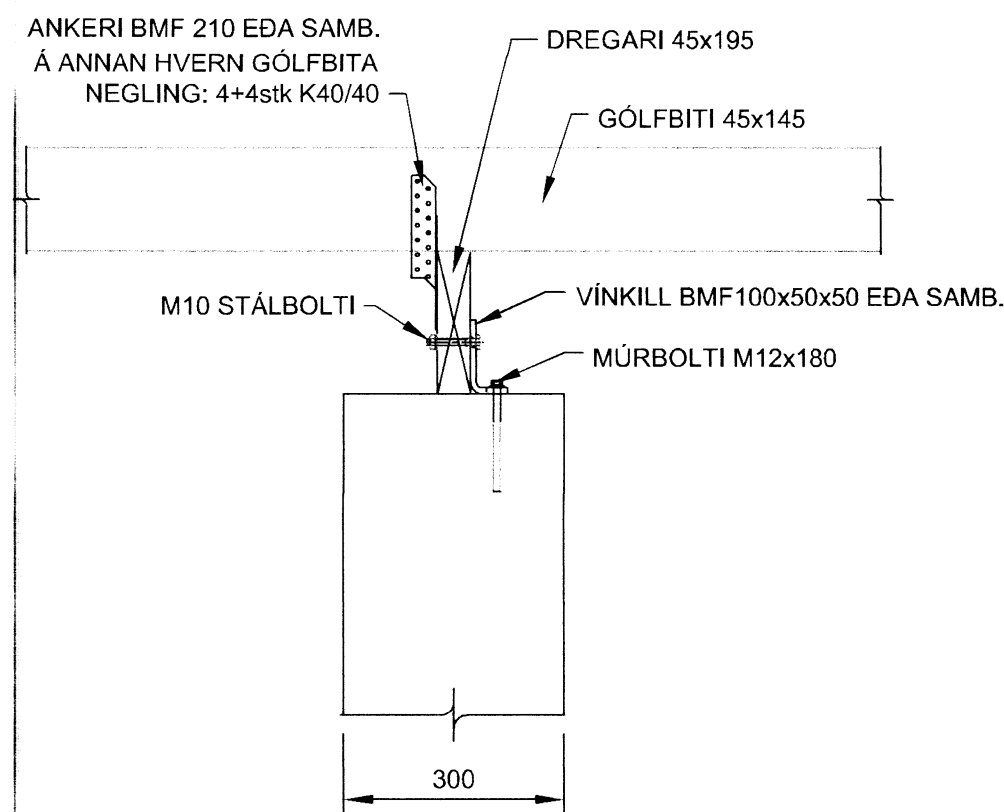

B DEILI
MKV. 2

SKRÝRINGAR:

1. ALMENNAR SKÝRINGAR SJÁ TEIKNINGU B100
2. MESTA ÁLAG FRÁ UNDIRSTÖÐU ER 0,3 MN/m²

MKV. 1

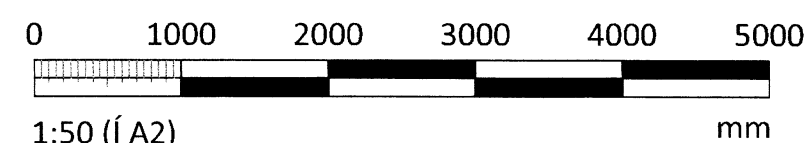

MKV. 2

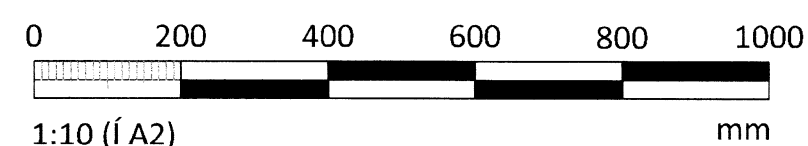

Verkefni:		
Frístundahús		
Heimilisfang:		
Syðri Reykir, Biskupstungum - Lóð 167449		
Teikning:	Hannað: GSS	
Burðarvirki	Teiknað: GSS	
Undirstöður	Mælikvarði: Br.	
-	Bláðastærð: A2	
-	Dags.: 1.5.2015	
-	Verk. Nr.: 160315	
Undirskrift og kennitala hönnuðar:		
Guðni Sigurbjörn Sigurðsson Kt. 250582/4479		
Undirskrift og kennitala hönnunarstjóra:		
Guðni S. Sigurðsson	Teikning nr.	Útgáfa
Selás 13, 260 Reykjanesbæ	B101	-
Sími: 868-0528		
Netfang: www.riss.is		
HÖNNUÐUR ÁSKILUR SER ALLAN RÉTT Á TEIKNINGUM - FJÓLFÓLDUN ER HÁÐ SKRIFLEGU SAMÞYKKI		