

UH 01 8.stk
 Ásýnd/ Grunnmynd 1:20

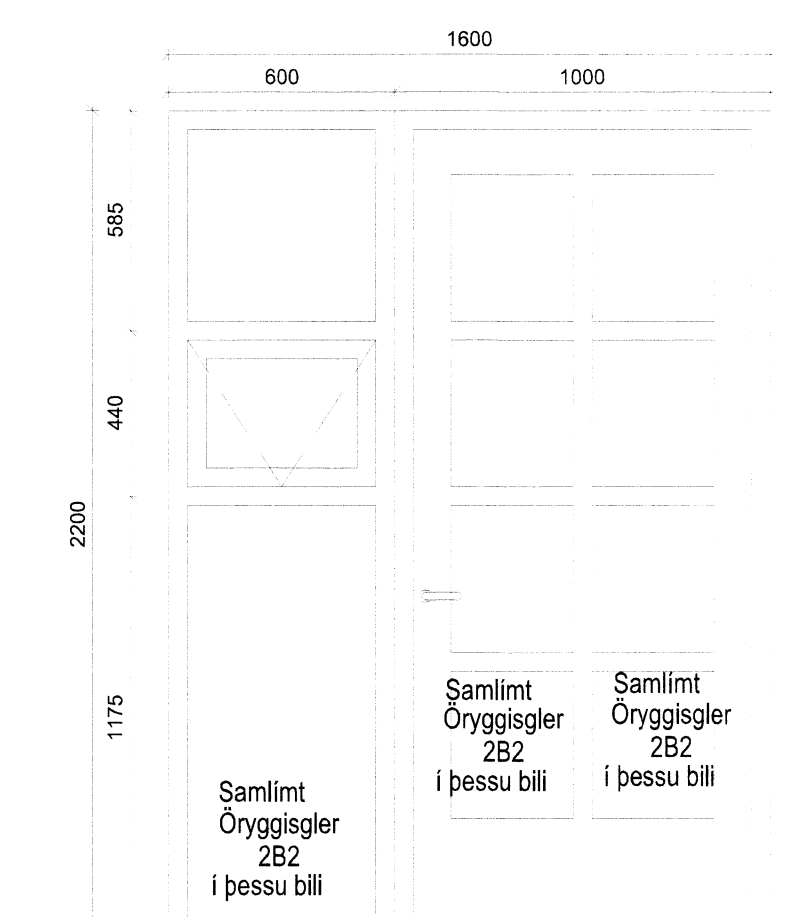

UH 02 7.stk
 Ásýnd/ Grunnmynd 1:20



UH 03 1.stk
 Ásýnd/ Grunnmynd 1:20

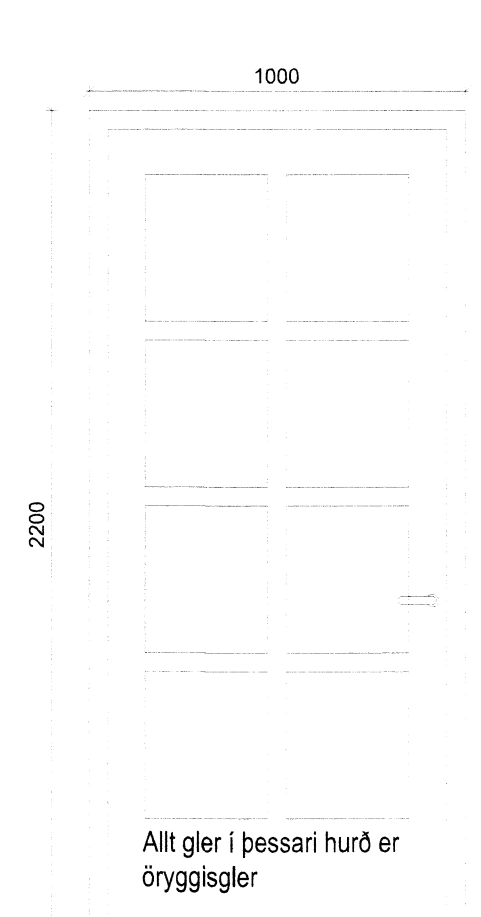

UH 04 1.stk
 Ásýnd/ Grunnmynd 1:20

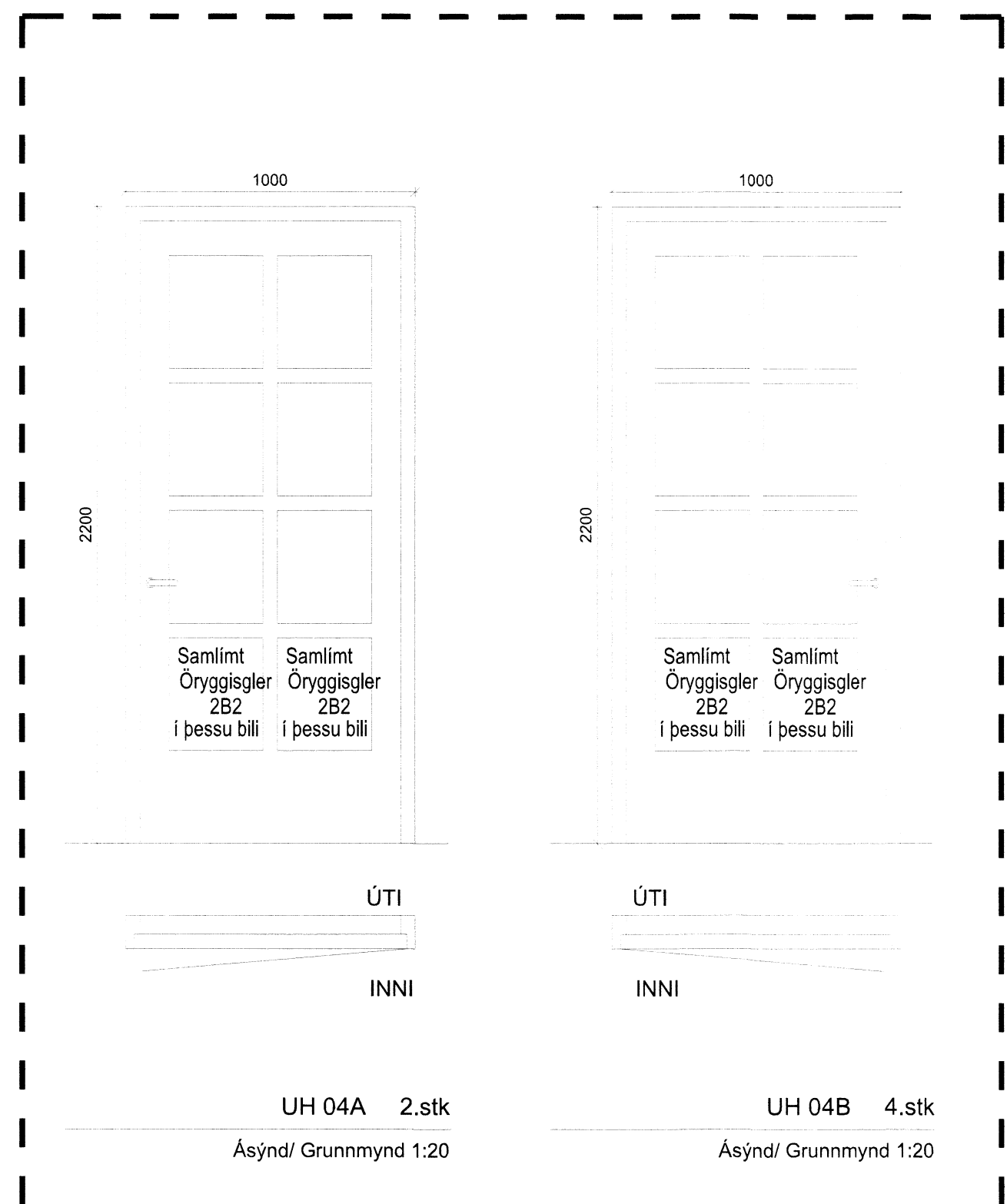

UH 04A 2.stk
 Ásýnd/ Grunnmynd 1:20

UH 04B 4.stk
 Ásýnd/ Grunnmynd 1:20

ÞESSAR HURÐIR OPNAST INN - ALLAR ADRAR HURÐIR OPNAST ÚT

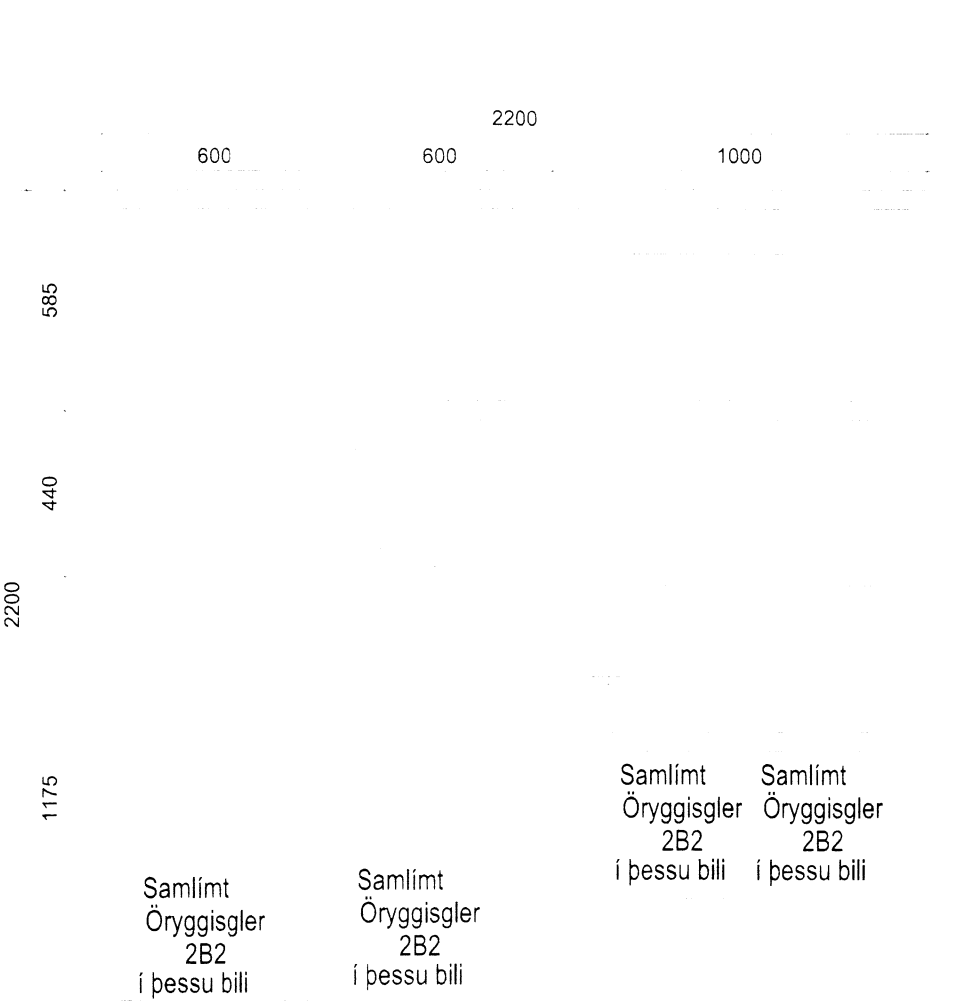

UH 05 1.stk
 Ásýnd/ Grunnmynd 1:20

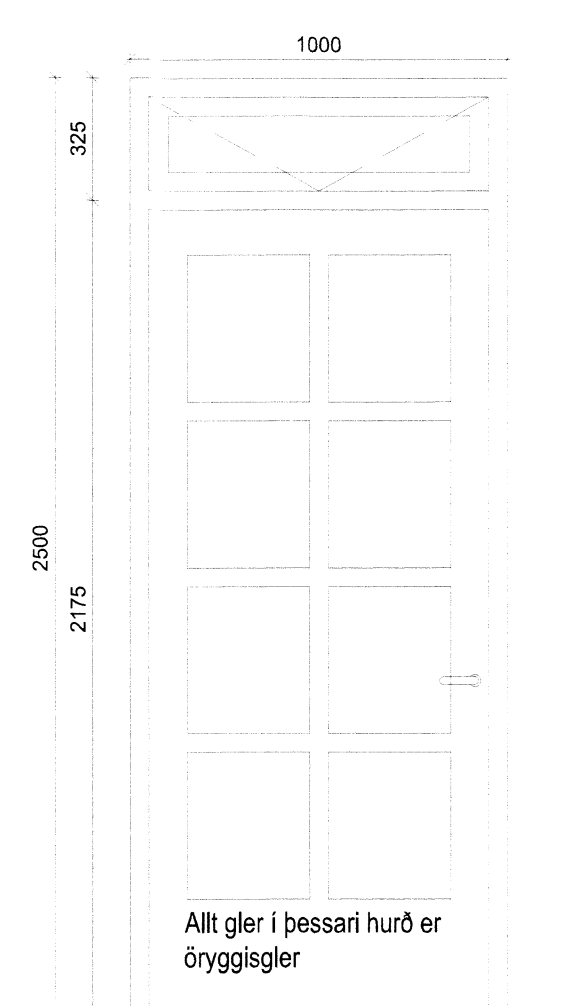

UH 06 1.stk
 Ásýnd/ Grunnmynd 1:20

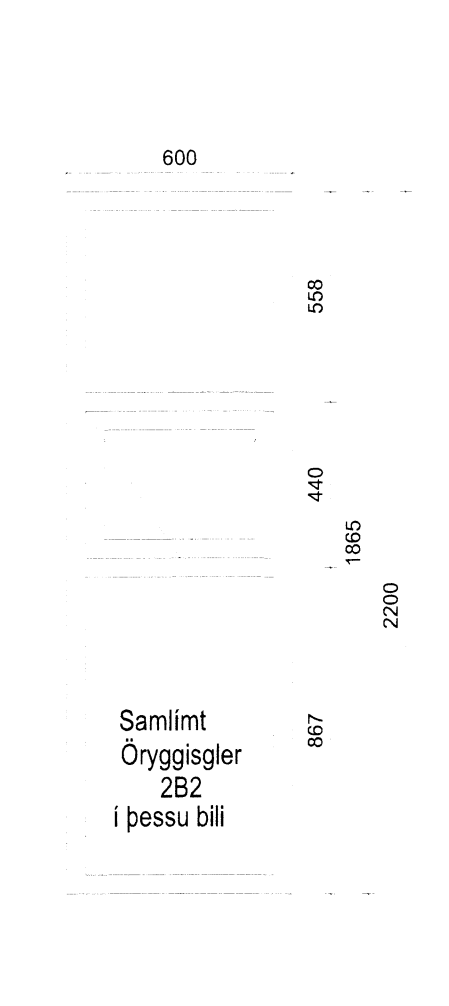

GL 01 2.stk
 Ásýnd/ Grunnmynd 1:20

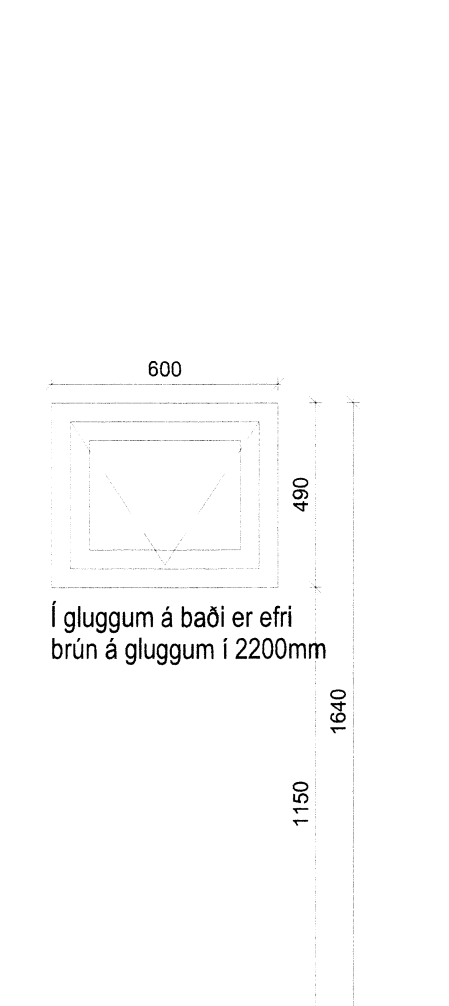

GL 02 4.stk
 Ásýnd/ Grunnmynd 1:20

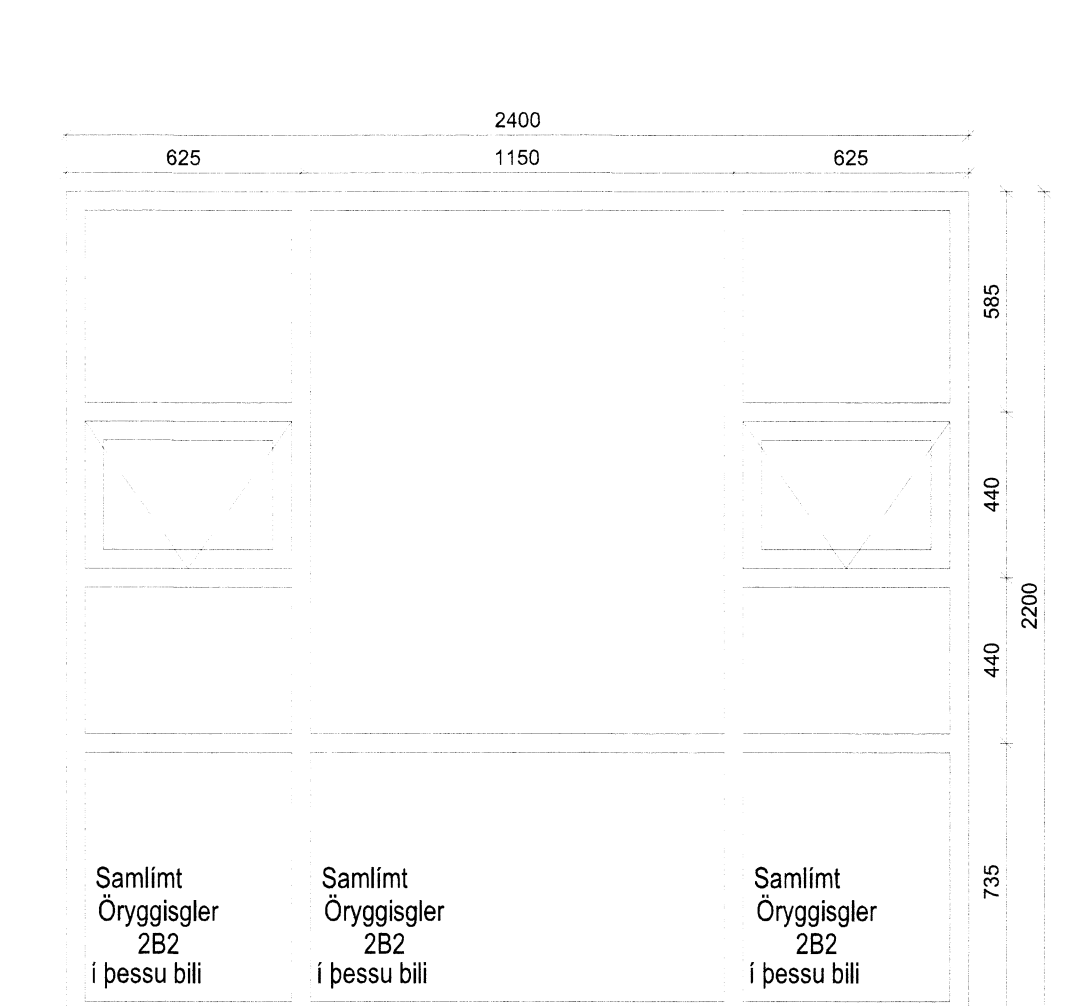

GL 03 6.stk
 Ásýnd/ Grunnmynd 1:20

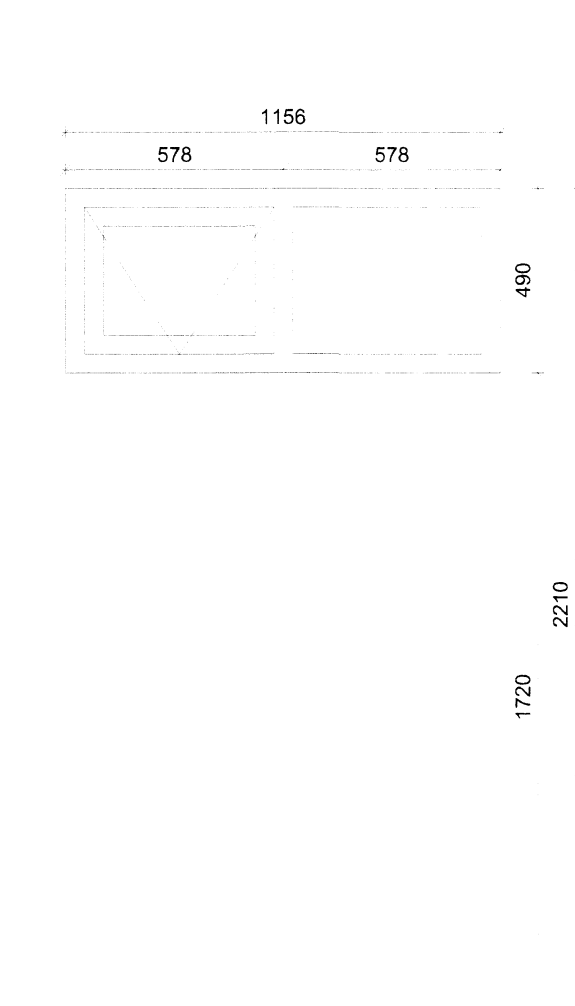

GL 04 4.stk
 Ásýnd/ Grunnmynd 1:20

Gluggar áklæddir timburgluggar Samlimt öryggisgler 2 (B)2 samkvæmt reglugerð í þeim herbergjum sem eru ætluð hreyfihömluðum má hæð á þröskuldi ekki vera hærrí en 20mm. Það sama á um báðar inngangshurðir. Uppgefin mál eru smíðamál glugga ,op í veggjagrindum eru 20mm stærri. Fritt ljósmál í flóttahurðum eru 870mm

B1 19.12.2014 ný hurðartýpa UH04A OG UH4B	dg
Utg. Daga. Skýring	Br. at:
Ásborgir 23 801 Selfoss Hurðir og gluggar	
Teiknað af: dg	Dagsetning: 17.11.2014
Yfirfarir af: okf	Mælikvarði: 1:20
Halldór Guðmundsson 140548-2439 Frey Frostason 170470-4869 Ólafur K. Fimhjánnason 230295-3229 Ragnar Auðunn Birgisson 230160-4499 Samuél Guðmundsson 011063-4039	