

Samþykkt  
 4. SEPTEMBER 2007  
 Hönnun  
 Byggingarútlit og útskýringar

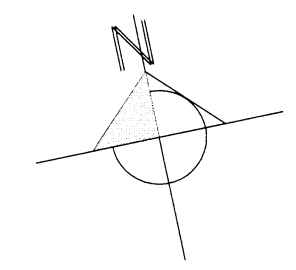

- SKÝRINGAR:
- SL SLOKKVITÆKI
  - RS REYKSKYNJARI
  - BO BJÖRGUNAROP
  - GNF GEGNUMSTREYMISNIÐURFALL
  - NF NIÐURFALL
  - LR LOFTRÆSTING
  - ☉ HÆÐARKÓTAR Á GRUNNMYND
  - 27.56 HÆÐARKÓTAR Á SNIÐI
  - 0101 NOTEINGANÚMÉR

**Pro-Ark teiknistofa**  
 Austurvegi 69, 800 Selfoss Sími 482 4430 Fax 482 4435 proark@proark.is

hönnun skipulag áætlanir eignaumsjón

Eiríkur Vignir Pálsson BFI Kt:010975-4179 Kjartan Sigurbjartsson BFI Kt:190275-5319

Verk. **Holtabyggð 10.**  
**Sumahús mhl 07 & 08**

Teikn. **Grunnmynd og sniðteikning**

Hann. EVP / K.Sig Teiknad. K.Sig Mkv. 1:100

Verknr. 07-011 Dags. Ágúst 2007 Teikninnr. **A-101** Útgáfa **A**

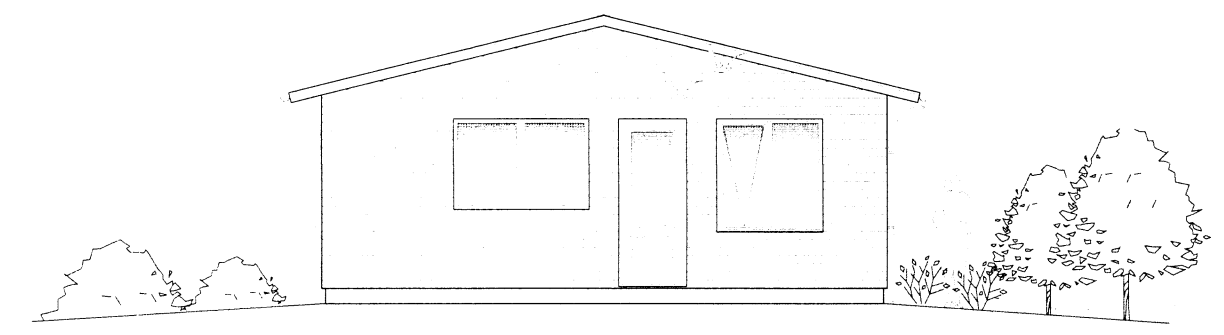

Suðlæg hlíð  
Mkv. 1:100

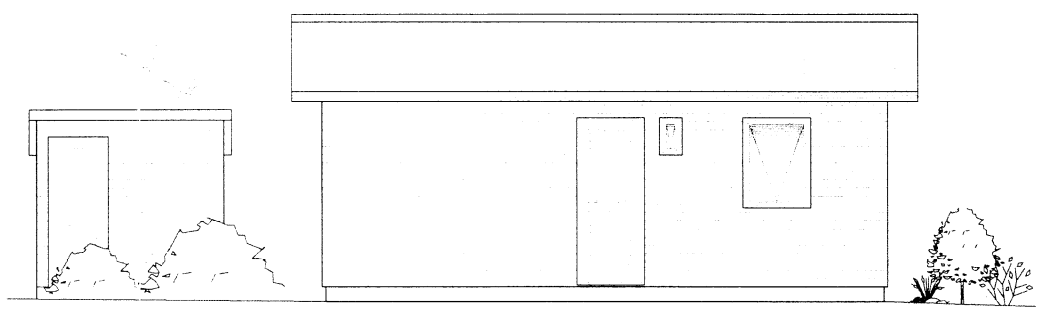

Vestlæg hlíð  
Mkv. 1:100

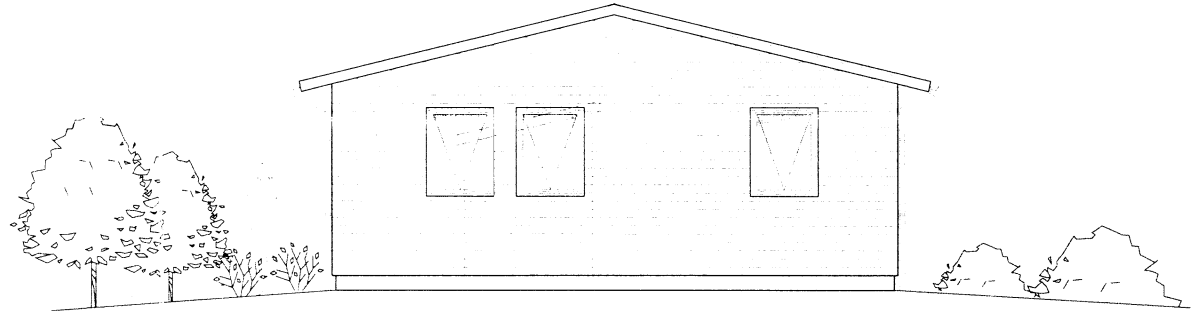

Norðlæg hlíð  
Mkv. 1:100

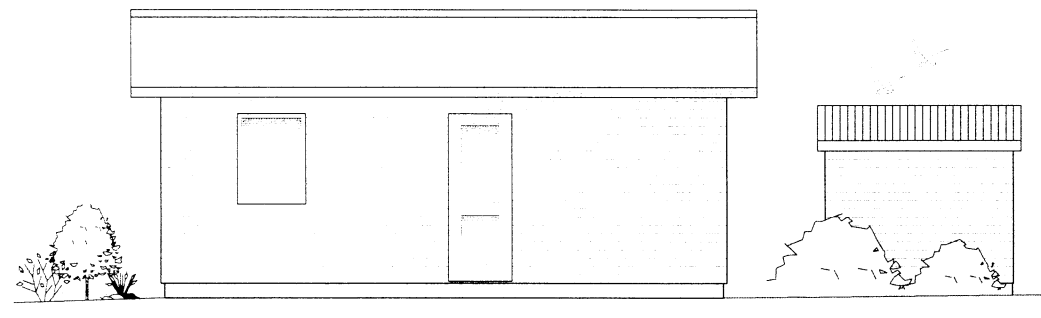

Austlæg hlíð  
Mkv. 1:100

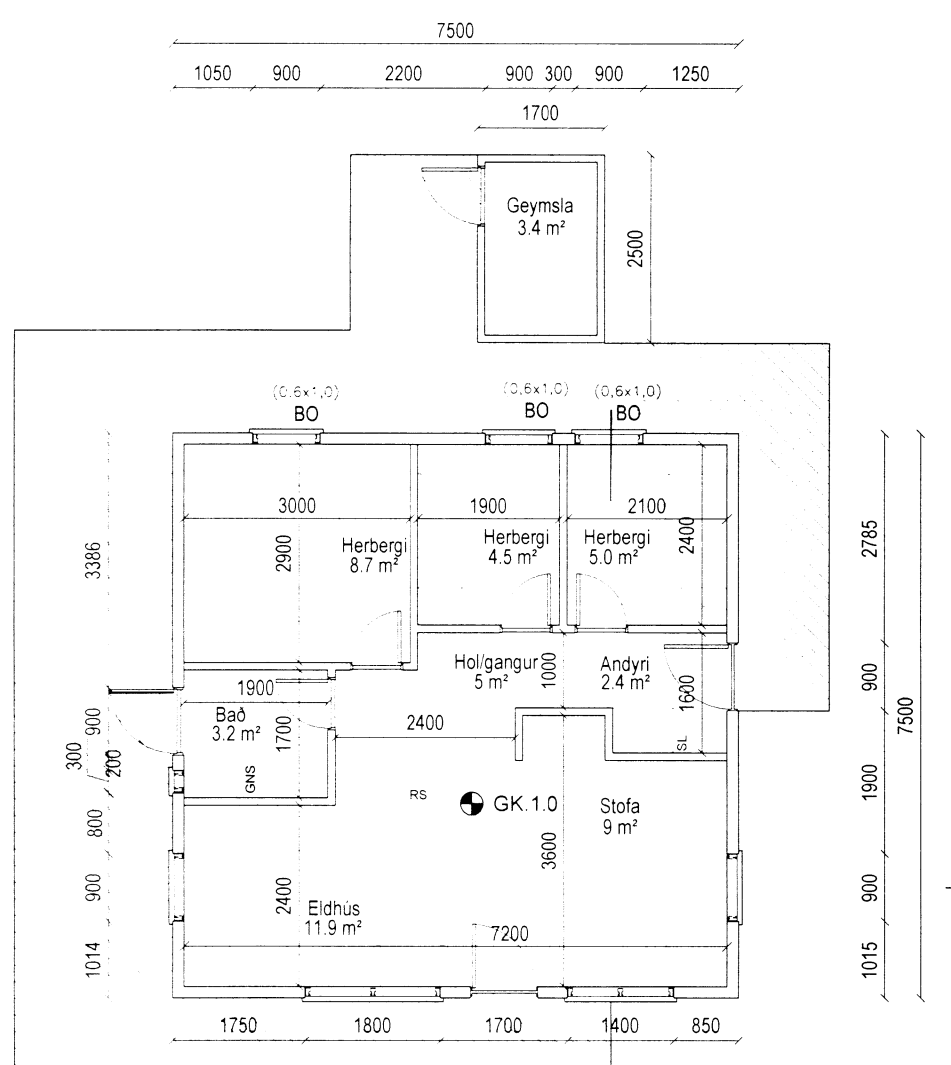

Grunnmynd  
Mkv. 1:100

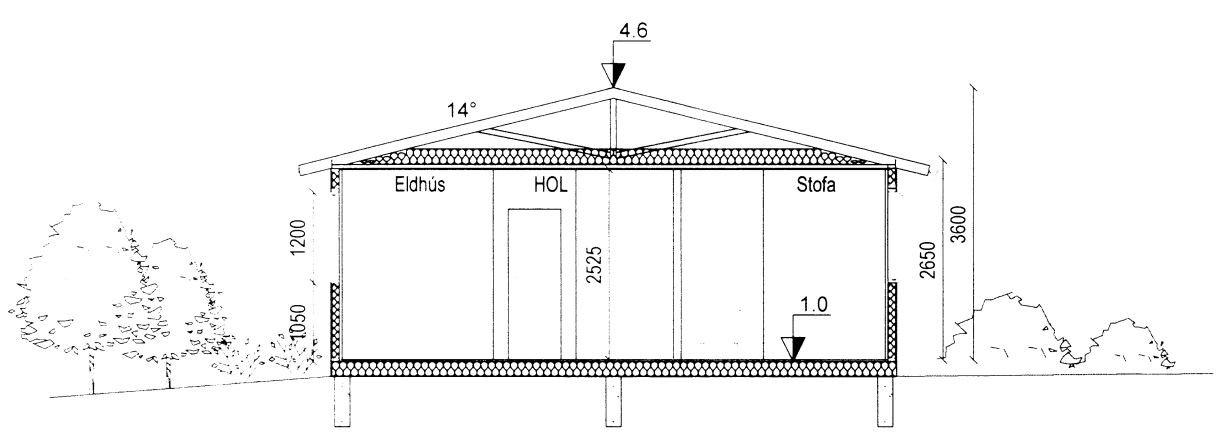

Snið A-A  
Mkv. 1:100

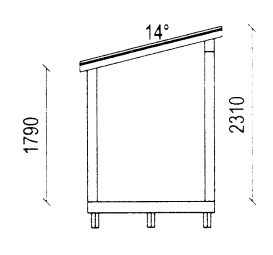

Snið i Geymslu  
Mkv. 1:100

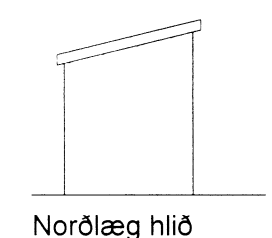

Norðlæg hlíð  
Mkv. 1:100