

Samþykkt
 9. AUGÚST 2007
Hilmar Einarsson
 Höfuðstjórnuneyðingarmáttur Átt. v. 1984

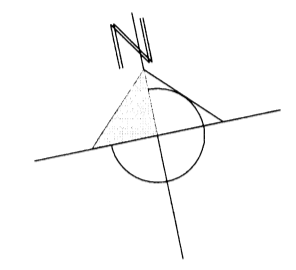

- SKÝRINGAR:
- SL SLOKKVITÆKI
 - RS REYKSKYNJARI
 - BO BJÖRGUNAROP
 - GNF GEGNUMSTREYMISNIÐURFALL
 - NF NIÐURFALL
 - LR LOFTRÆSTING
 - ☉ HÆÐARKÓTAR Á GRUNNMYND
 - ☼ 27.56 HÆÐARKÓTAR Á SNIÐI
 - 0101 NOTEINGANUMER

Pro-Ark teiknistofa
 Austurvegi 69, 800 Selfoss Sími 482 4430 Fax 482 4435 proark@proark.is

hönnun skipulag áætlanir eignaumsjón

Eiríkur Vignir Pálsson BFI Kt:010975-4179
 Kjartan Sigurbjartsson BFI Kt:190275-5319

Verk. **Holtabyggð 10.**
 Sumahús mhl 09 & 10

Teikn. **Grunnmynd og sniðteikning**

Hann. EVP / K.Sig Teiknad. K.Sig Mkv. 1:100

Verknr. 07-011 Dags. Ágúst 2007 Teikninnr. **A-101** Útgáfa **A**

5803

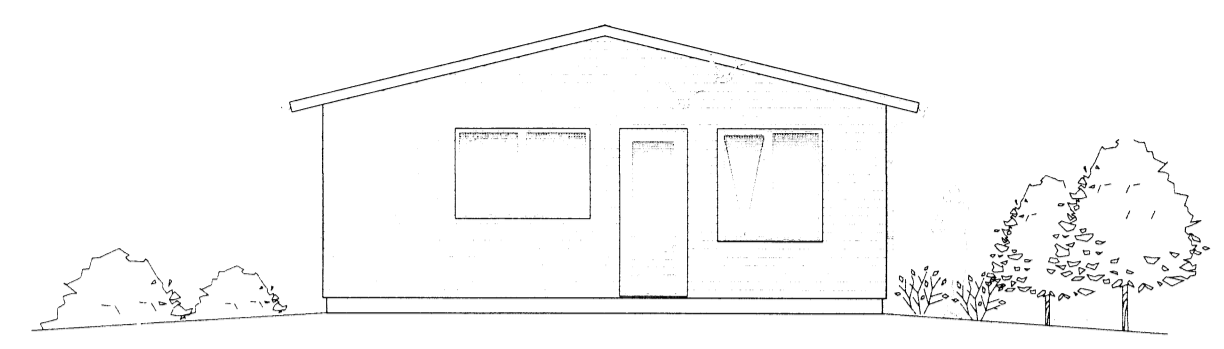

Suðlæg hlið
 Mkv. 1:100

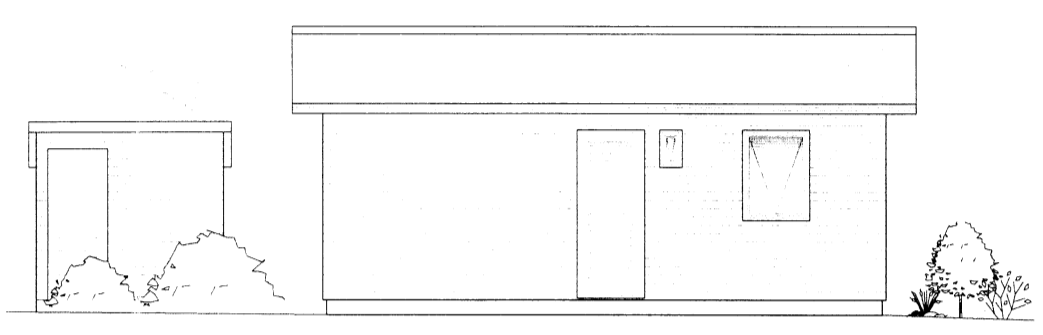

Vestlæg hlið
 Mkv. 1:100

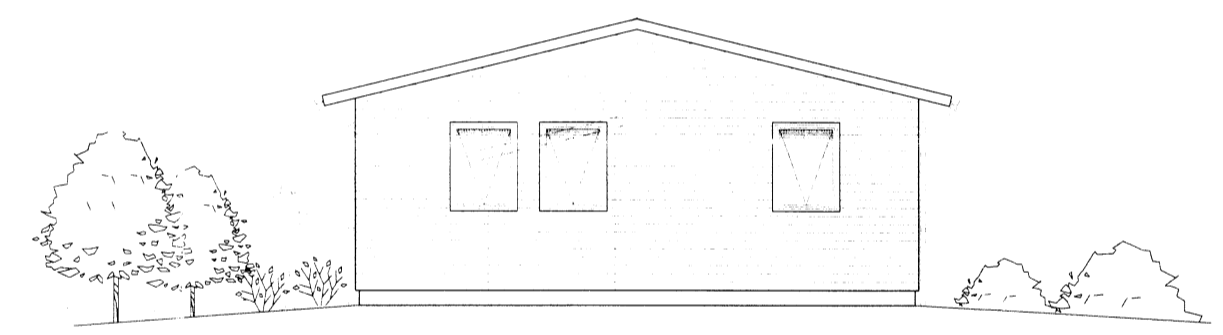

Norðlæg hlið
 Mkv. 1:100

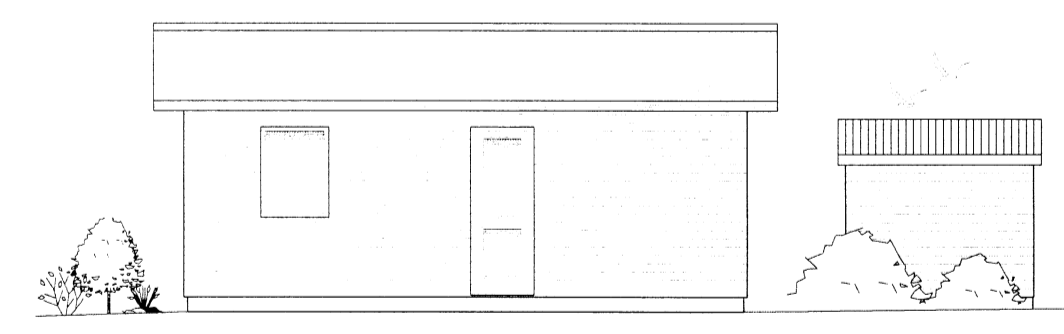

Austlæg hlið
 Mkv. 1:100

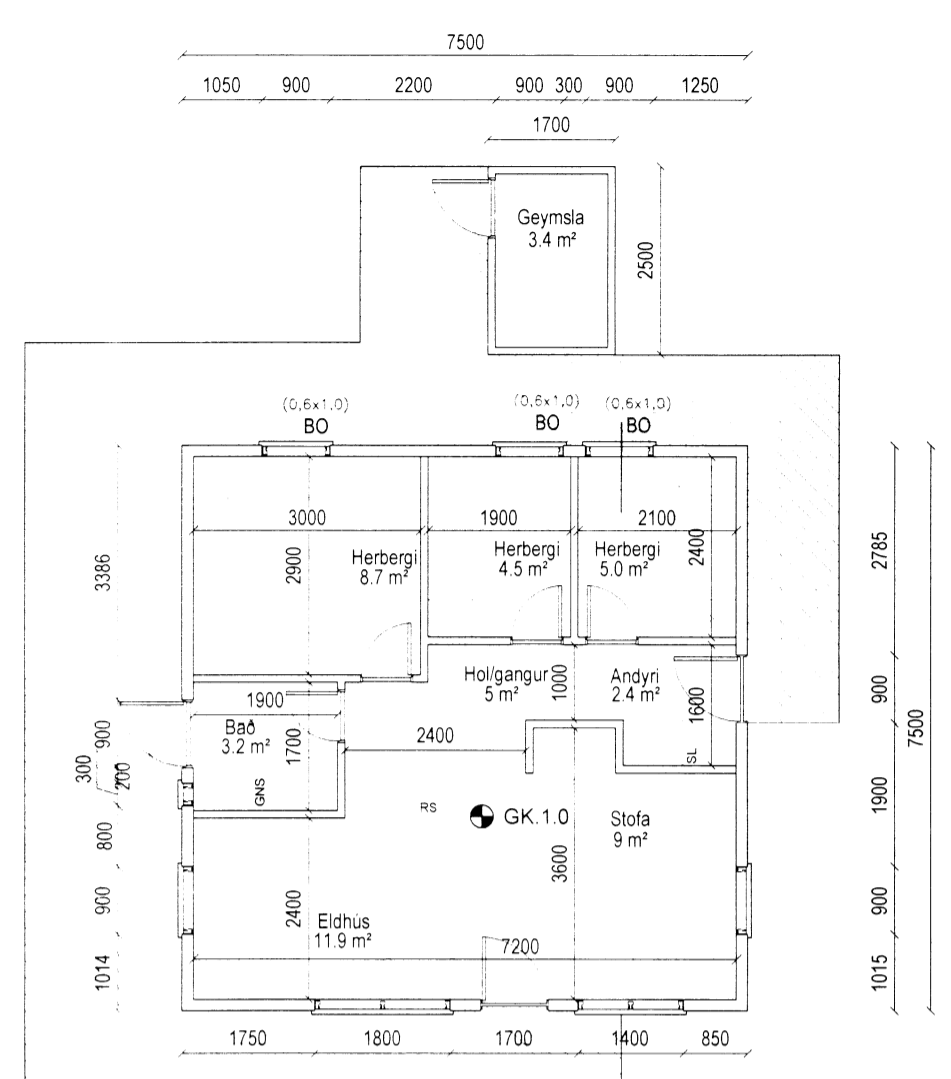

Grunnmynd
 Mkv. 1:100

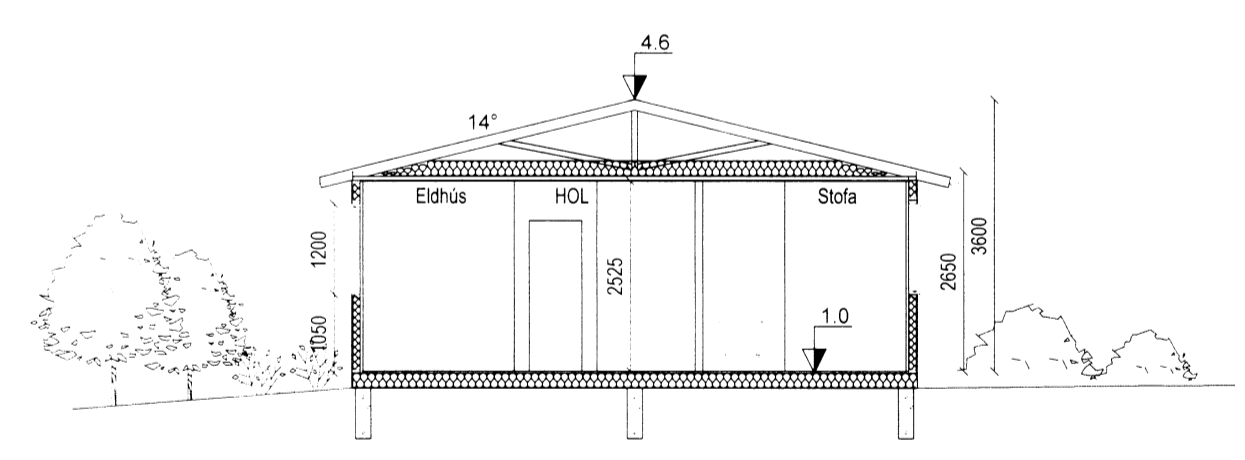

Snið A-A
 Mkv. 1:100

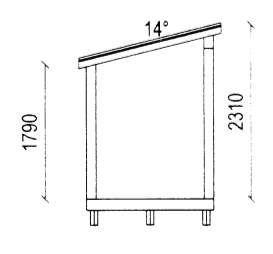

Snið í Geymslu
 Mkv. 1:100

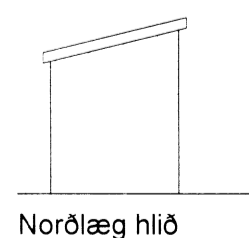

Norðlæg hlið
 Mkv. 1:100