

Sambykkt
 04.08.2007
Ólafur Lárusson
 Sýggingarfræðingur og hönnuður Árnýsveitinn

LITPRENTAÐ: 29.8.2007 12:53:47
 SÍÐAST VISTAÐ: 29.8.2007 12:43:56

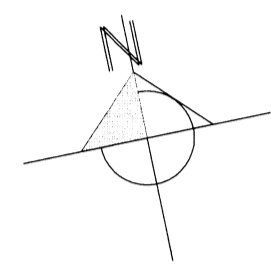

SKÝRINGAR:
 SL. SLOKKVITÆKI
 RS. REYKSKYNJARI
 BO. ÞJÓRGUNARÖP
 GN. GEGNUMSTREYMISNIÐURFALL
 NF. NIÐURFALL
 LR. LOFTRÆSTING
 HÆÐARKÓTAR Á GRUNNMYND
 27.56 HÆÐARKÓTAR Á SNIÐI
 0101 NOTEINGANÚMÉR

Pro-Ark teiknistofa
 Austurvegi 69, 800 Selfoss Sími 482 4430 Fax 482 4435 proark@proark.is
 hönnun skipulag áætlanir eignaumsjón

Eiríkur Vignir Pálsson BFI Kt:010975-4179
 Kjartan Sigurbjartsson BFI Kt:190275-5319

Verk. **Holtabyggð 10.**
Sumahús mhl 03 & 04

Teikn. **Grunnmynd og sniðteikning**

Hann. EVP / K.Sig Teiknad. K.Sig Mkv. 1:100

Verknr. 07-011 Dags. Ágúst 2007 Teiknir. A-101 Útgáfa A

5804

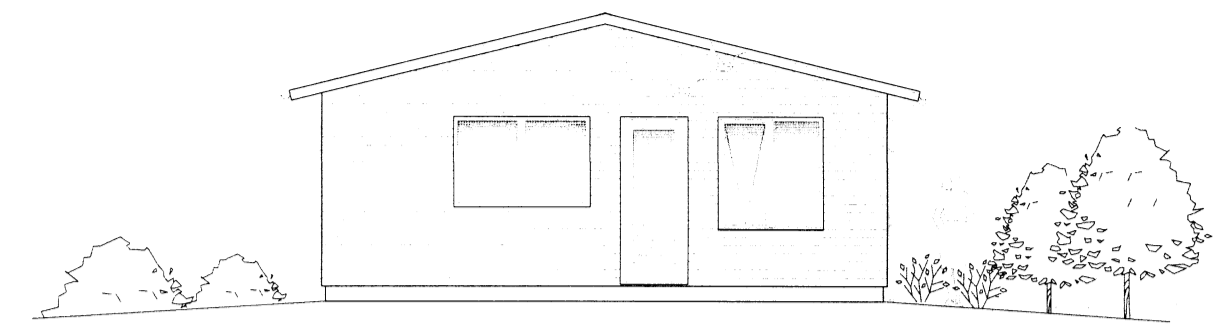

Suðlæg hlið
 Mkv. 1:100

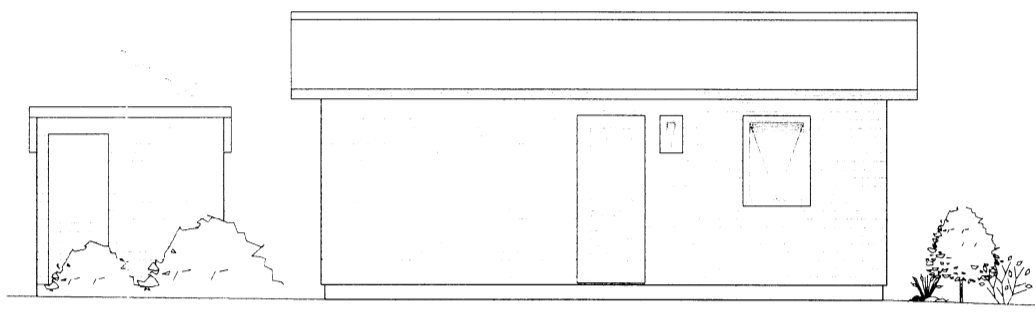

Vestlæg hlið
 Mkv. 1:100

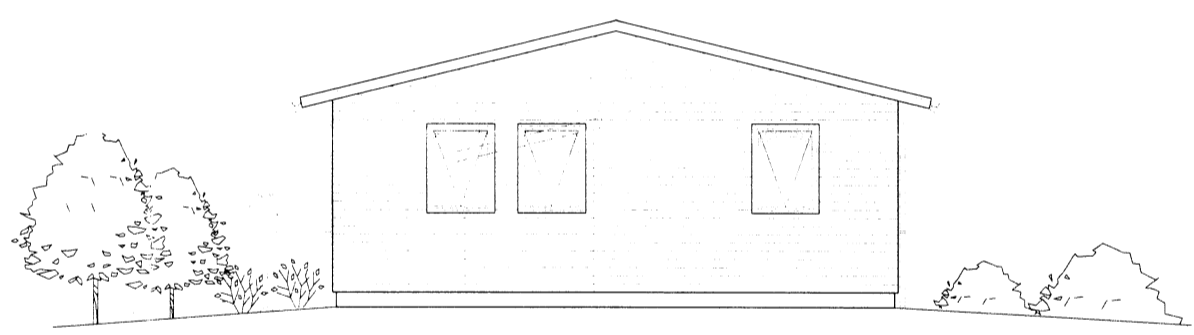

Norðlæg hlið
 Mkv. 1:100

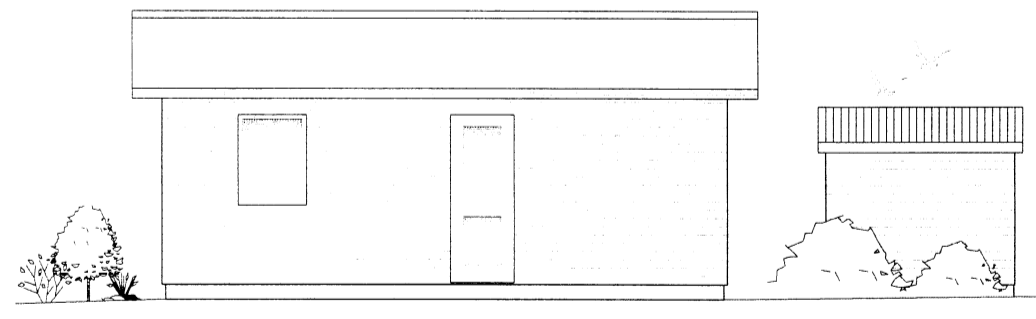

Austlæg hlið
 Mkv. 1:100

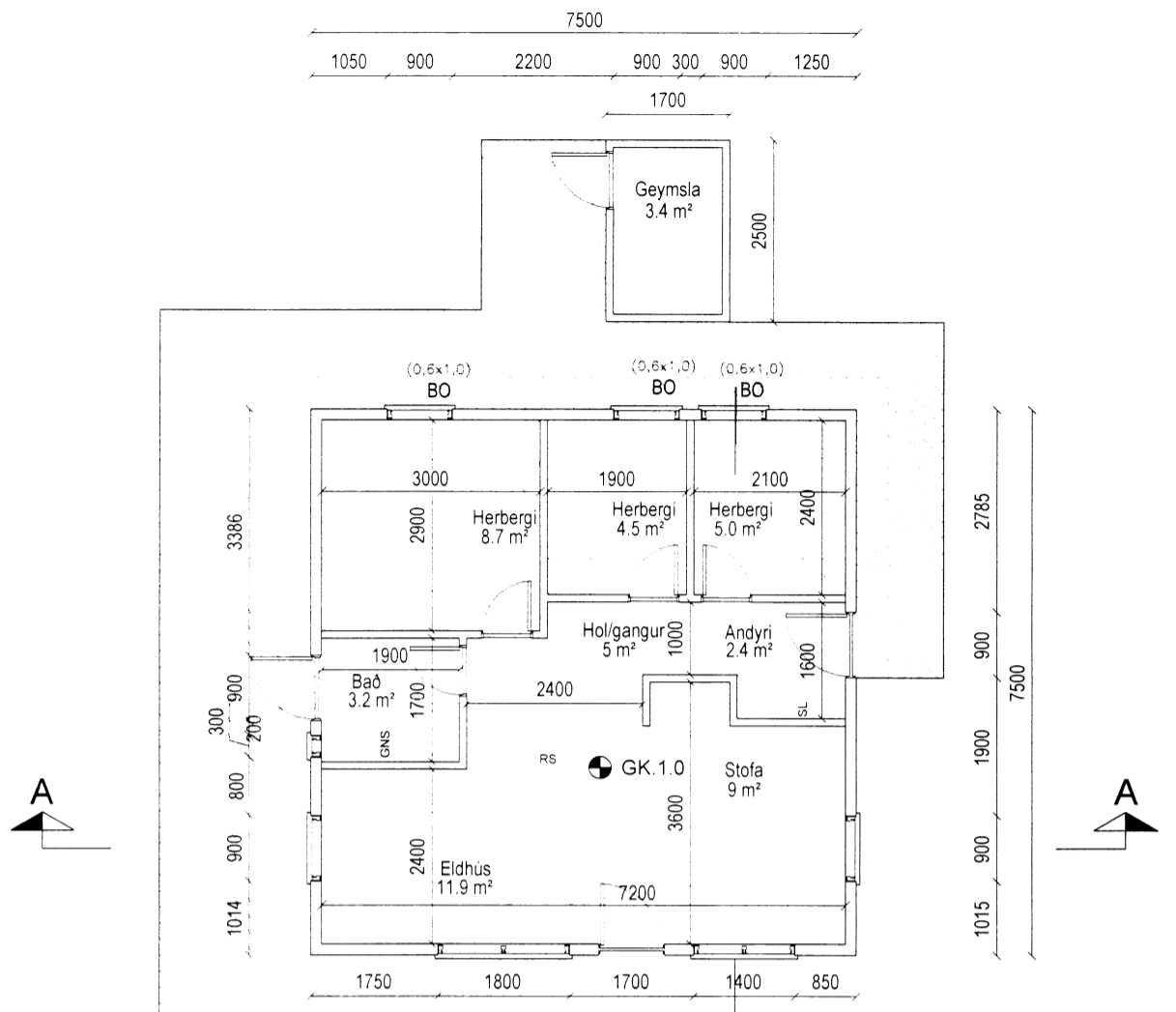

Grunnmynd
 Mkv. 1:100

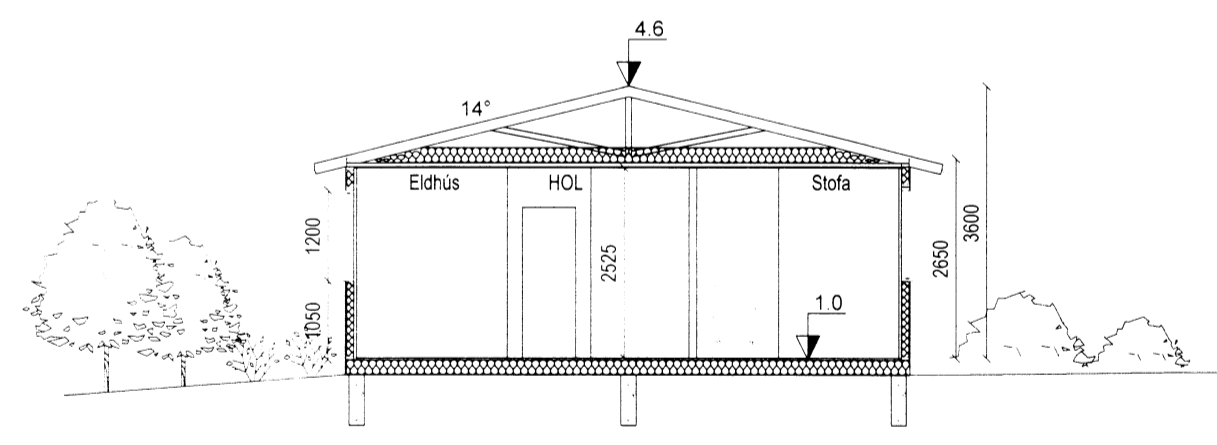

Snið A-A
 Mkv. 1:100

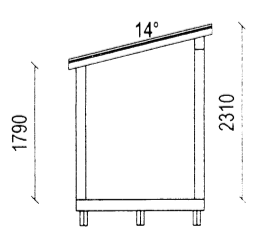

Snið í Geymslu
 Mkv. 1:100

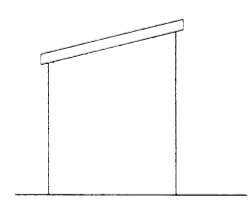

Norðlæg hlið
 Mkv. 1:100