

Samþykkt  
 11. SEP 2007  
*Alma Einars*  
 Byggingarstjórnun og hönnun

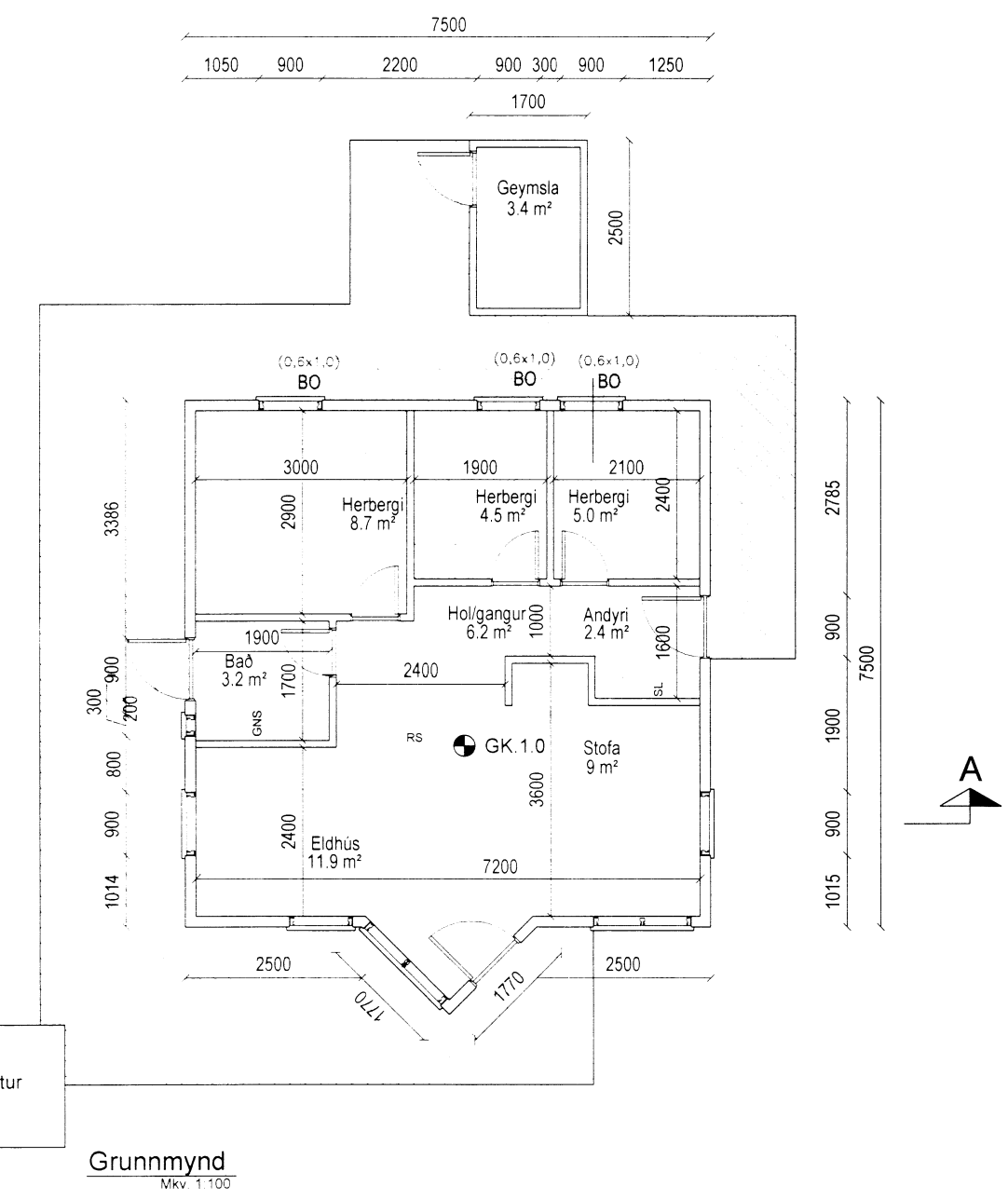

Grunnmynd  
Mkv. 1:100

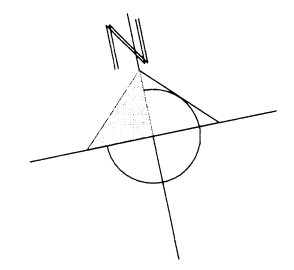
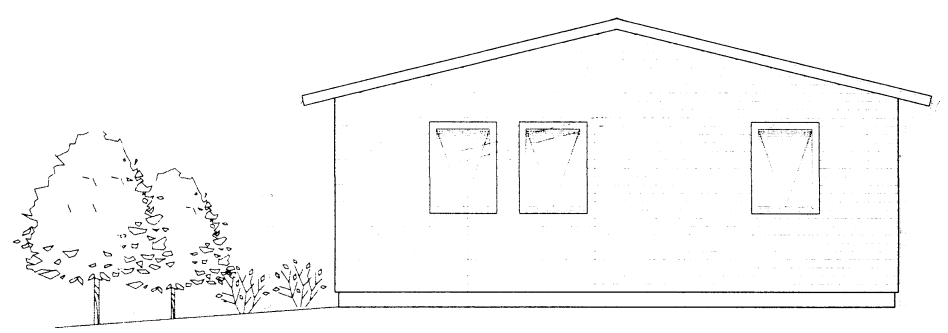

Norðlæg hlíð  
Mkv. 1:100

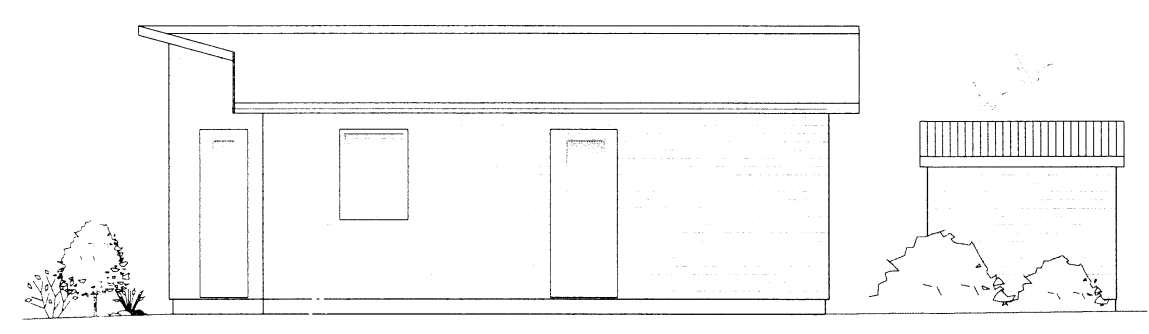

Austlæg hlíð  
Mkv. 1:100

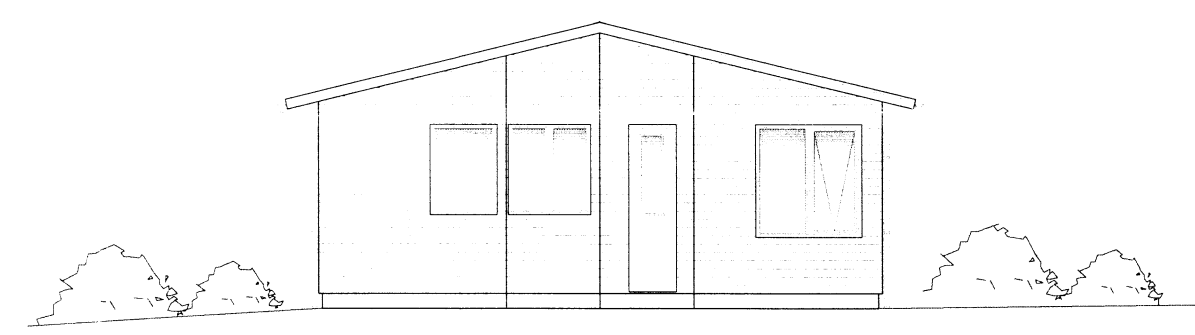

Suðlæg hlíð  
Mkv. 1:100

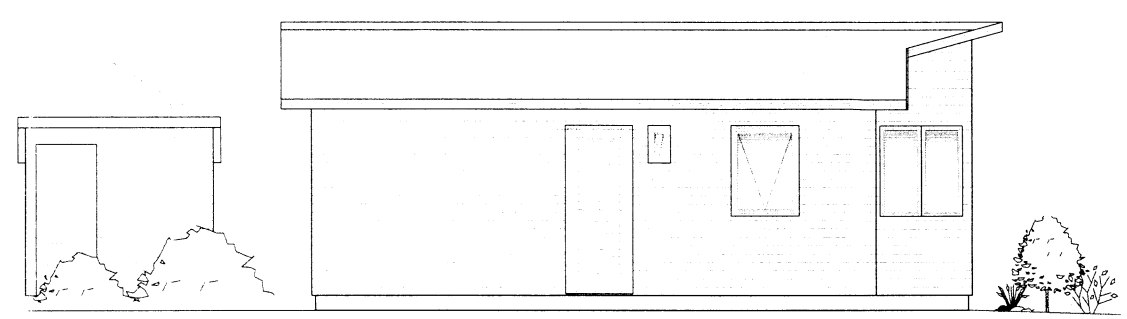

Vestlæg hlíð  
Mkv. 1:100

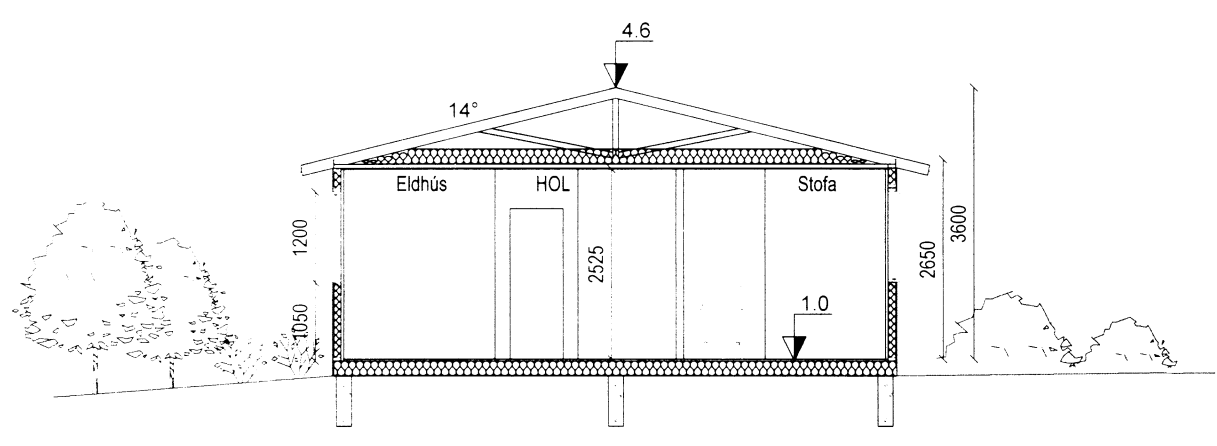

Snið A-A  
Mkv. 1:100

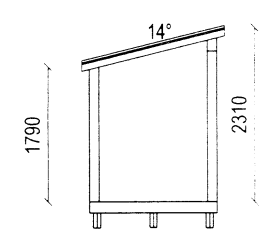

Snið í Geymslu  
Mkv. 1:100

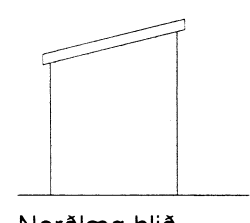

Norðlæg hlíð  
Mkv. 1:100

- SKÝRINGAR:
- SL. SLOKKVITÆKI
  - RS. REYKSKYNIARI
  - BO. BJÖRGUNAROP
  - GNF. GEGNUMSTREYMISNIÐURFALL
  - NF. NIÐURFALL
  - LR. LOFTRÆSTING
  - HÆDARKÓTAR Á GRUNNMYND
  - 27.56 HÆDARKÓTAR Á SNIDI
  - 0101 NOTEININGANÚMER

**Pro-Ark teiknistofa**  
 Austurvegi 69, 800 Selfoss Sími 482 4430 Fax 482 4435 proark@proark.is

hönnun skipulag áætlanir eignaumsjón

Eiríkur Vignir Pálsson BFI Kt:010975-4179  
 Kjartan Sigurbjartsson BFI Kt:190275-5319

Verk. **Holtabyggð 10.**  
**Sumahús mhl 11 & 12**

Teikn. **Grunnmynd og sniðteikning**

Hann. EVP / K.Sig Teiknad. K.Sig Mkv. 1:100

Verknr. 07-011 Dags. Ágúst 2007 Teikninnr. **A-101** Útgáfa **A**

5805