

## ALMENNT

HÆÐIR ERU Í HÆÐARKERFI REYKJAVÍKUR

24.00

TÁKNAR HÆÐ: 24.00 m Í SNIDMYND.

24.00

TÁKNAR HÆÐ: 24.00 m Í GRUNNMYND.

JÄRNASTÆRÐIR ERU Í mm.

TIMBURÞVERMÁL ERU Í mm.

ÖLL ÖNNUR ÖNEFND MÁL ERU Í cm.

180

MERKIR: ÞYKKT PLÖTU (VEGGJAR) ER 180 MM.

Á GRUNNMYND AF PLÖTU ER SNIDID TEKID UNDIR

ÞEIRRI PLÖTU SEM ER SÝND.

TÁKNAR STEYPUSKIL. Í LÖÐRÉTTUM STEYPUSKILUM  
VEGGJA KOMI A.M.K. 100 mm PLASTÞÉTTILISTI.

MERKING SÚLNA, SNIDA OG SÉRMYNDA:

Ab EÐA S1b. TALAN (b) MERKIR BLAÐNÚMER

ÞAR SEM SNID EÐA SÉRMYND ER SÝND.

## STEINSTEYPA

BROTÞOLSFLOKKAR STEYPU

BYGGINGARHLUTAR	BROTÞOLS FLOKKUR	FRAMKVÆMDA FLOKKUR
SÖKKLAR OG BOTNPLATA	C25	B
SJÁLFBERANDI PLÖTUR	C25 *	B
ÚTVEGGIR OG INNVEGGIR	C25	B

ATH. ÞÉTT Fylliefni

\*) FJADURSTUÐULL (E-GILDI) STEYPU Í SJÁLFBERANDI PLÖTUM SKAL VERA A.M.K 30.000 MPa NEMA ANNAD SÉ SÉRSTAKLEGA TEKID FRAM Á GRUNNMYND. ÞETTA ÞÝÐIR AÐ Fylliefni Í STEYPU MEGA EKKI VERA ÁBERANDI OPIN. Í PLÖTUR INNANHÚS MÁ NOTA C25 EF FJADURSTUÐULL UPPFyllir OFANGREIND SKILYRÐI

## STEYPA ALMENNT

ALLA STEYPU SKAL TITRA. SIGMÁL SKAL VERA 6-8 cm. LOFTINNIHALD SKAL ALMENNT VERA 5-7%, MÆLT RÉTT FYRIR NIÐURLÖGN. HEIMILT ER ÞÓ AÐ LÆKKA LOFT Í INNISTEYPU NIÐUR Í ALLT AÐ 4 % VATNSSEMENTSTALAN V/S < 0.55  
D<sub>max</sub> = 32 mm, NEMA ANNAD SÉ TEKID FRAM Á TEIKNINGUM EÐA Í VERKLÝSINGU. EF SÉRVIRK ÞJÁLNIEFNI ERU NOTUÐ, SKAL BLANDA LOFTBLENDI Í Á UNÐAN OG HRÆRA Í A.M.K. 2 1/2 MÍN. ÁÐUR EN ÞJÁLNIEFNUNUM ER BLANDAÐ SAMAN VIÐ. Í ÚTVEGGJASTEYPU SKAL SEMENTSMAGN VERA A.M.K. 300 KG/M3 OG V/S < 0.55. Í ÚTVEGGJUM SEM VERÐA FYRIR MIKILLI VEÐRUN OG VERULEGUM SALTÁHRIFUM, SKAL SEMENTSMAGNÐ VERA A.M.K. 350 kg/m3 OG V/S < 0.45. UM ÖLL ÖNNUR ATRÍÐI STEYPUVINNU GILDIR ÍST 10.

## ÁLAGSFORSENDUR / STAÐLAR

ÖRYGGISKERFI:	SKV. ÍST DS 409
STEYPUVIRKI:	SKV. ÍST DS 411
STÁLVIKRI:	SKV. ÍST DS 412
TIMBURVIKRI:	SKV. ÍST DS 413
ÁLAG Á GRUNN:	SKV. ÍST DS 415
NOTÁLAG, VINDÁLAG OG SNJÓÁLAG:	SKV. ÍST DS 410
JARÐSKJÁLFTAÁLAG:	SKV. EC 8

Grunngildi snjóálags er Sk = 2.1 KN/m2

Grunngildi vindálags (karakterístísk) er Q<sub>max</sub> = 1.6 KN/m2

Notálag: Innan íbúðar 2,0 KN/m2

Á svölum 3,0 KN/m2

## JÄRNALÖGN

UM BENDISTÁL OG JÄRNAVINNU ALMENNT GILDIR ÍST 10 NEMA ANNARS SÉ GETID Á TEIKNINGUM EÐA Í VERKLÝSINGU.

GERÐ OG MERKING JÄRNA.

ALMENNT SKAL BENDISTÁL FULLNÆGJA KRÖFUM DS 13080.

K: MERKIR KAMBSTÁL K<sub>s</sub>500 MEÐ SKRÍÐMÖRK fyk > 500 MPa,

MÍÐAÐ VIÐ 0.1 % VÍKMÖRK.

C: MERKIR MILLIBIL MILLI JÄRNA Í MM.

BENDINET SKAL FULLNÆGJA KRÖFUM DS 13082.

K131: MERKIR BENDINET MEÐ SKRÍÐMÖRK fyk > 500 MPa, MÍÐAÐ VIÐ 0.1 % VÍKMÖRK OG ÞVERSNIÐSFLATARMÁL = 131 mm<sup>2</sup>/m.

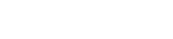
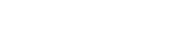
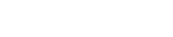
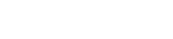
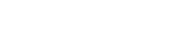
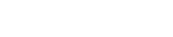
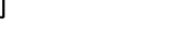
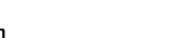
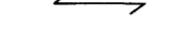
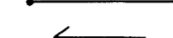
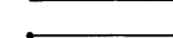
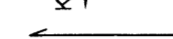
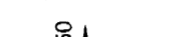
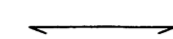
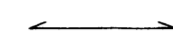

JÄRN Í NEDRI BRÚN PLÖTU / YTRI BRÚN VEGGJAR.  
JÄRN Í EFRI BRÚN PLÖTU / INNRI BRÚN VEGGJAR.

10 mm KAMBSTÁL, með 250 mm MILLIBIL.

JÄRN ENÐAR, BEINN ENDI.

JÄRN BEYGIST SKEYTILENGD INN Í AÐLIGGJANDI BYGGINGARHLUTA.

AÐALBURÐARSTEFNA, STEFNA ÞEIRRA JÄRNA SEM LIGGJA NÆST YFIRBORDI PLÖTU.

MERKIR AÐ BIL MILLI JÄRNA SÉ JAFNT Í BÁÐAR ÁTTIR.

MERKIR UPPBEYGJULÍNU, ÞAR SEM ANNAD HVERT JÄRN BEYGIST UPP Í EFRI BRÚN Á PLÖTU.

## TENING JÄRNAGRINDA

d ER ÞVERMÁL JÄRNA.

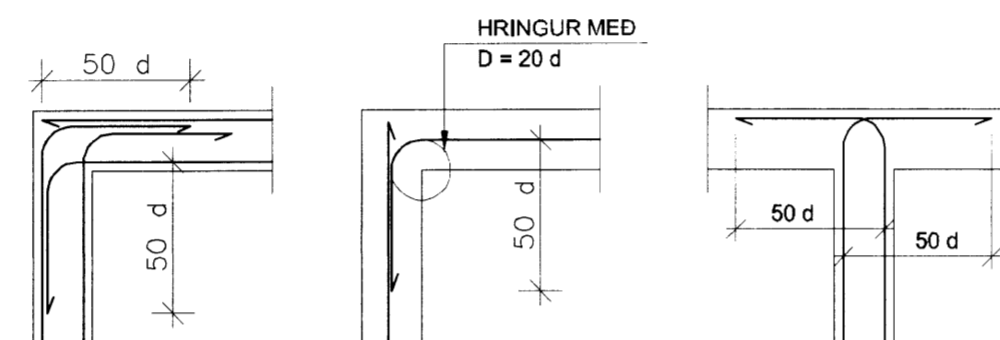

## BIL MILLI JÄRNA / STEYPUHULA

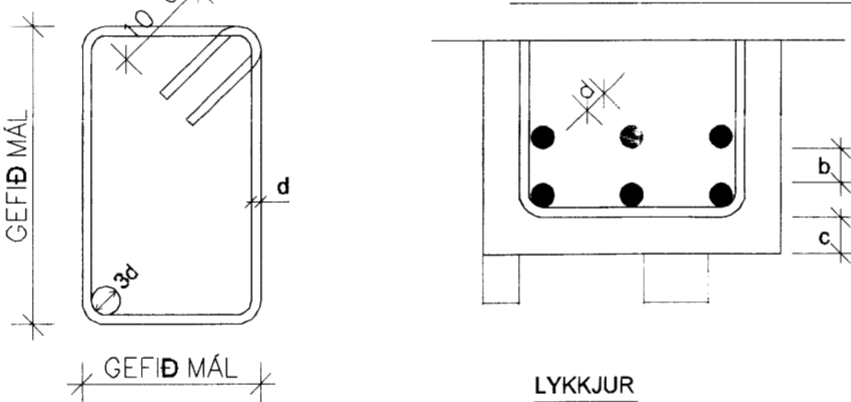

## LYKKJUR

Í LYKKJUR SKAL NOTA R-STÁL EÐA K<sub>s</sub>-STÁL (SUDUHÆFT KAMBSTÁL)

## SKEYTILENGD JÄRNA

SÉ ANNAD EKKI TEKID FRAM SKULU JÄRN ÆTÍÐ FEST SKEYTILENGD INN Í AÐLIGGJANDI BYGGINGARHLUTA.

Í PLÖTUM OG VEGGJUM SKAL EKKI SKEYTA MEIRA EN FJÓRÐA HVERT

JÄRN Í SAMA ÞVERSNIÐI OG EKKI NEMA ÞRÍÐJA HVERT JÄRN Í BITUM

NEMA ANNAD SÉ SÝNT Á TEIKNINGUM. SKEYTILENGD VIÐ VÍXLLAGNINGU

KAMBSTÁLS SKAL VERA 40d (d = ÞVERMÁL STANGAR).

ÞVERMÁL STANGAR í mm	8	10	12	16	20	25
SKEYTILENGD í cm	32	40	48	64	80	100

SÉ EKKI ANNAD TEKID FRAM SKAL LEGGJA 2K12 Í KRINGUM GÖT, DYRA- OG GLUGGAOP ER NÁI 500 MM ÚT FYRIR OPID.

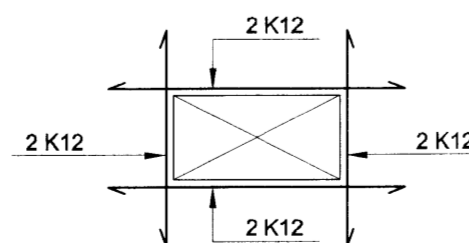

## SKEYTING BENDINETA

ALMENNT GILDIR AÐ SKEYTILENGD NEMI ÞVÍ, AÐ ÞRJÚ ÞVERJÄRN SÉU Í VÍXLSKEYTUM, ÞÓ ALDREI MINNI EN 40d. BENDINET MEÐ 15 cm MÖSKVA SKAL ÞVÍ VÍXLEGGJA UM 2 MÖSKVA.

## VARÐANDI BIL MILLI JÄRNA / STEYPUHULU GILDIR:

a ≥ 2d  
D<sub>max</sub> + 10 mm

b ≥ 1.5d

ALMENNT GILDIR AÐ STEYPUHULAN (c), SKAL FULLNÆGJA EFTIRFARANDI KRÖFUM NEMA ANNAD SÉ TEKID FRAM Á TEIKNINGUM EÐA Í VERKLÝSINGU.

30 mm Í VEGGJUM UTANDYRA

c ≥ 15 mm Í LOFTPLÖTUM INNI

30 mm Í BITUM ÚTI

40 mm Í SÖKKLUM

## FYLLINGARPÚÐI

ÞJÖPPUNARKRÖFUR TIL FYLLINGAR UNDIR SÖKKLA ERU EFTIRFARANDI:

E2 ≥ 120 MPa OG E2/E1 ≤ 2.4

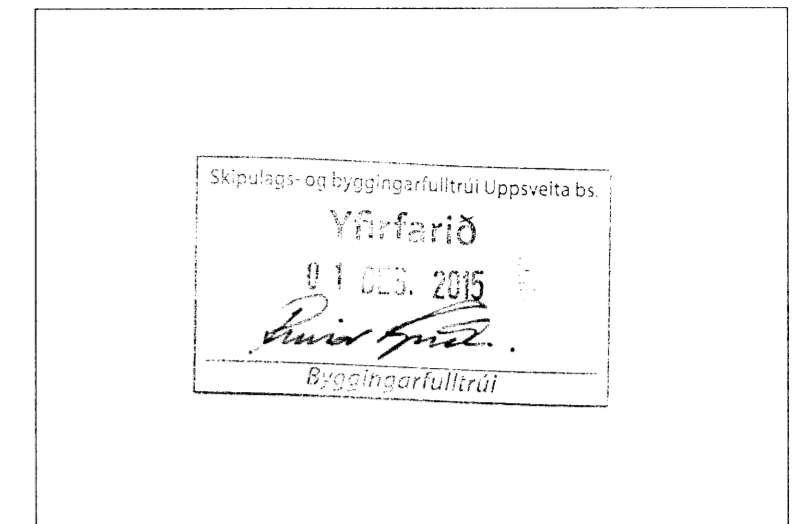

BREYTINGAR	DAGS:
UNDIRSKRIFT AÐALH.:	
VERKNÚMUR OG TEIKN.NR.:	<b>040815 B00</b>
HEITI UPPDRÁTTAR:	Burður almennar upplýsingar
DAGS:	04.09.2015
TEIKNAD AF:	BMS
MÁL:	1:50
VERK:	Kerhraun 22 GRÍMSNES-OG GRANNVÍKS HR.
<b>AV</b>	<i>[Signature]</i>
TEIKNISTOFA A.V.J.	AÐALSTEINN V JÚLIÚSSON Aubreyku 6, 200 Kópavogi. Símar 554-0673 & 690-0172 email: avj@simnet.is Kt.: 040344-3309

6669.