

SKÝRINGAR VIÐ UPPBYGGINGU Á ÚTVEGGJAGRINDUM

Útveggir hússins eru byggðir upp úr 45x148 mm timburstöðum með mesta millibili stöða m/m 600, allt burðarefni er styrkleikaflokkað í K18 a.m.k.

Allar samsetningar eru negldar með minnst 3 stk. S<sup>25</sup><sub>100</sub>.



*Handwritten signature*

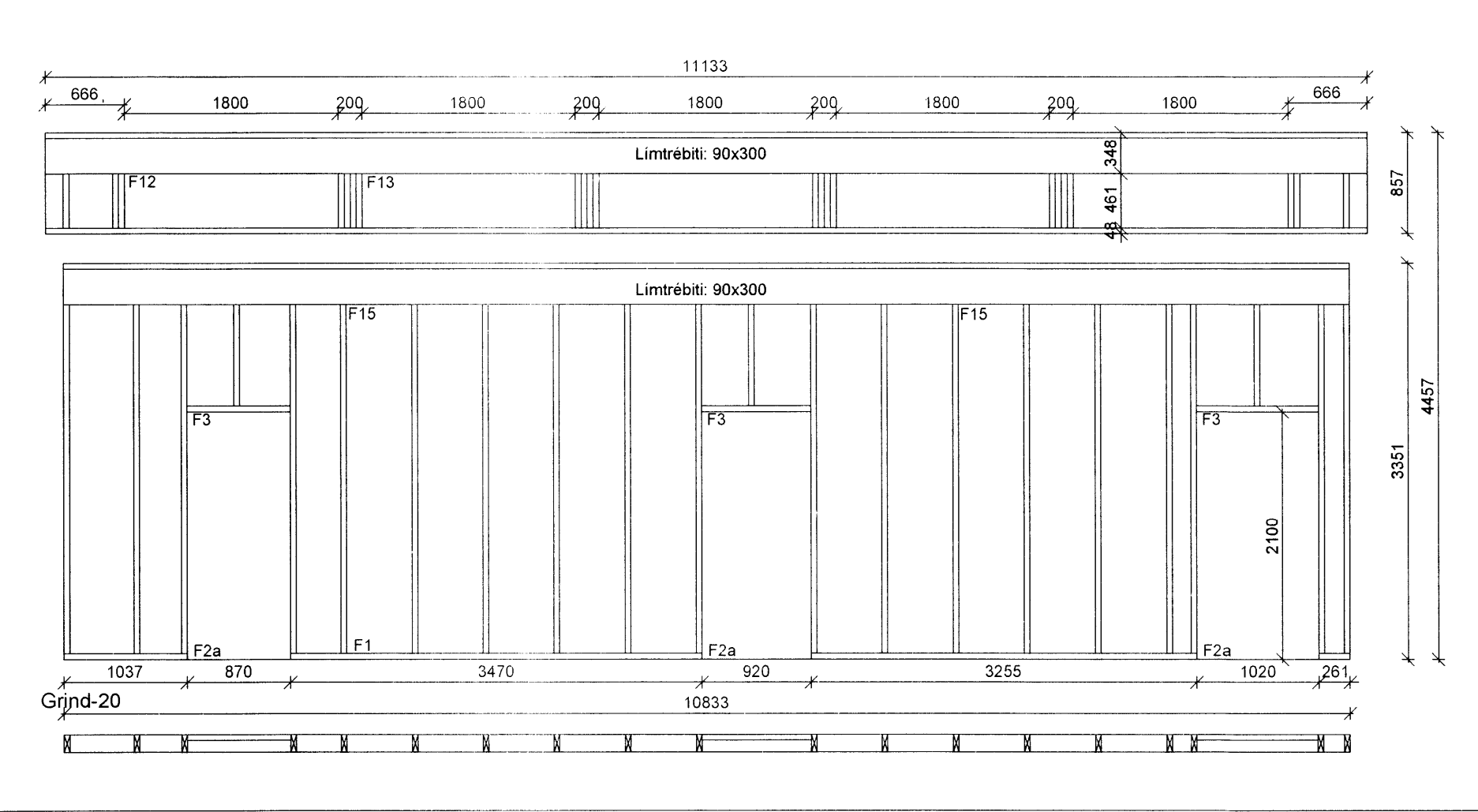
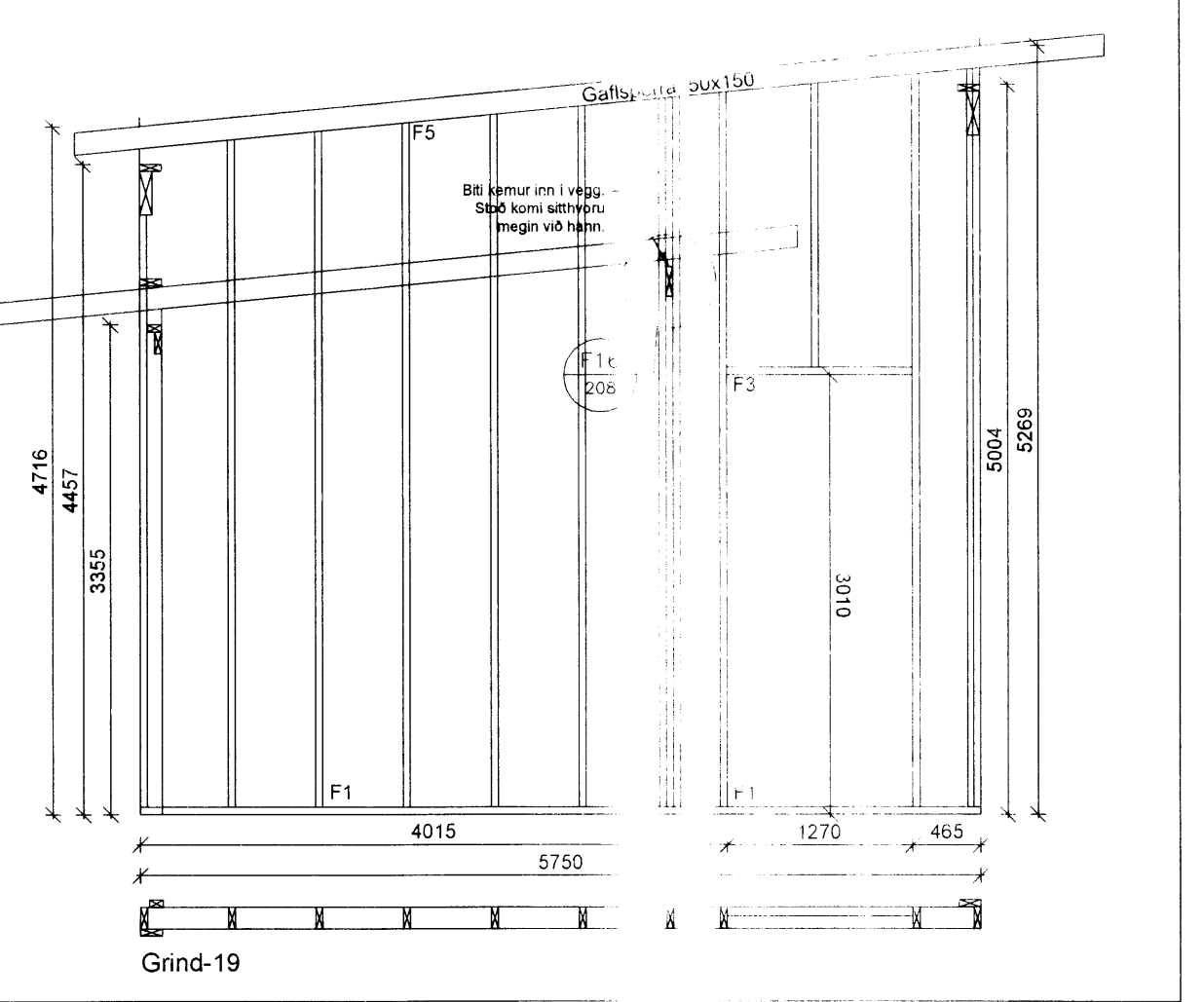
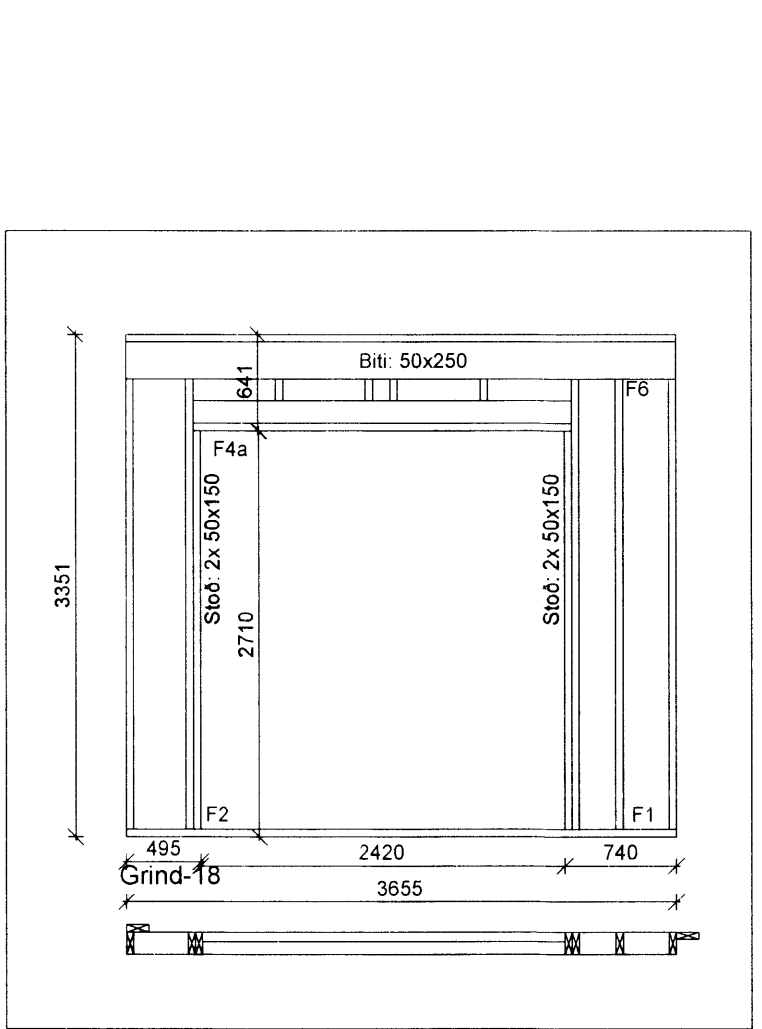
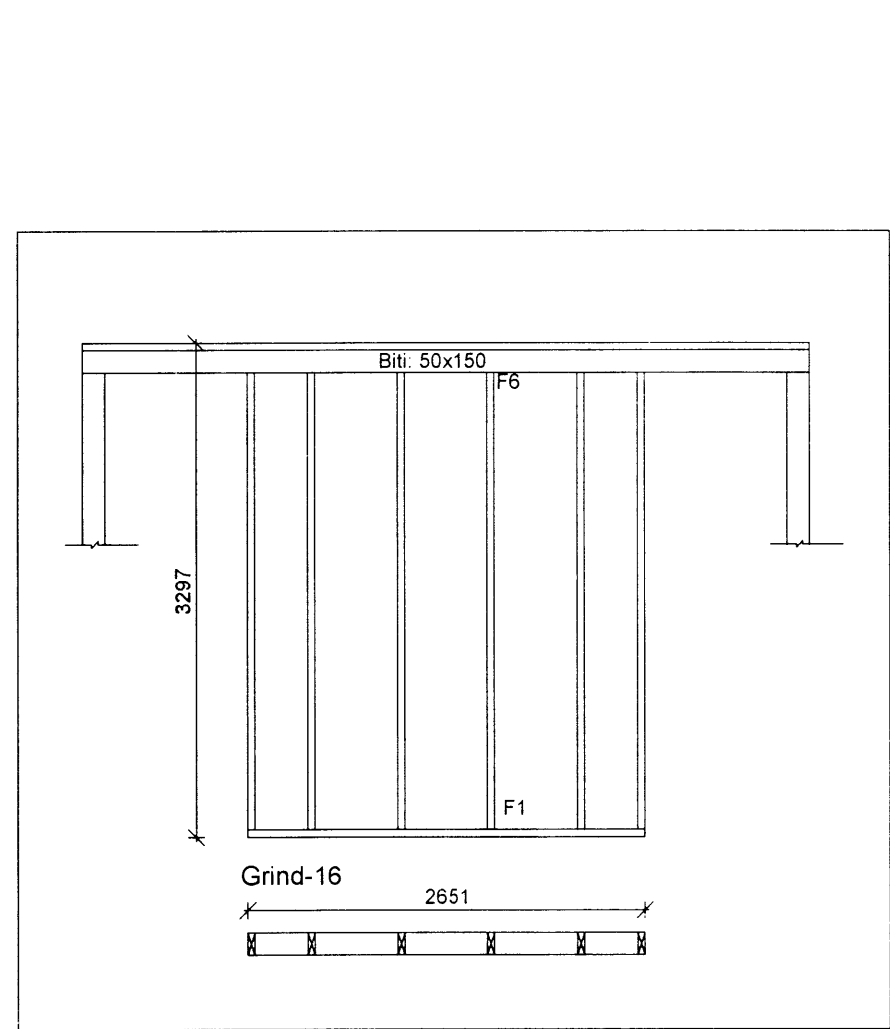
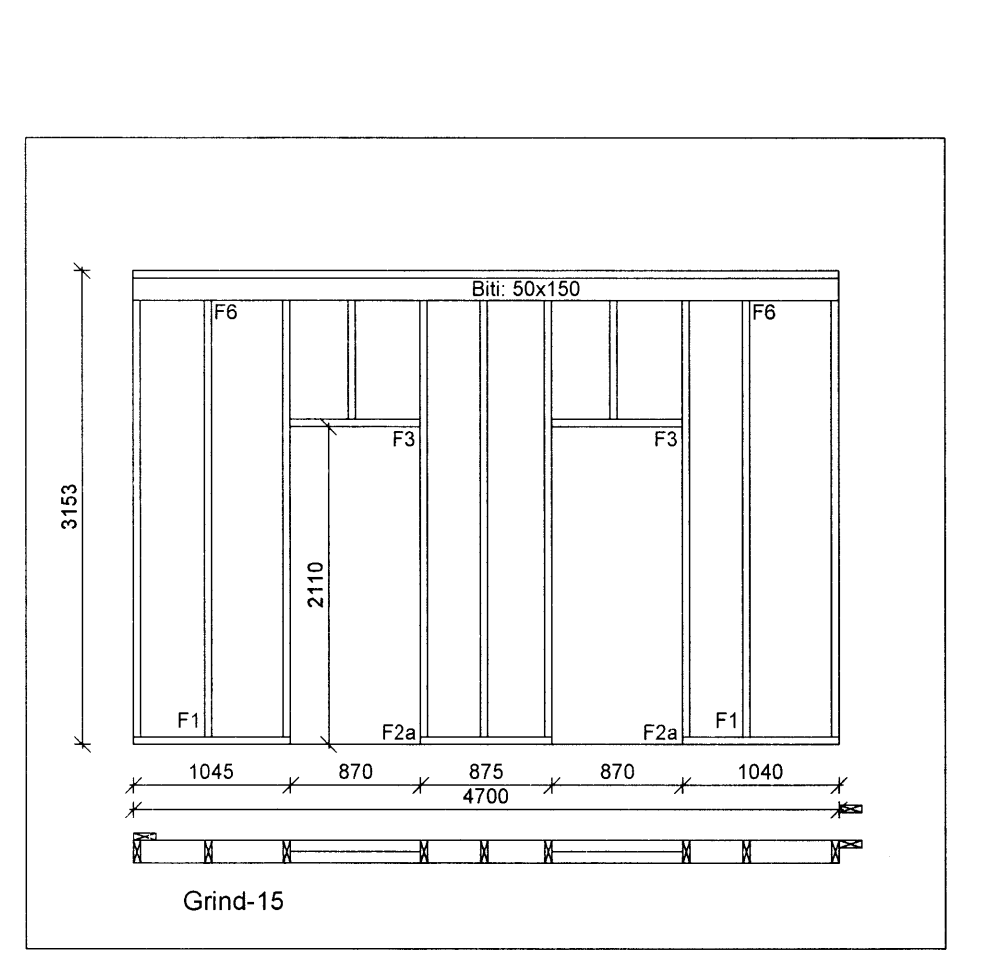
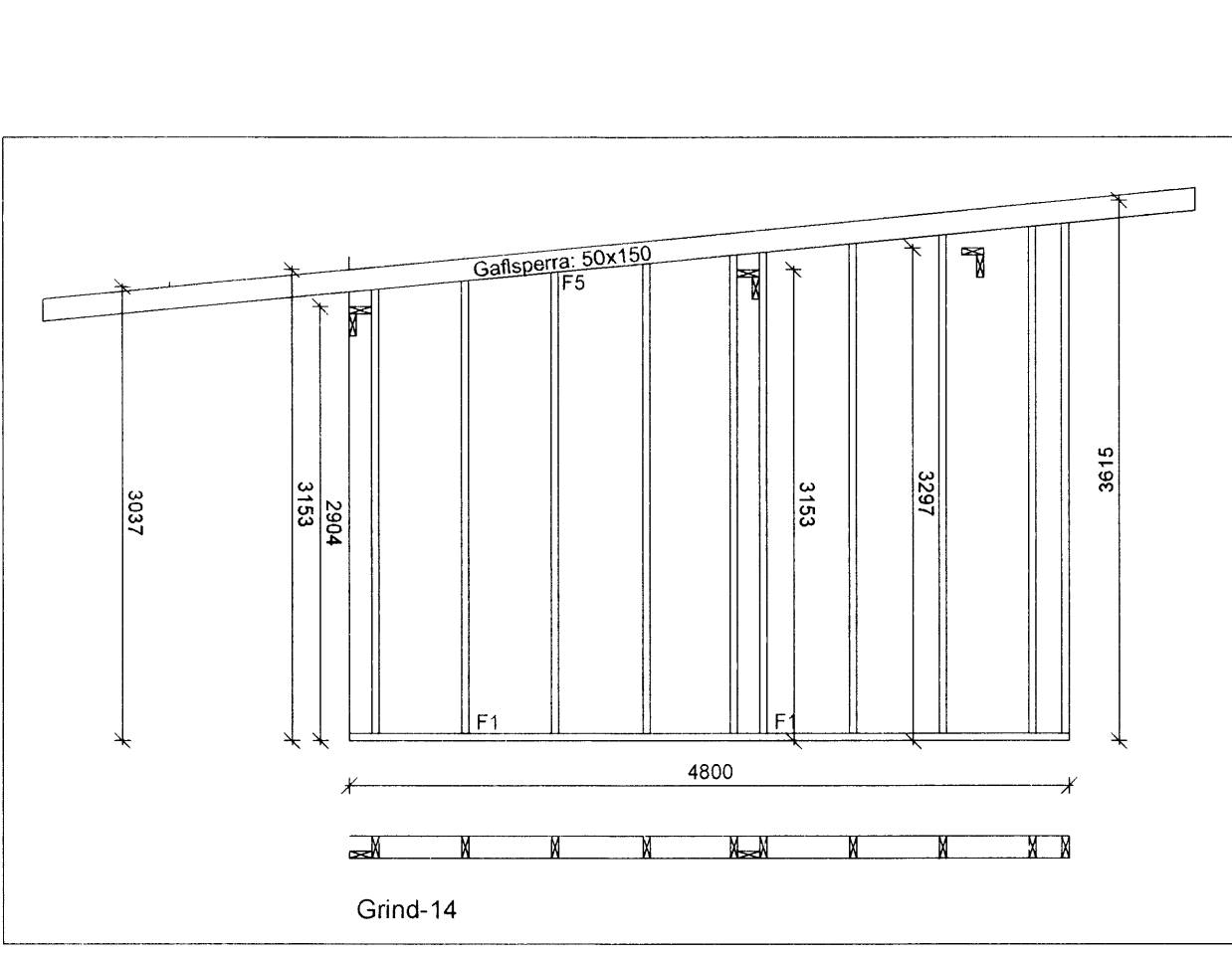
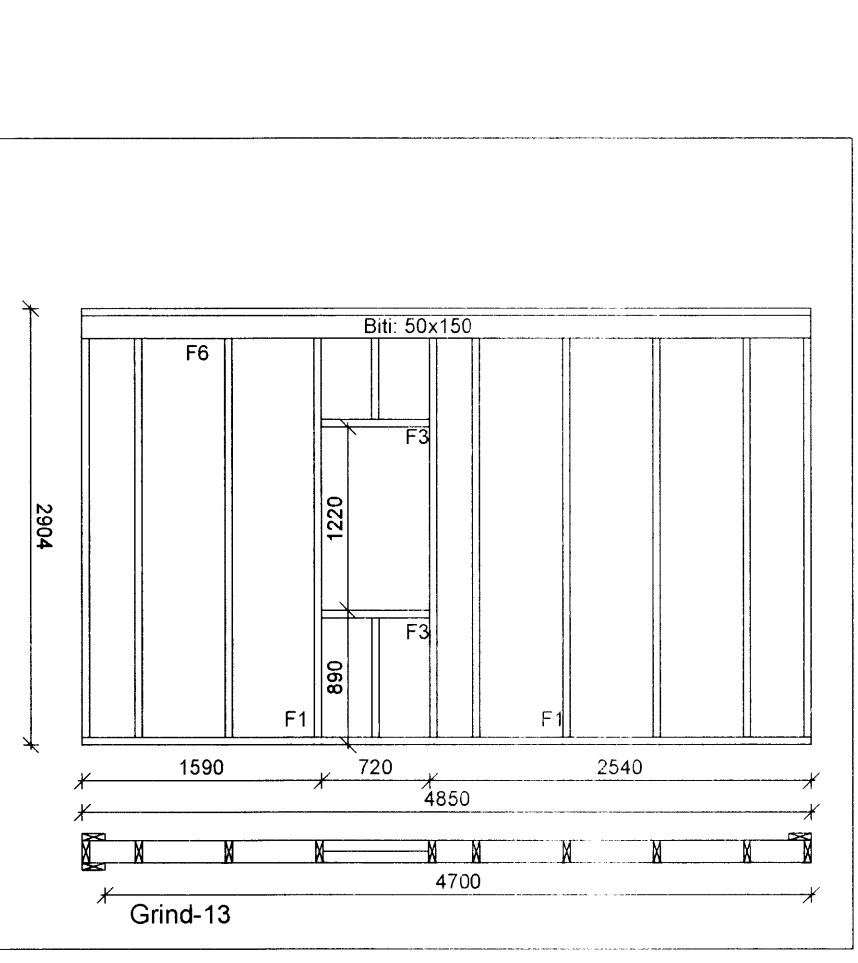
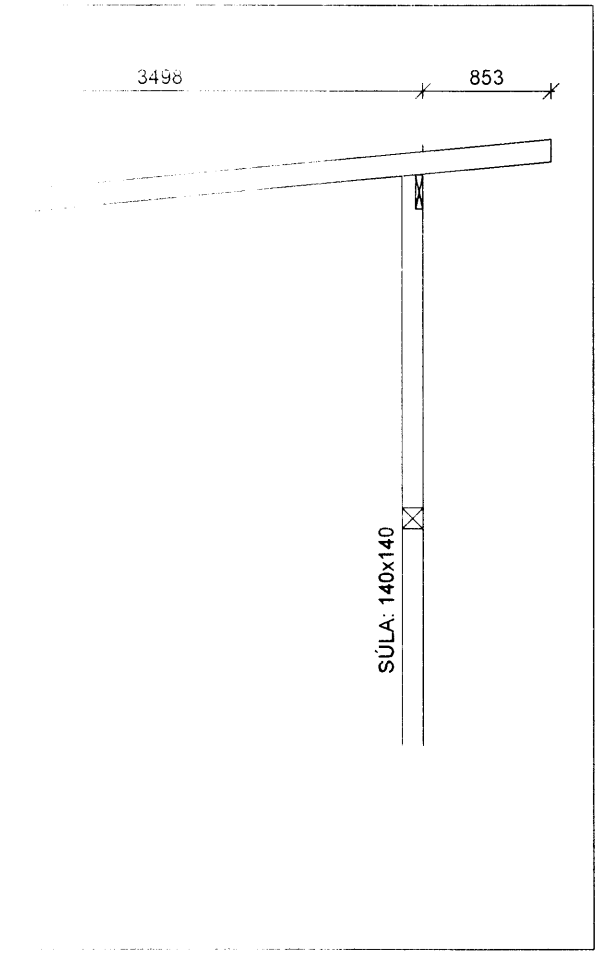
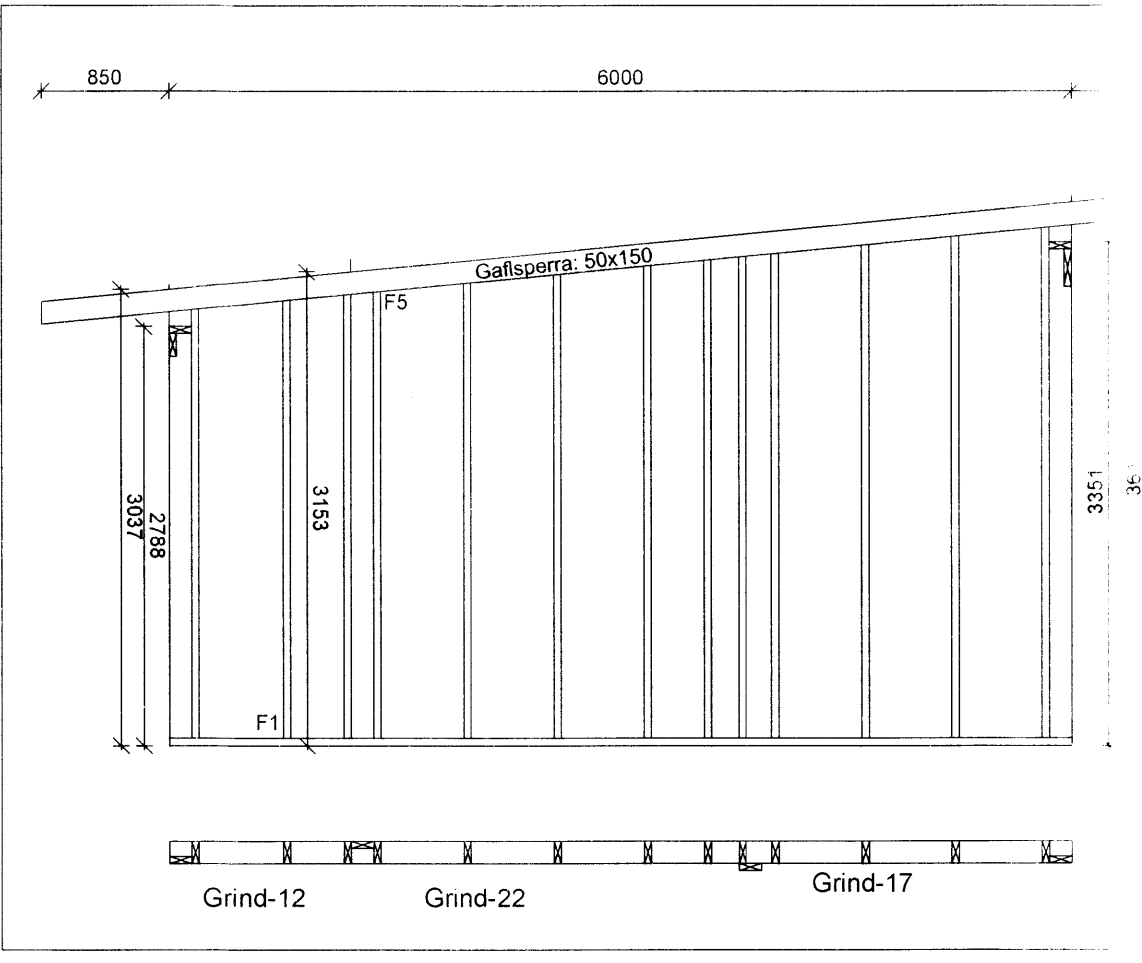
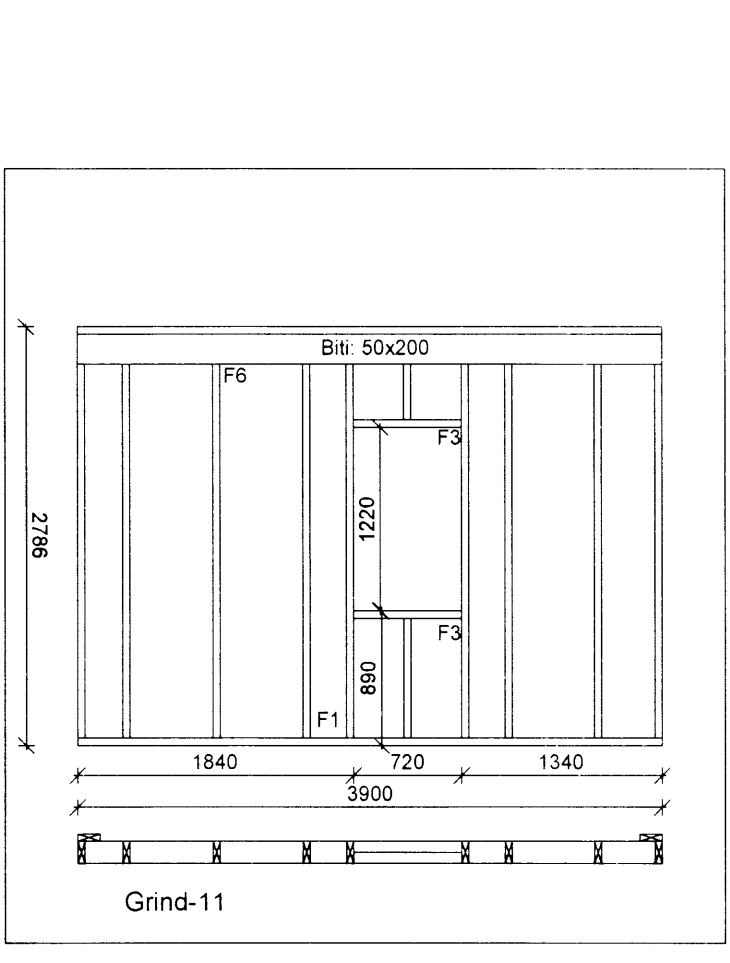
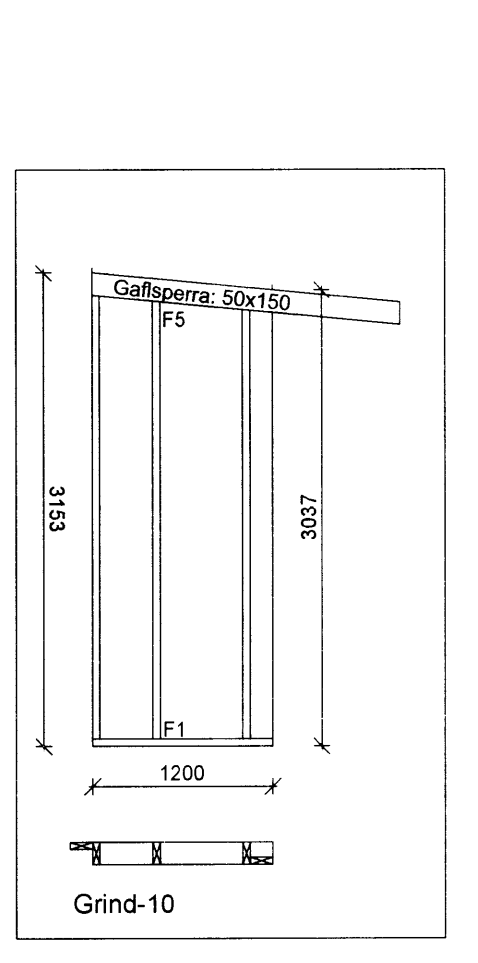
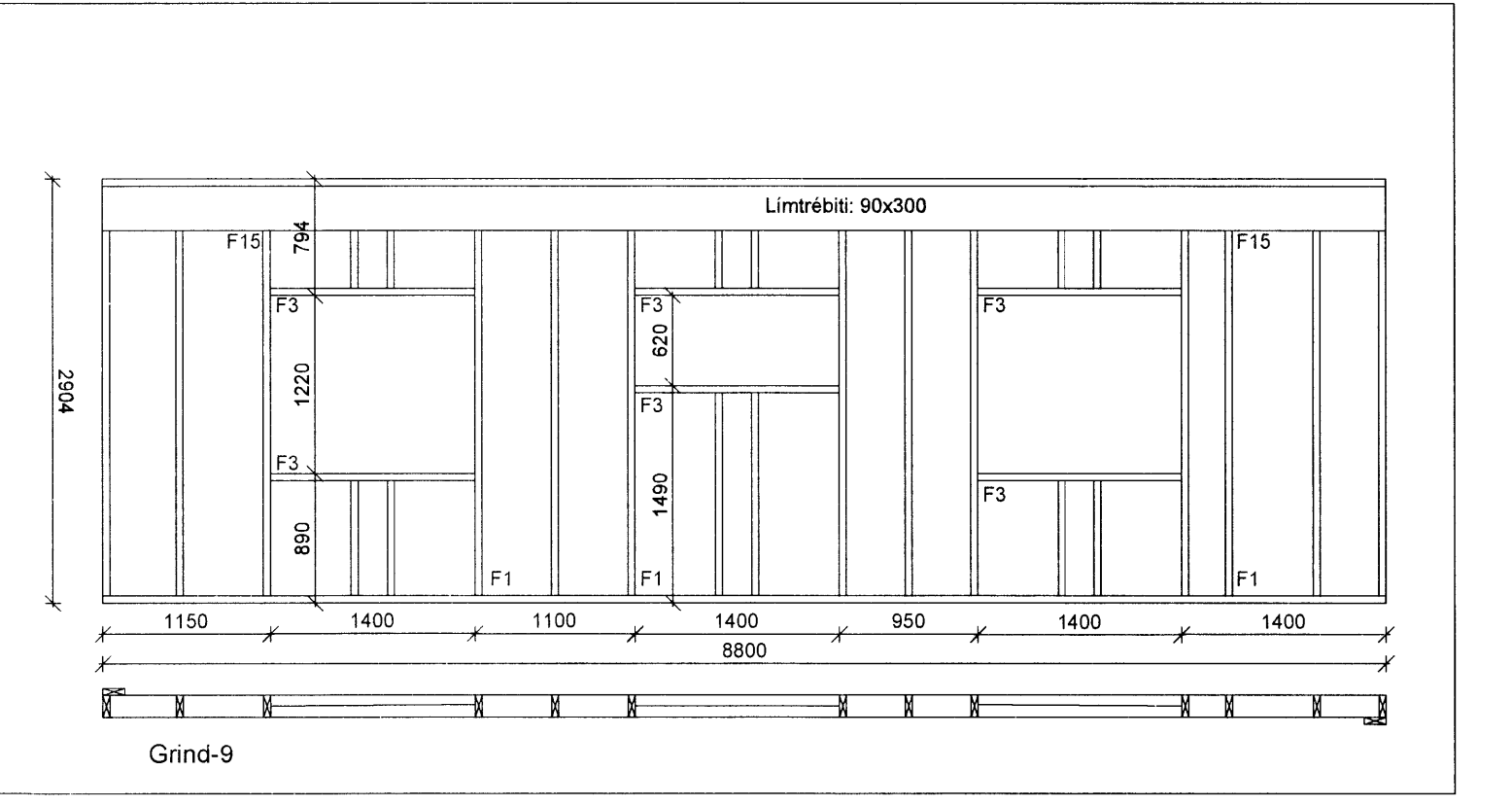
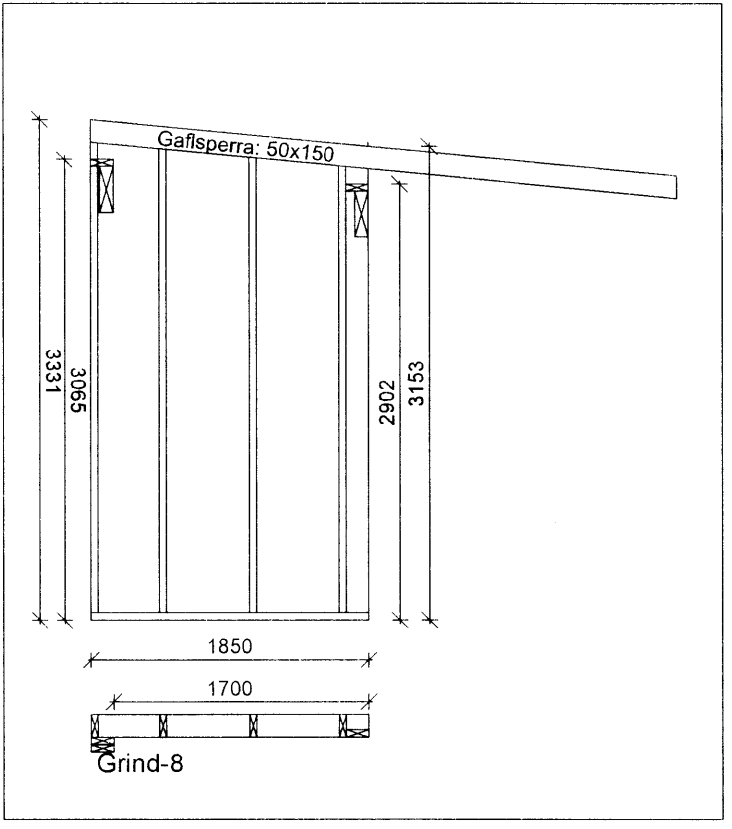
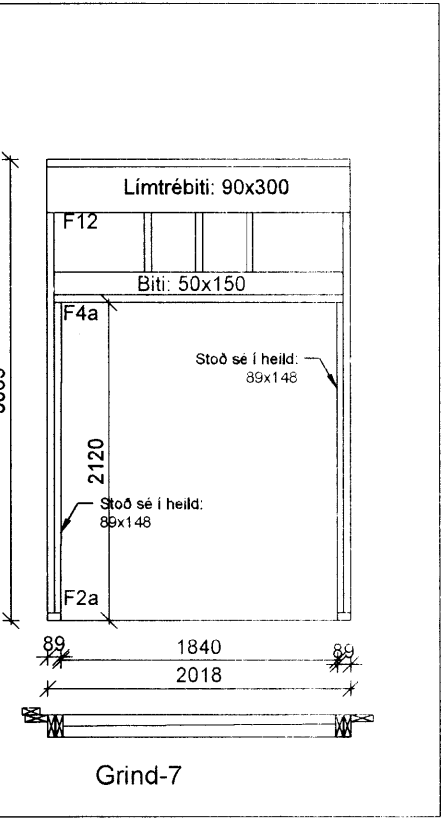
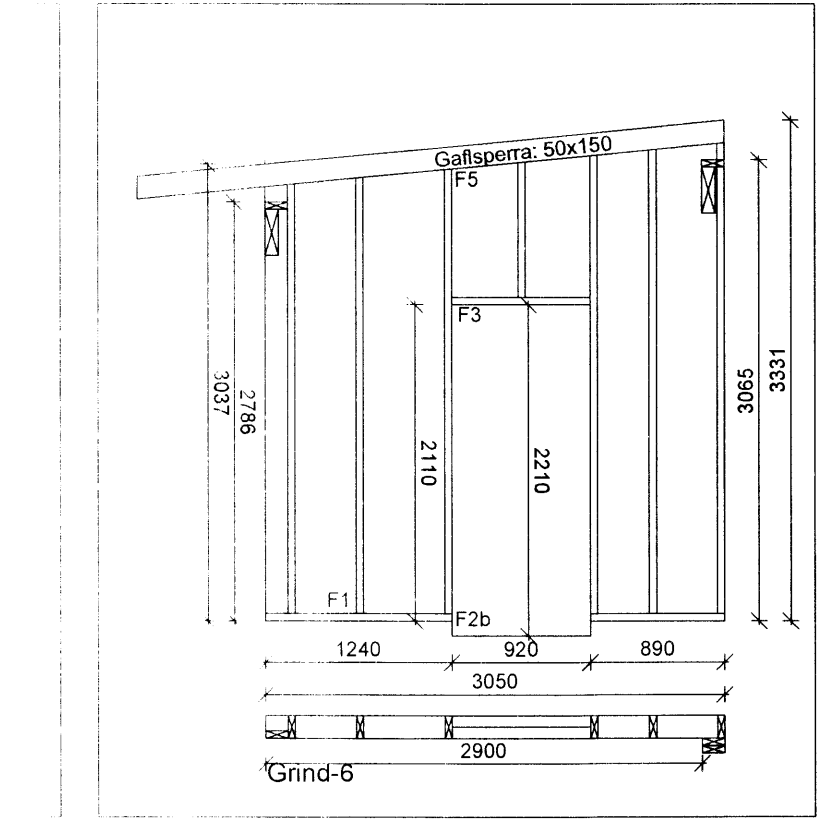
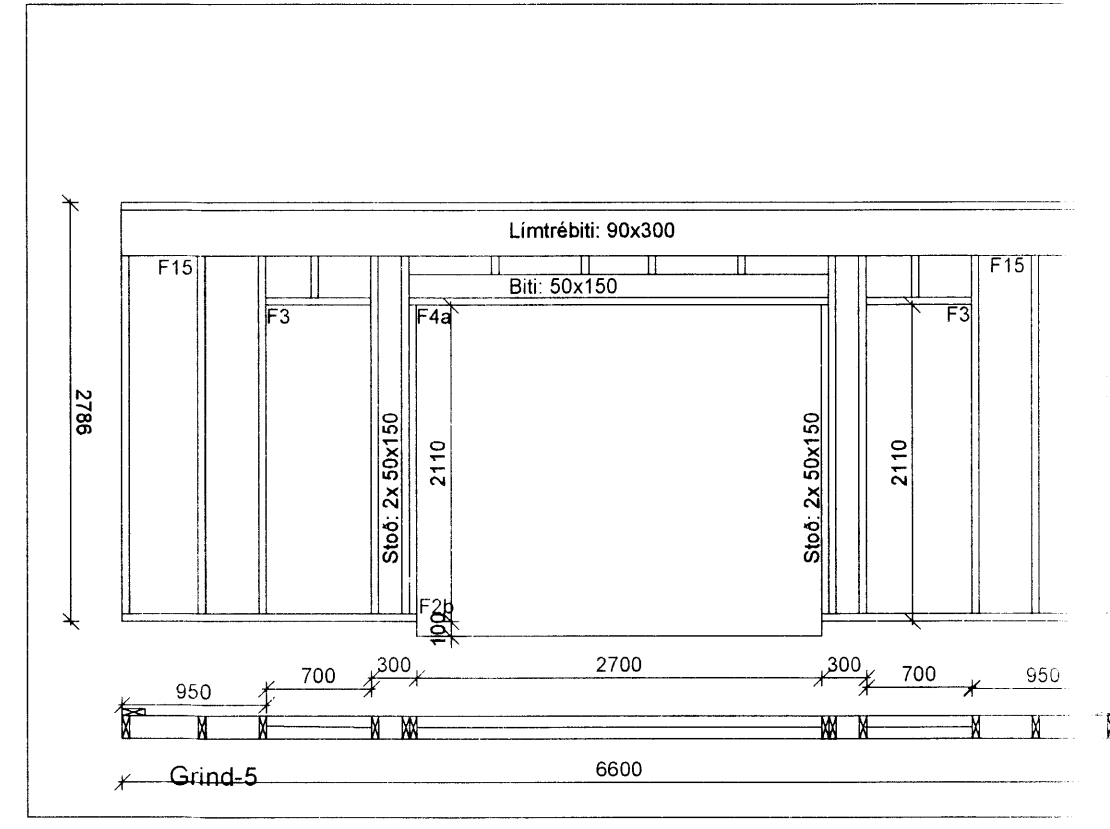
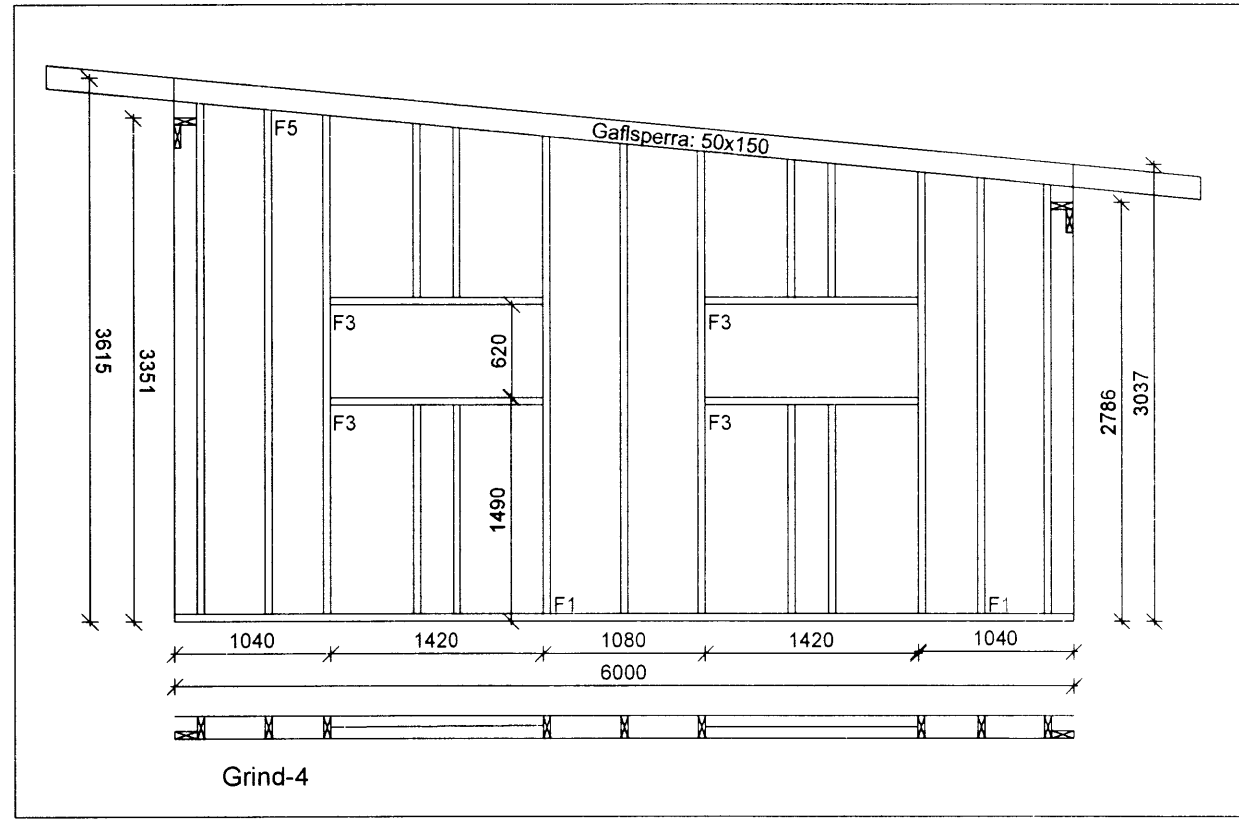

Breytingar:

**HÚSEY**  
Tæknir- og verkfræðisvæðing  
SELFOSSI

Vinnustofa: Stóru-Sandvík 4,  
801 Sandvík  
Sími 462-1738 / 666-9199  
Netfang: sams@simnet.is

Áb.m. og réttahétt: Samuel Smári Hreggviðsson,  
byggingateknifræðingur, M.T.F.I.  
Kt. 200752-4659

Vidfangsnefni: Kerhraun 12,  
Grimsnes- og Grafingshreppi

Verkhlefi: ÚTVEGGJAGRINDUR

Mælikvæði: 1:50  
Teknað/Reiknað: ssh

Dagsetning: Stóru-Sandvík 4, 1. janúar 2016

Sambýskt: 11. apríl 2016  
*Sam SA*

Verknúmer: 15-720

Tekn.nr.: 207

7936.