

MÓTTEKIÐ

13. JAN. 2009

Byggingafultrúi uppsv. Arnessýslu og Flóahf.

F1

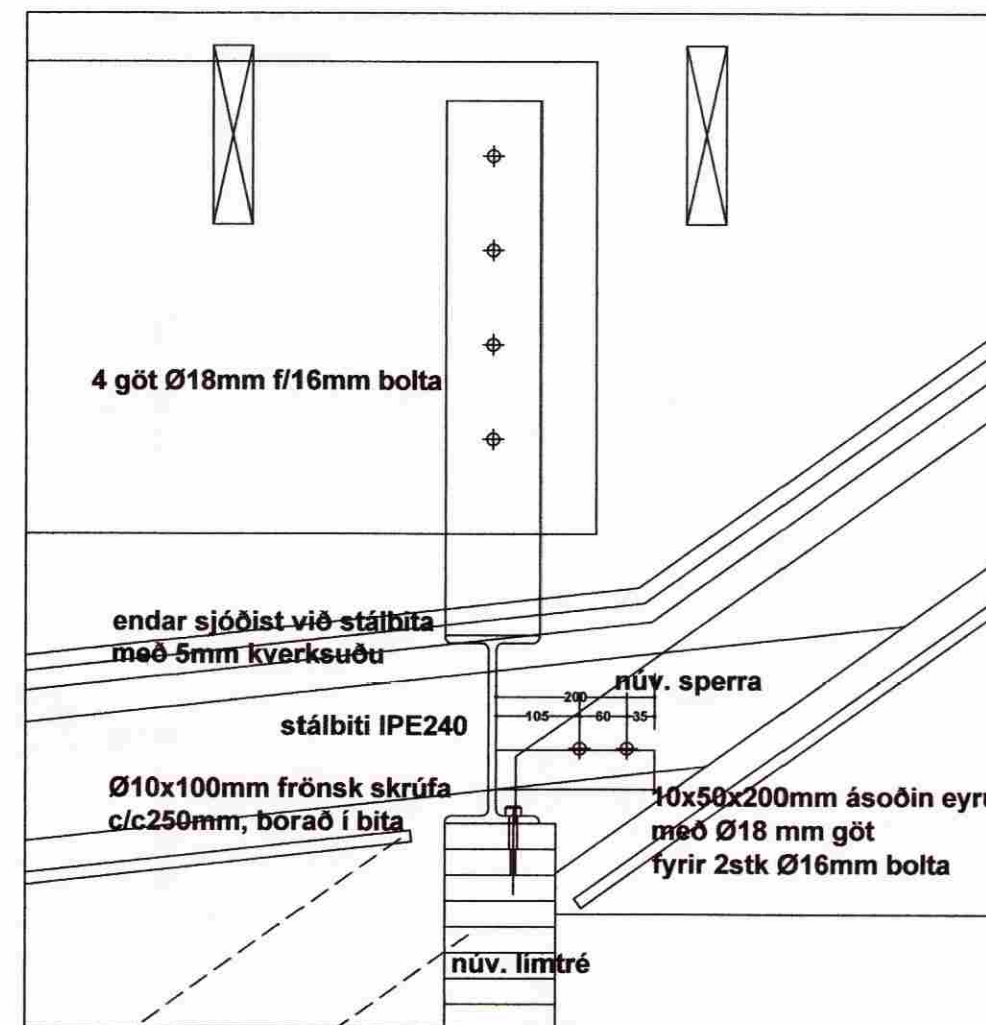
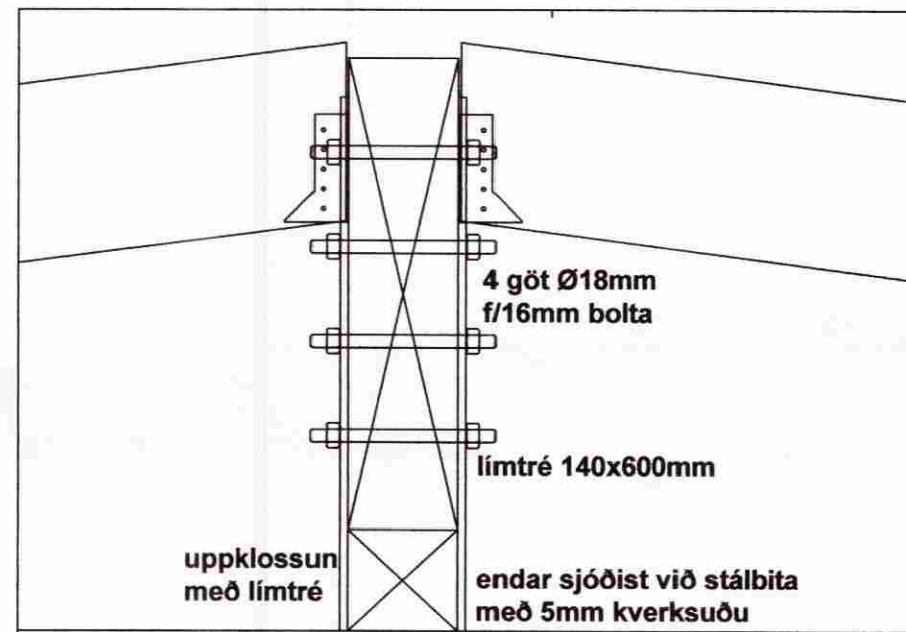

F2

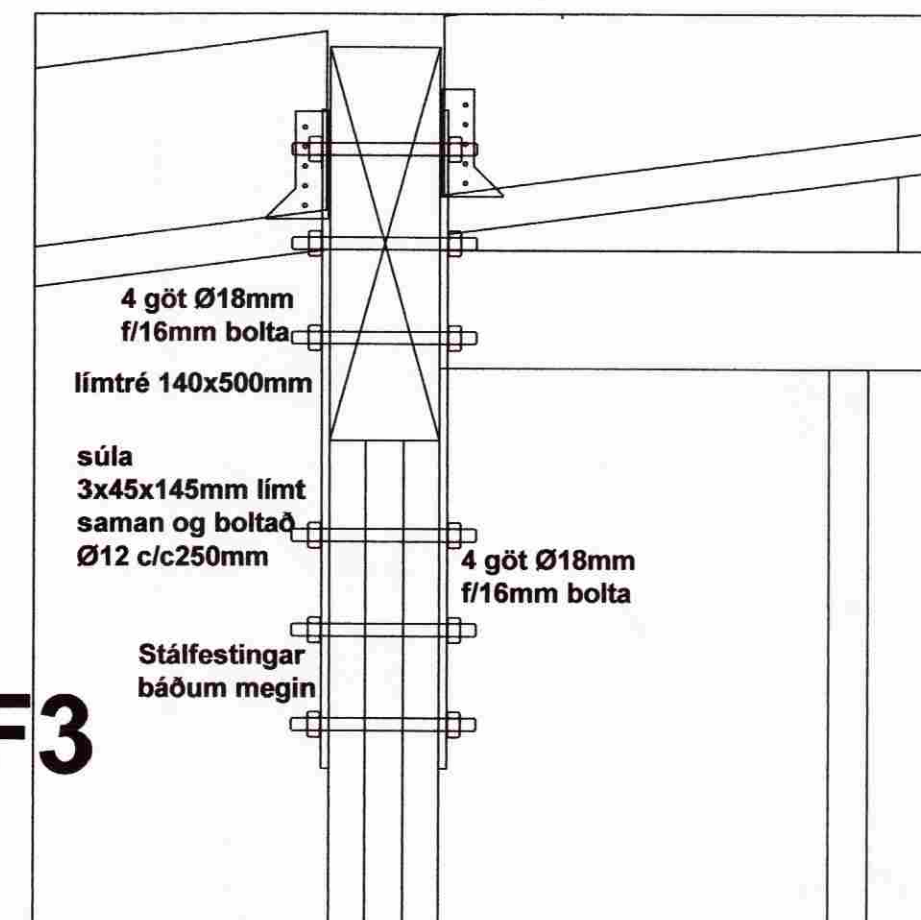
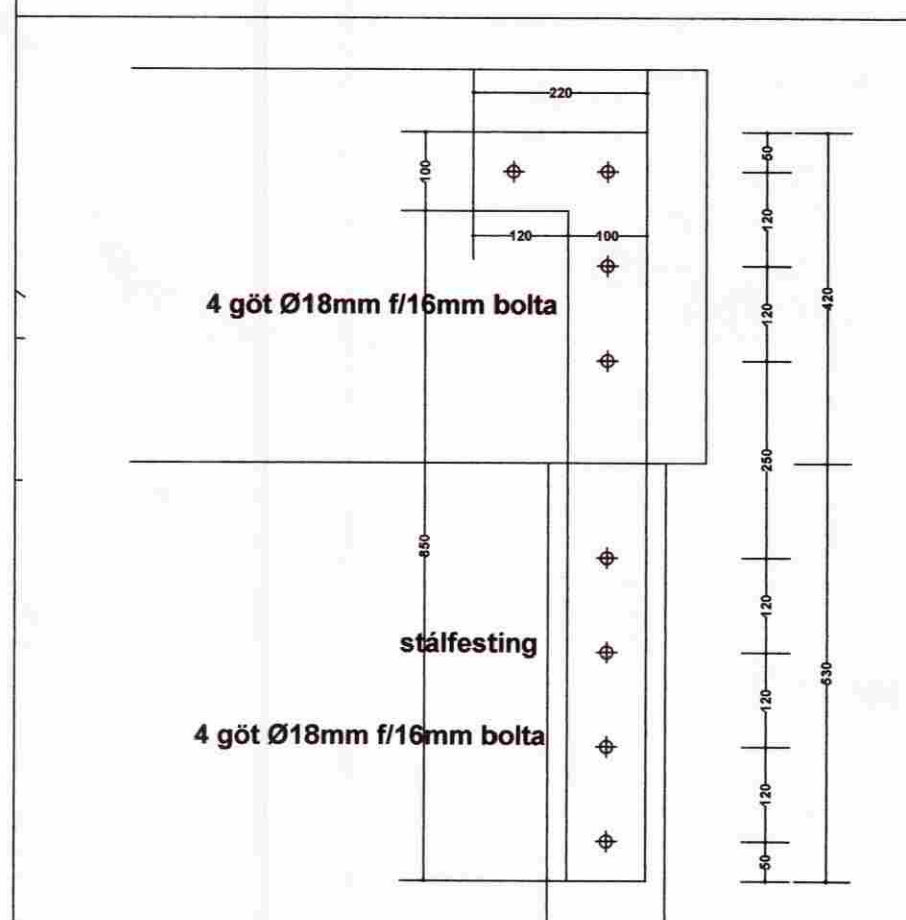
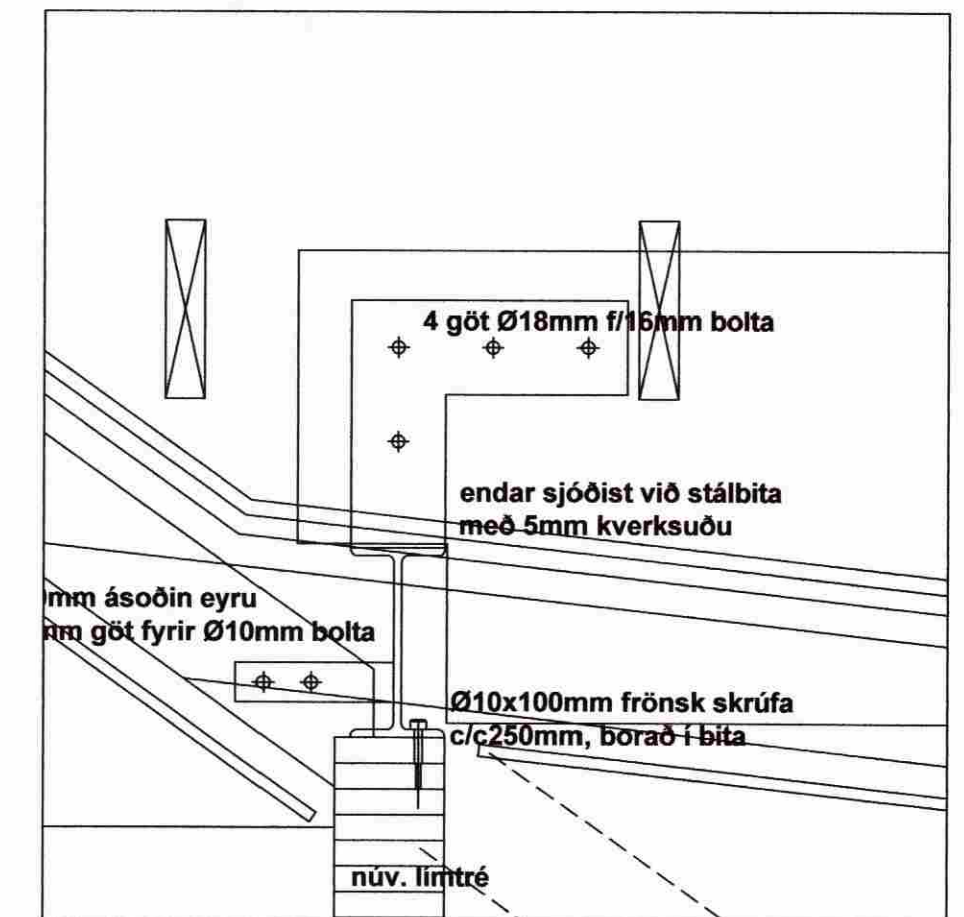
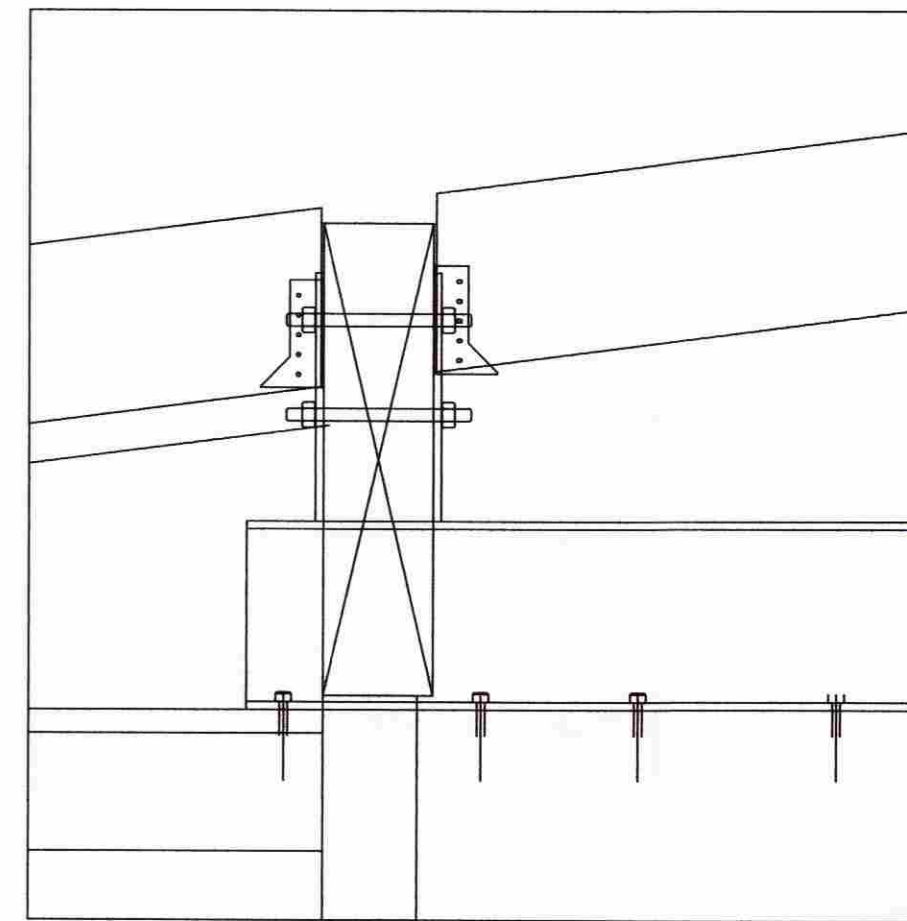

F3

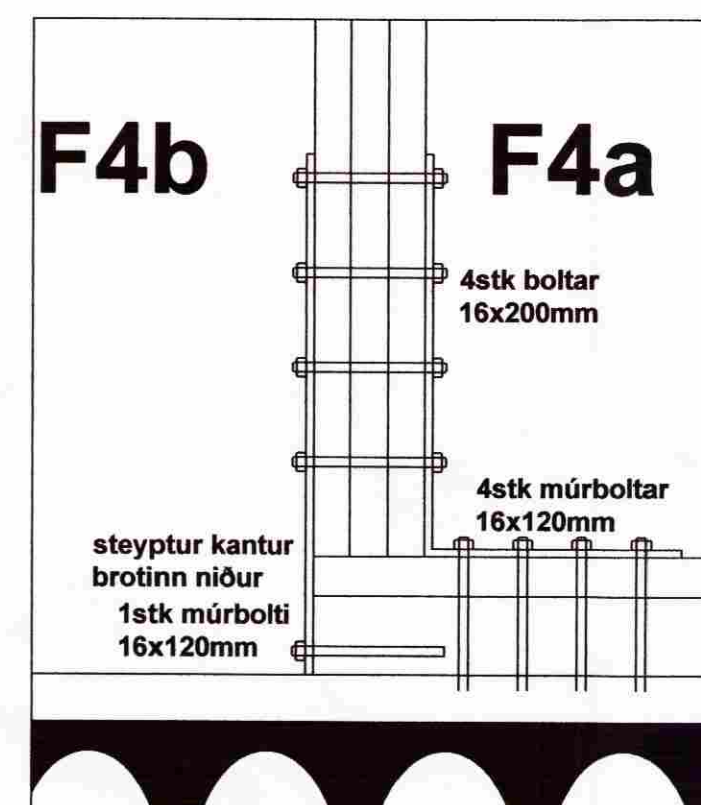

Mkv. 1:10

Skýringar á bl. nr. 4 og nr. 5

Breytingar			Golfskáli Öndverðarnesi Grímsnes- og Grafningshreppi	Mkv. 1:10
Nr.	Dags.	Nafn		
			Tækniþjónusta Ragnars G. Gunnarssonar ehf.	Nr. 7
			fax/s: 5445350 ragnargg@simnet.is	Dags. 2009.01.10
			Snið í þakvirki og skýringar.	kt.:110947-2839

*Ragnar G. Gunnarsson*

*Steph G. Gunnarsson*