

SAMÞYKKT
29. MAJ 2013
Þorgerður Þorvaldsson
Sýning, hönnun, uppbygging og flóahár.

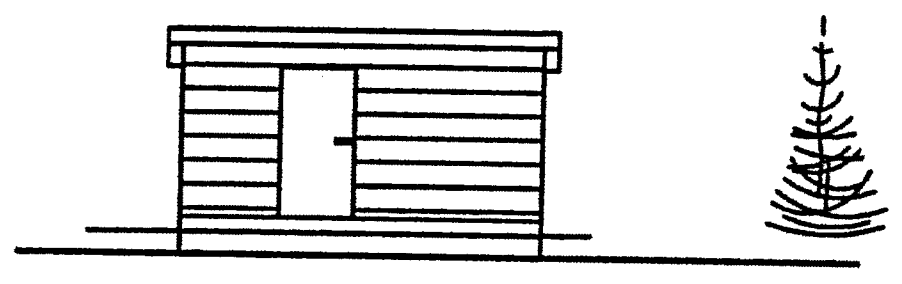

ASTUR

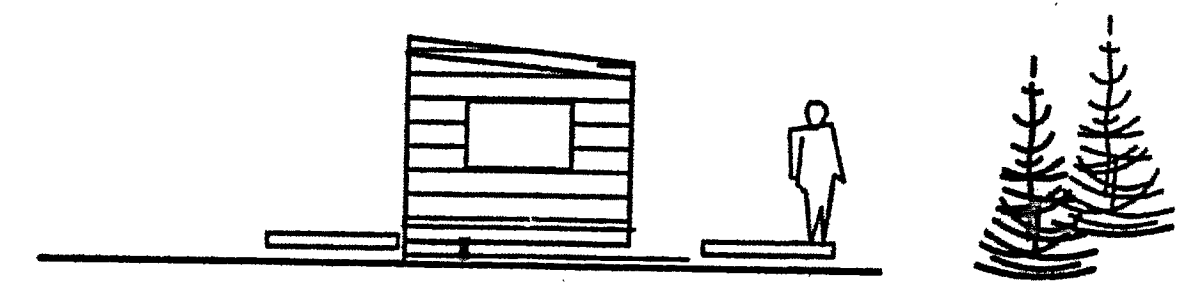

NORÐUR

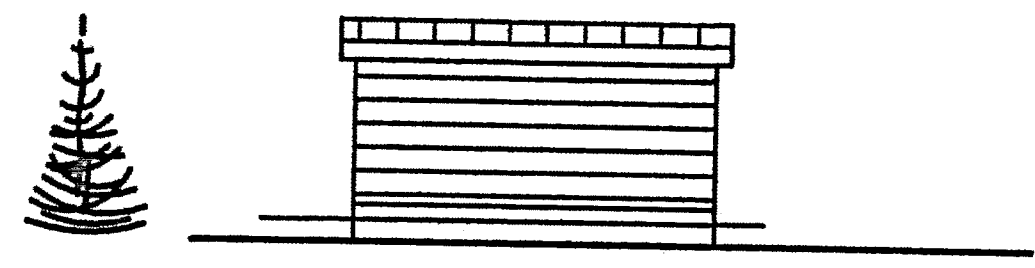

VESTUR

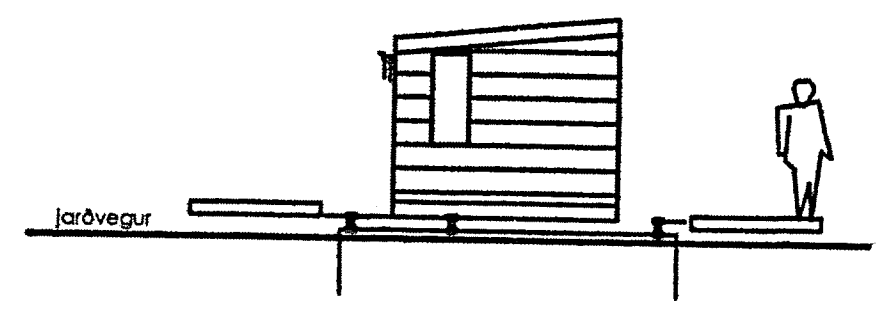

SUÐUR

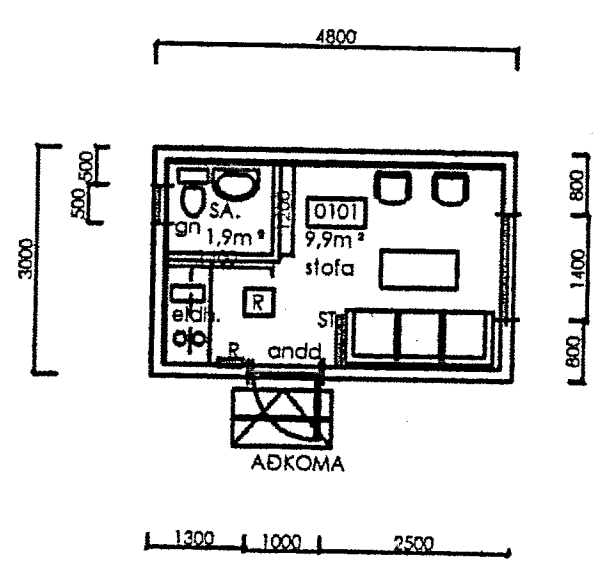

GRUNNMYND

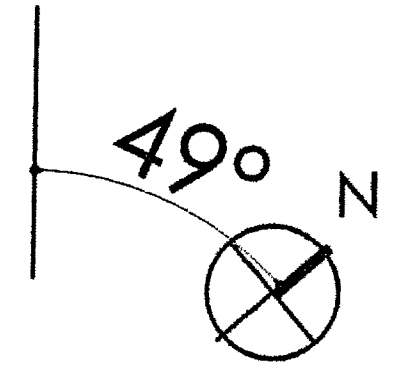

BÁRUJÁRN
PAPPI
KLÆDNING 1" X 6" 25 X 150
SPERRUR 2" X 8" 50 X 200 MM CC 600
LOFTRÁS 30 mm PER SPERRUBIL
ENANGRUN, ÞAKULL 175 MM
RAKASPERRA
LAGNAGRIND,
PLÖTU EDA PANIL KLÆDNING, FL. 2

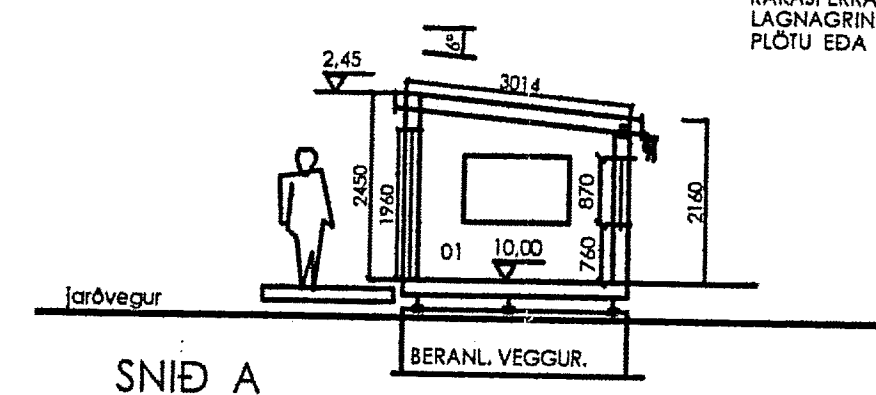

SNIÐ A

LÁRÉTT KLÆDNING BÁRUJ,
LÖÐRÉTTIR 10 X 50 MM LISTAR F. ÚTLOFTUN
KROSSVIÐUR VATNSLÍMDUR 11 M/M
STODIR 2" X 5", 50 X 125 C/C 600 MM
EINANGRUN ÞÉTULL 125 MM
RAKASPERRA
LAGNAGRIND, PLÖTUKLÆDNING

22 MM NÓTADAR SPÓNPL.
GÓLFBITAR 2" X 6" 50 X 150 C/C 600 MM
EINANGRUN ÞÉTULL 150 MM
KROSSVIÐUR Á LISTA, UNDIR EINAGRUN
DREGAÐAR 3 STK. STÁL IP 180 MM
ERU FESTIR MED AKKERUM Í ST. UNDIRVEGG.
UNDIRSTÖÐUVEGGIR: Þ. 300, H. 600 MM. L. CA. 3500 MM.
AFRÉTTINGAR EFNIR UNDIR BERANLEGARA VEGGJAL.
GRAFÍÐ NIDUR Á FAST, OG FROSTFRÍTT BERANLEGT EFNIR

- SKÝRINGAR:
- BO BJÖRGUNAROP
 - REYKSKYNJARAR
 - ST. SLOKKVITÆKL
 - SA. SALERNIL
 - LR LOFTRÆSING.
 - GN GÓLFNIDURFALL
 - MÆLAGR. INNTAK F. VATN
 - R INNTAK F. RAFM.
 - ☼ ÚT
 - Ⓡ ROTÞRÓ

ML 02

STÆRD HÚSS: 14,4 M²
NR. 1 *Laustary.* 30.5/13

SUMARHÚS.
HVAMMAR NR. 15,
GRÍMSNES. GRAFNINGSHR.

LNR 168422 SG. 1 1260 0150 EIGANDI: *SG*
HVAMMAR NR. 15. GRÍMSN. OG GR. teikn. A2

DAGS: 1, 11, 2012 ADALTEIKN 1: 100
ARTIK TEIKNISTOFA GSM 895 - 9202
SÍMI 421 - 4122

STEINAR H. GEIRDAL BYGGINGAFRÆÐINGUR B.F.I.
040138 3829 DRANGAVELLIR NR. 2, 230 KEFLAVÍK

AA02