

Heimtaug

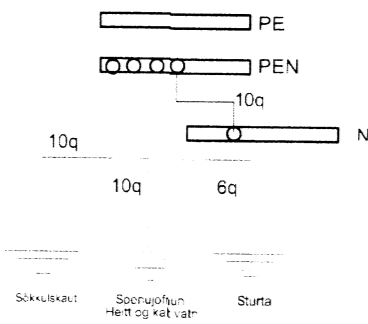

Skipulags- og byggingarfulltrú
Uppsveita bs.
30. des. 2014
MÓTTEKIÐ

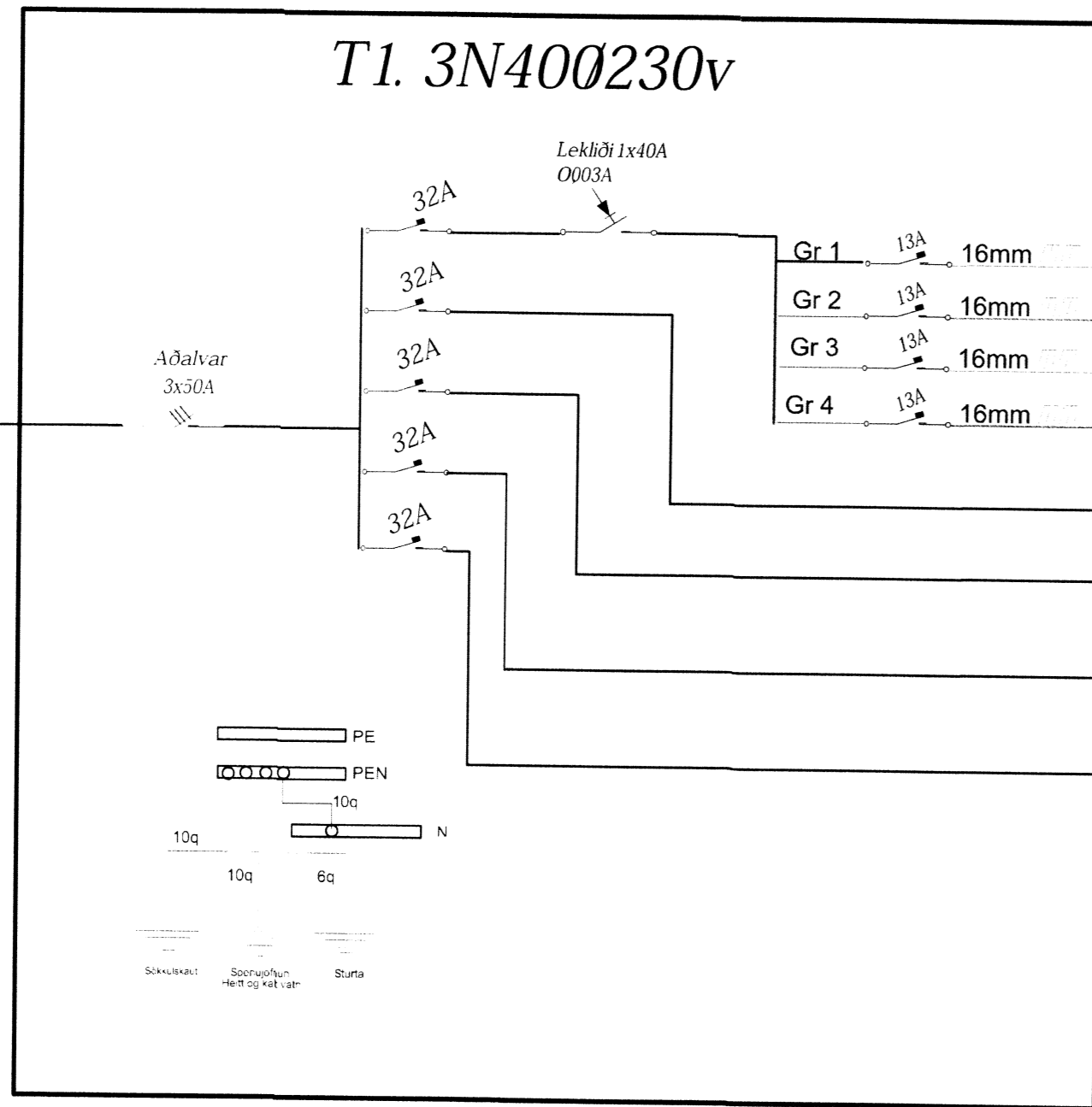
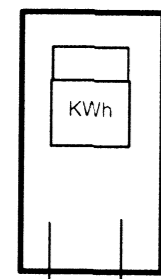
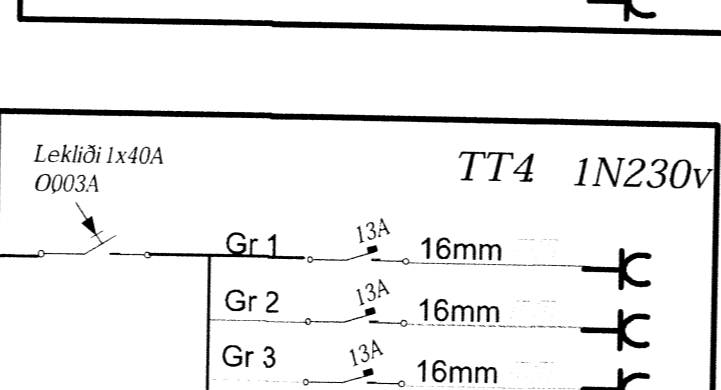
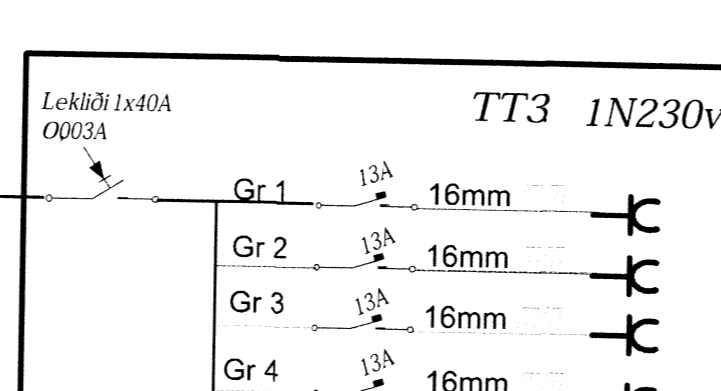
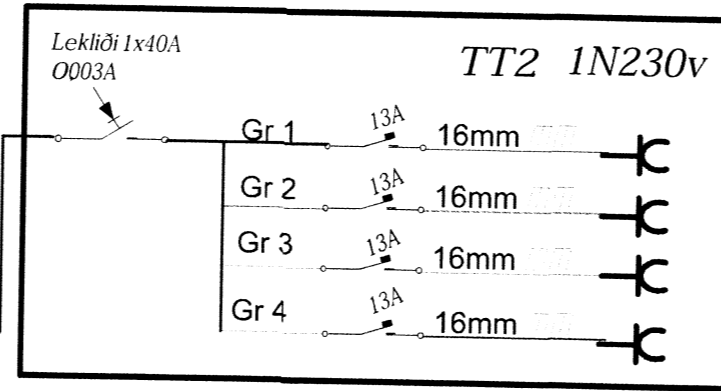
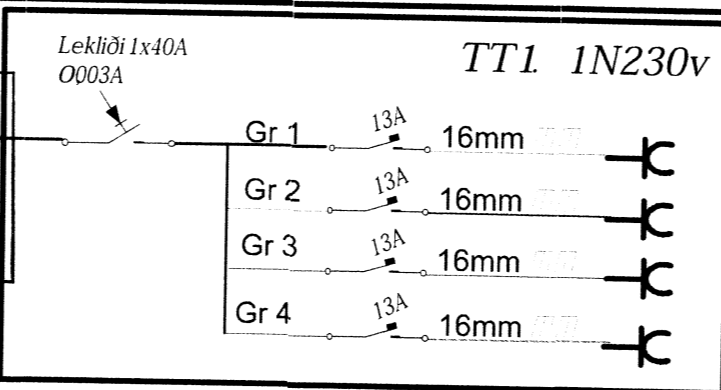

Raflagnþjónusta Selfoss ehf. Gagnheiði 5. 800 Selfoss Símar 894-5408 / 899-5408

Dags 18-12-2014	Staður. Selgistihús. 801 Selfoss.
Hönnuður Raflagnateikningar.	Hönnuður Raflagnateikningar. Sveinn Eliasson Kt 2808723189.
Teikning: Einlínmyndatöflu. 4	Eigandi
Breitt	Kvarði

