

SNID C-C 1:20

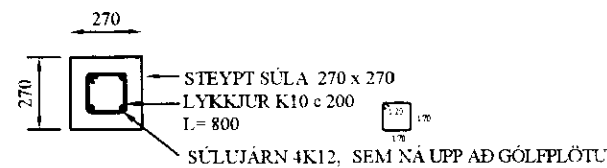

SNID G-G 1:20

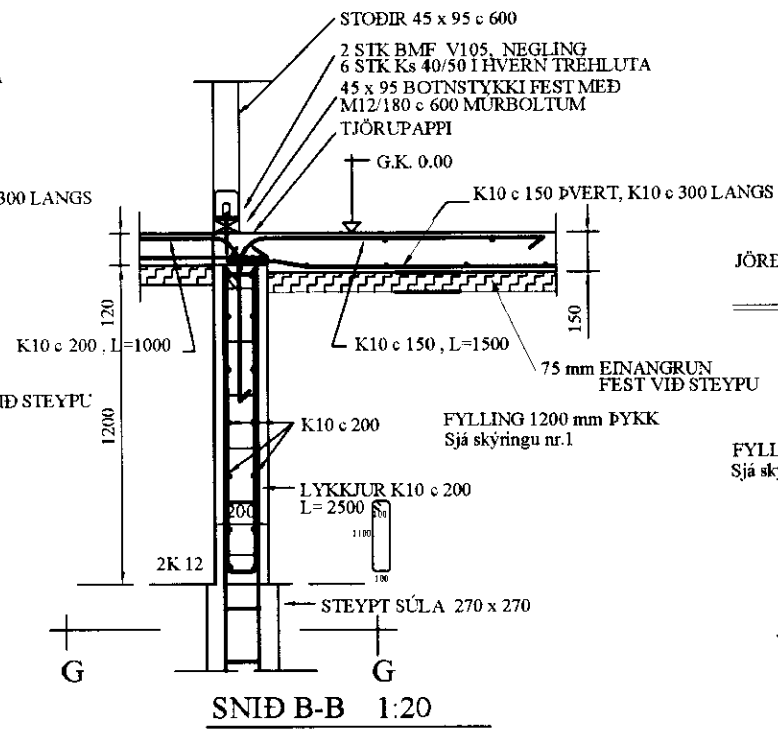

SNID B-B 1:20

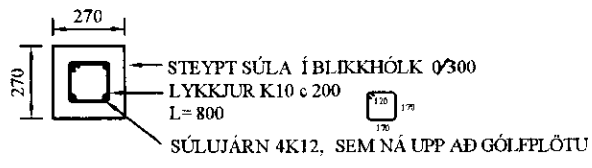

SNID G-G 1:20

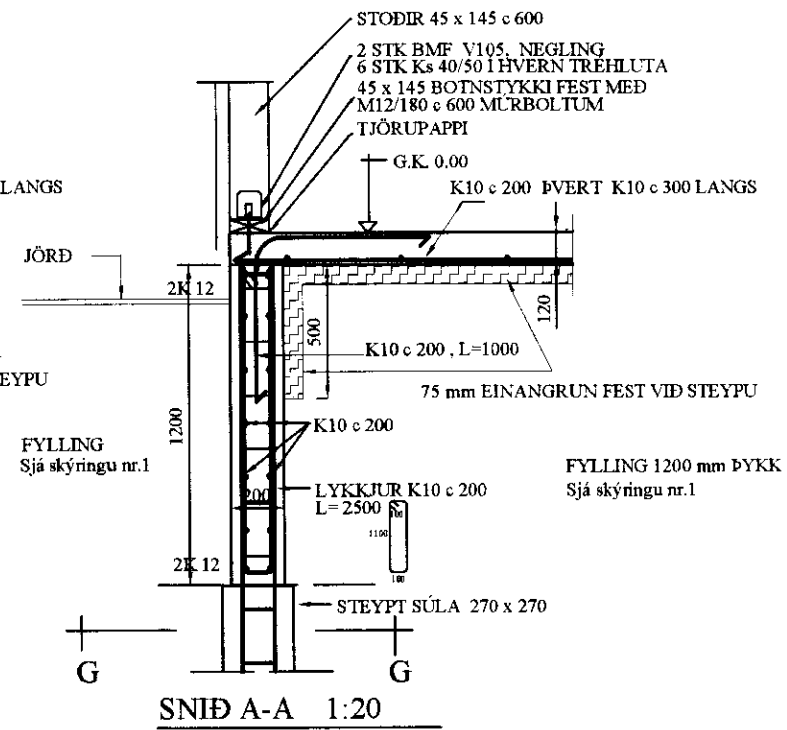

SNID A-A 1:20

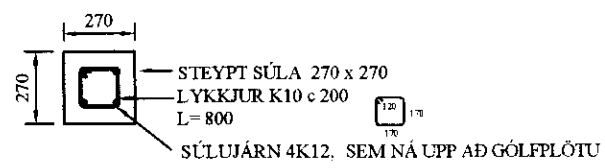

SNID G-G 1:20

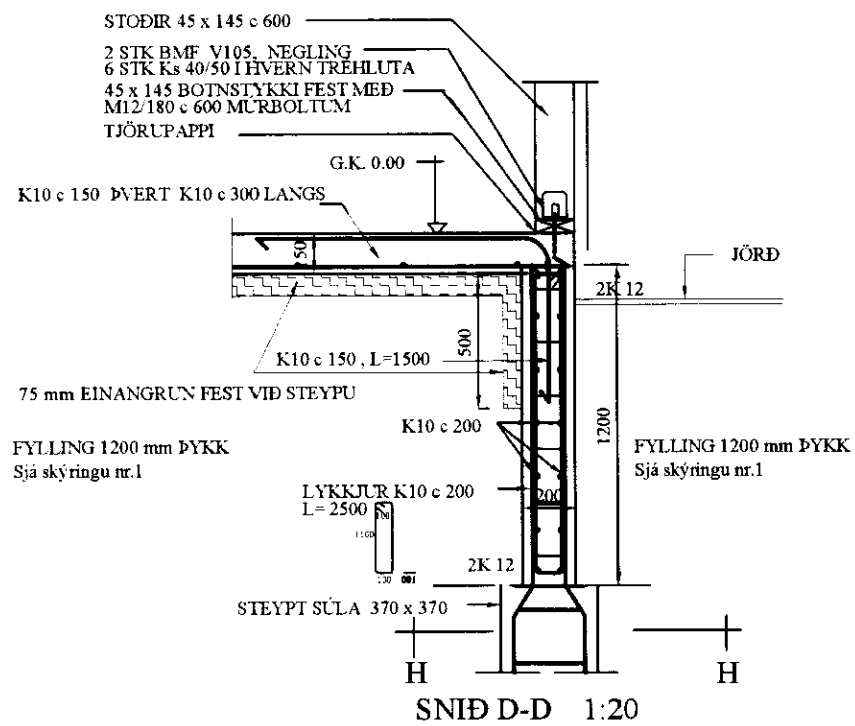

SNID D-D 1:20

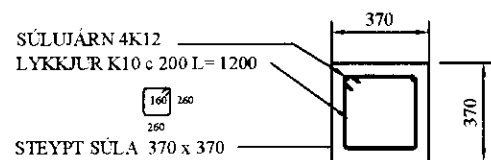

SNID H-H 1:20

ATHS.

Sjá Grunnmynd á BL.1.01

SAMÞ. ARKITEKTS:

D10	B10
D9	B9
D8	B8
D7	B7
D6	B6
D5	B5
D4	B4
D3	B3
D2	B2
D1	B1

Nr.	Dags.	Breyting varðar	Nafn
-----	-------	-----------------	------

Kópavogi JANÚAR 2005

Teikn. G.Ó. Kvarði 1:20

Reikn. G.Ó. Verk nr. SI-05 Bl. nr. 1.02

Yfirf. G.Ó.

Samþ. *Guðmundur Oskarsson* 080332-4249

STADUR: ÞRÁNDARTÚN 1

EFNI: BURÐARVIRKI UNDIRSTÖÐUR SNID AF BL.1.01

Verkfræðisþjónusta
Guðmundar Oskarssonar
Ráðgefandi verkfræðingar

Engihjalla 11, 200 Kópavogi 588 4030 893 6425
vgo@simnet.is