

SNID 1-1, LAGIR SÖKKLAR  
JARÐFYLLING AÐ VEGG  
M. 1:20

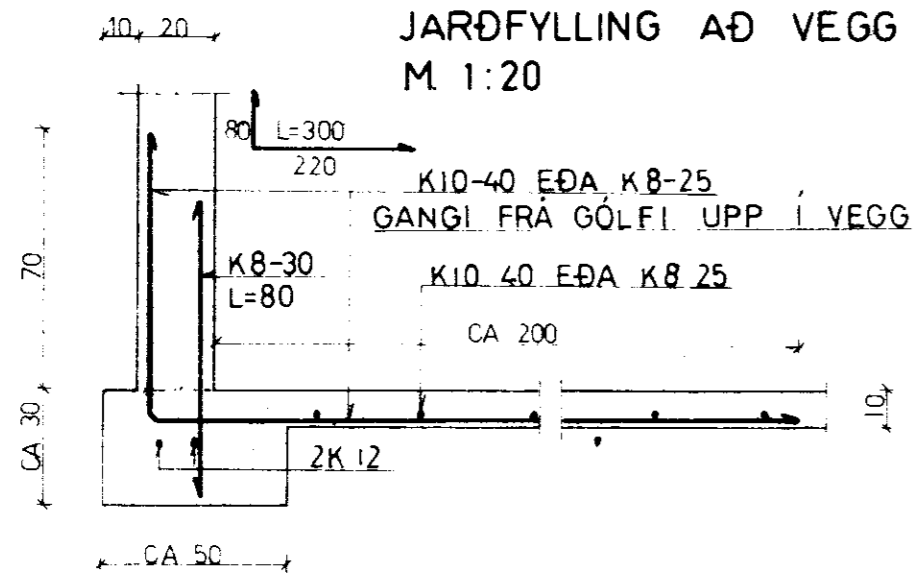

SNID 2-2 HÁIR SÖKKLAR  
JARÐFYLLING AÐ VEGG  
M. 1:20

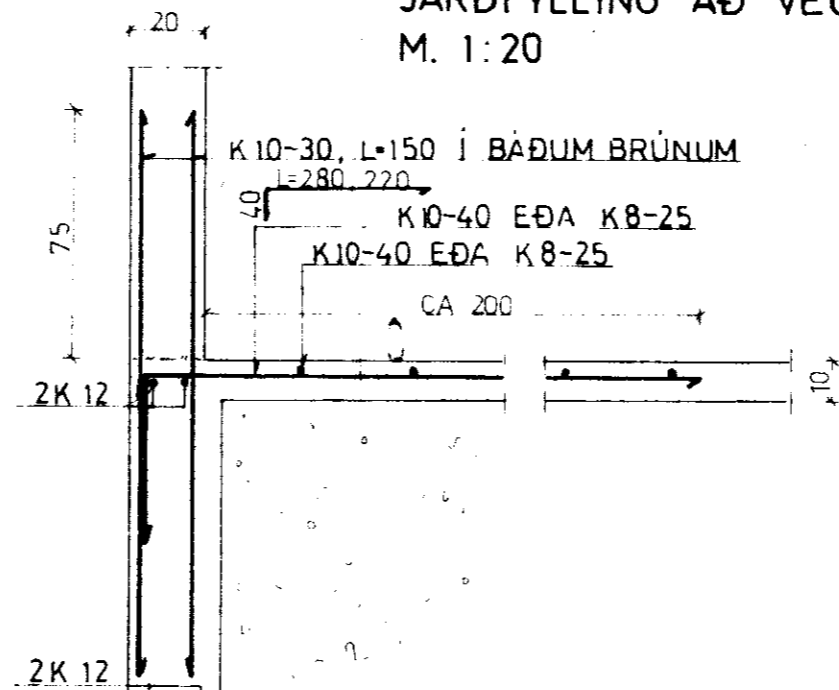

STOÐ MED UNDIRST.  
M. 1:20

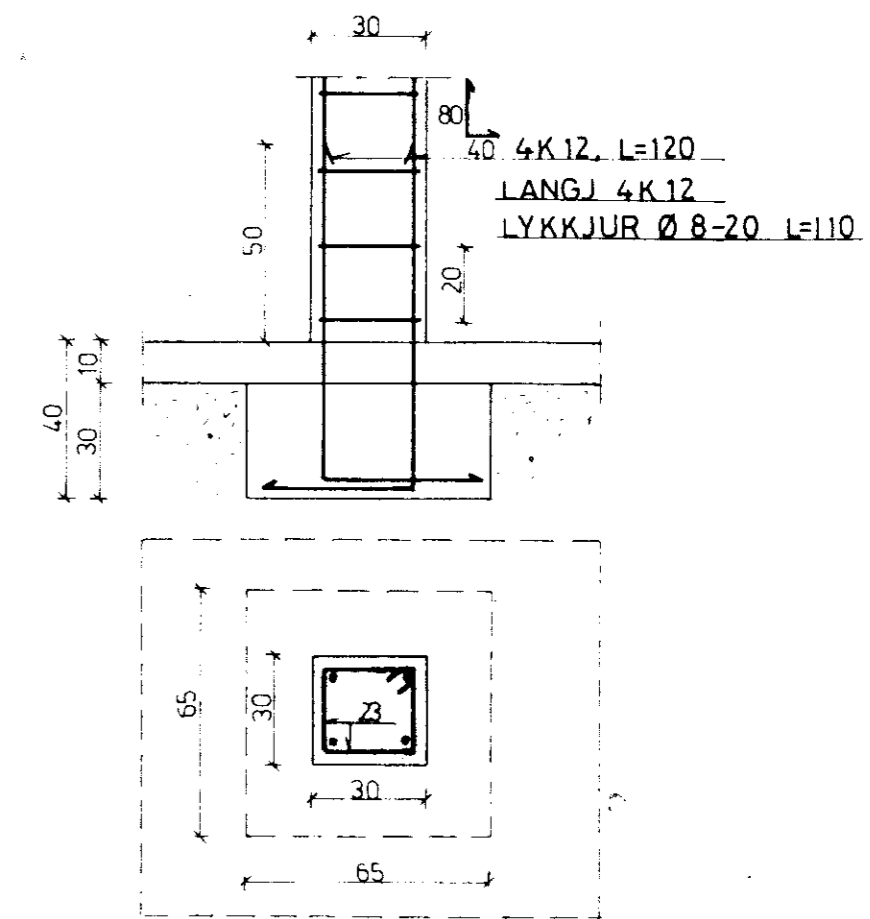

SNID 3-3, LAGIR SÖKKLAR  
LITIL JARÐFYLLING AÐ VEGG  
M. 1:20

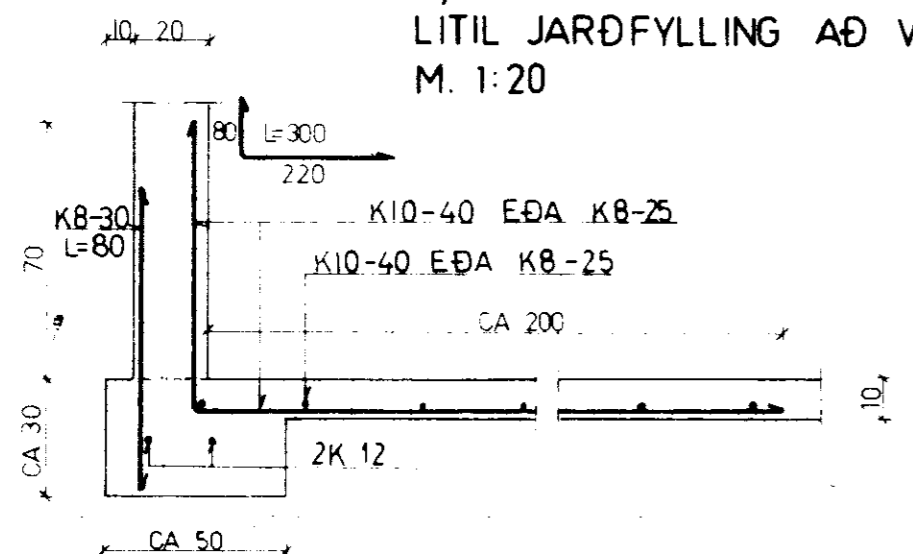

SNID 4-4 HÁIR SÖKKLAR  
LITIL JARÐFYLLING AÐ VEGG  
M. 1:20

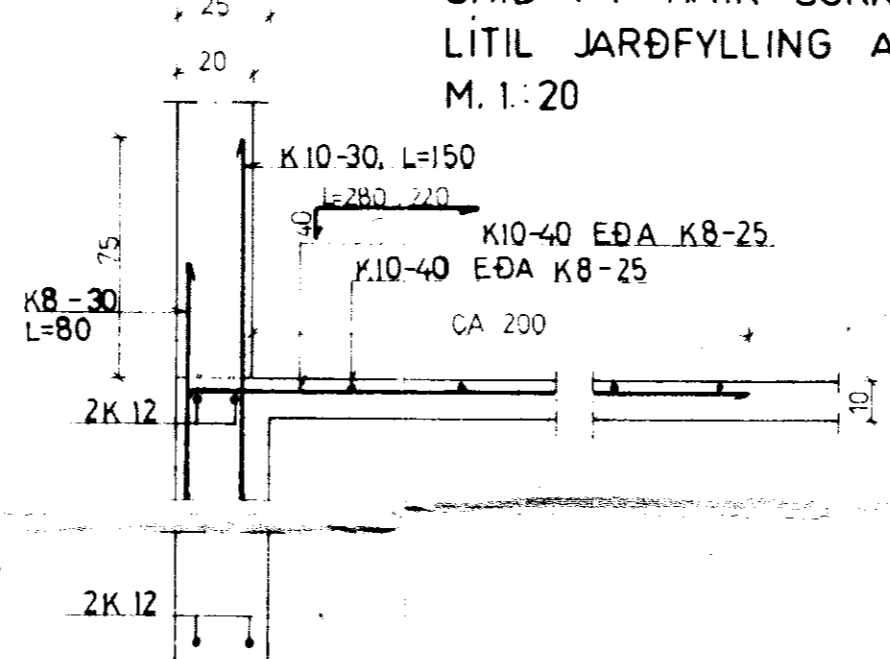

STOÐ V,

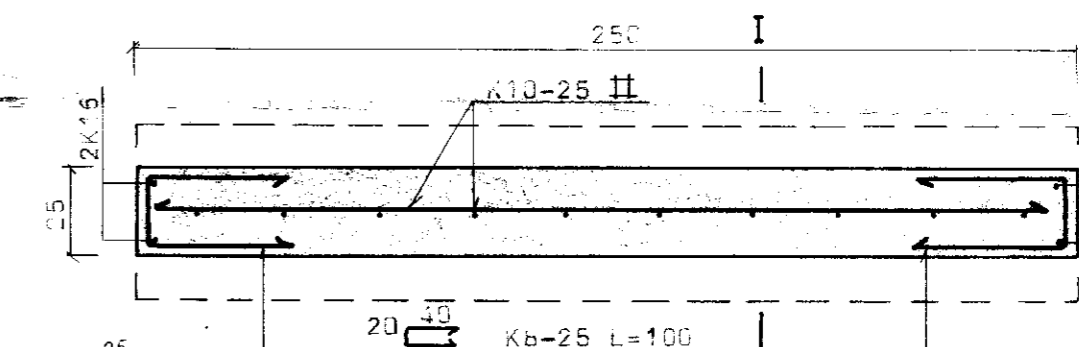

SNID I-I  
M=1:20

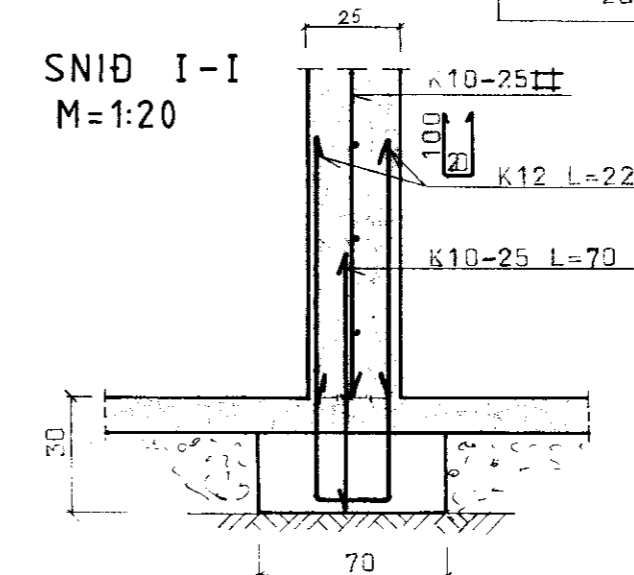

SÖKKULGERÐ SKAL VALIN (SNID 1-1, 4-4)  
EFTIR STAÐHATTUM Í SAMRÁÐI VIÐ  
BYGGINGARFULTRÚA

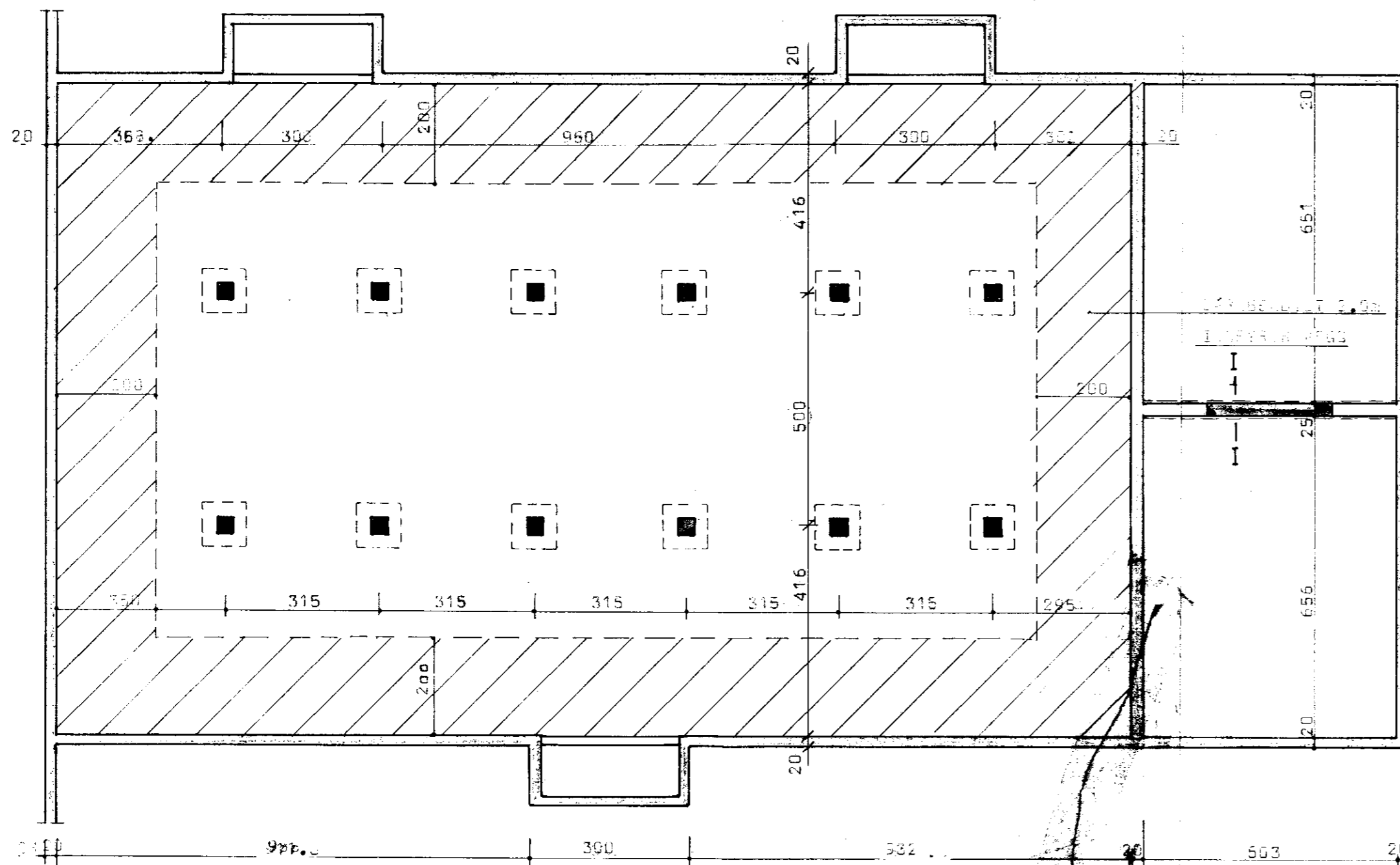

BL 10-4693 VESTURKOT SKEIÐAHR, ARNESSÝSLU

BL BYGGINGASTOFNUN LANDBÚNAÐARINS (S.25444)

HAUGHÚSBOTN

Malkv.

1:100

1:20

Reikn.

Tekn.

Samb.

Reykjavík, JAN 1985

*Pj. Sigvaldason*

Verkefni nr.

1

Breytingar