

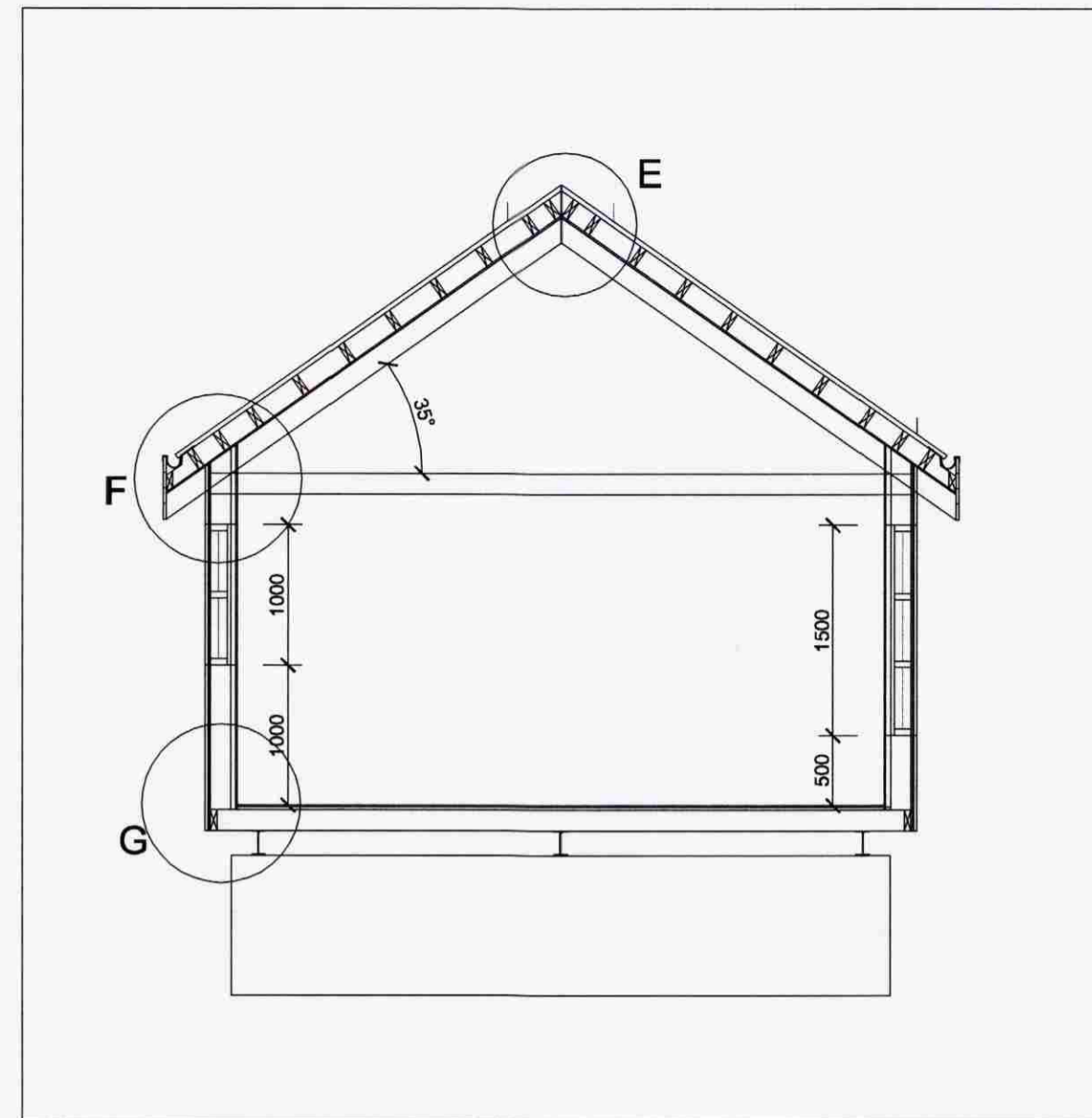

MÓTTEKID

09 JUNI 2009

Byggingafultrúi uppsv. Ámessýslu og Flóahf.

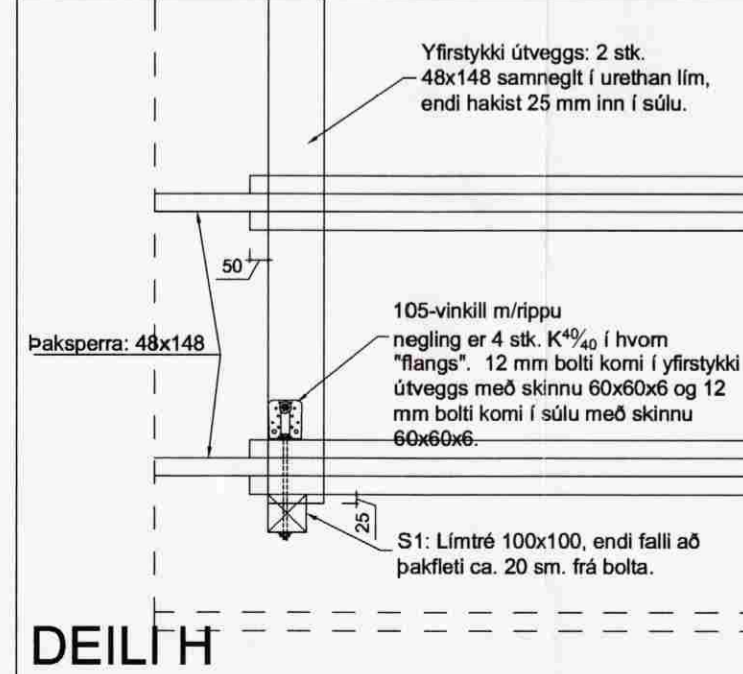
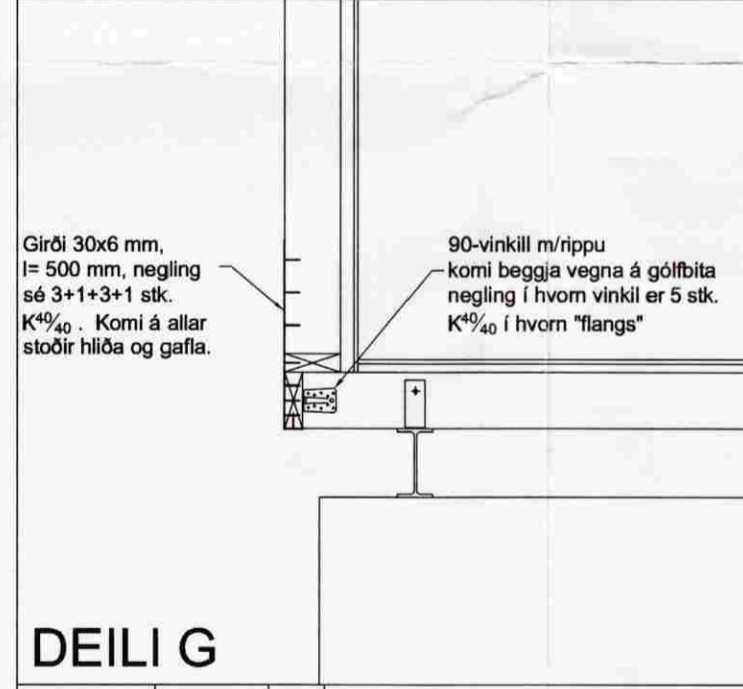
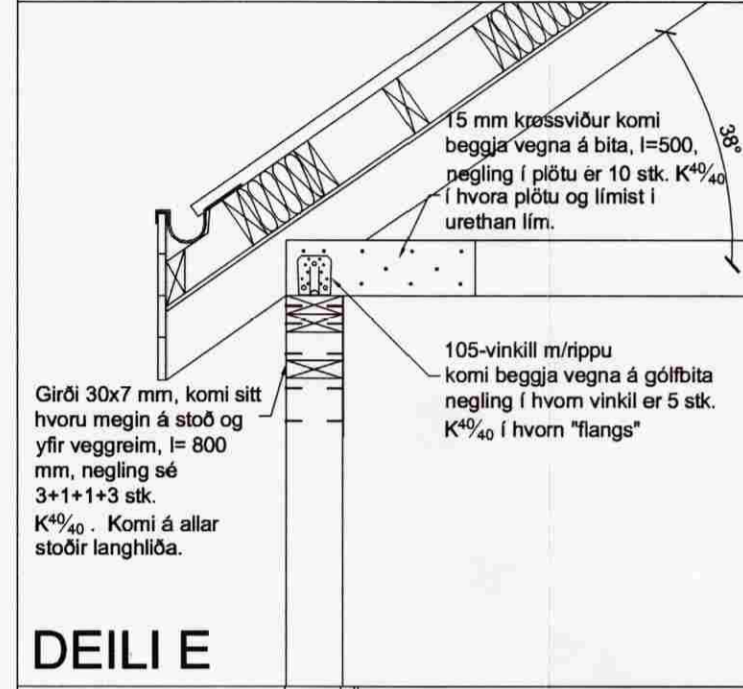
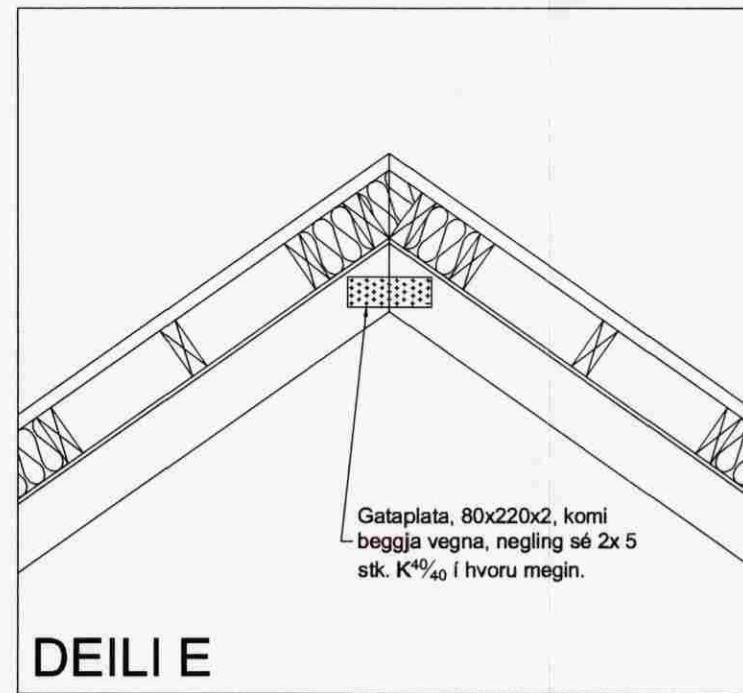
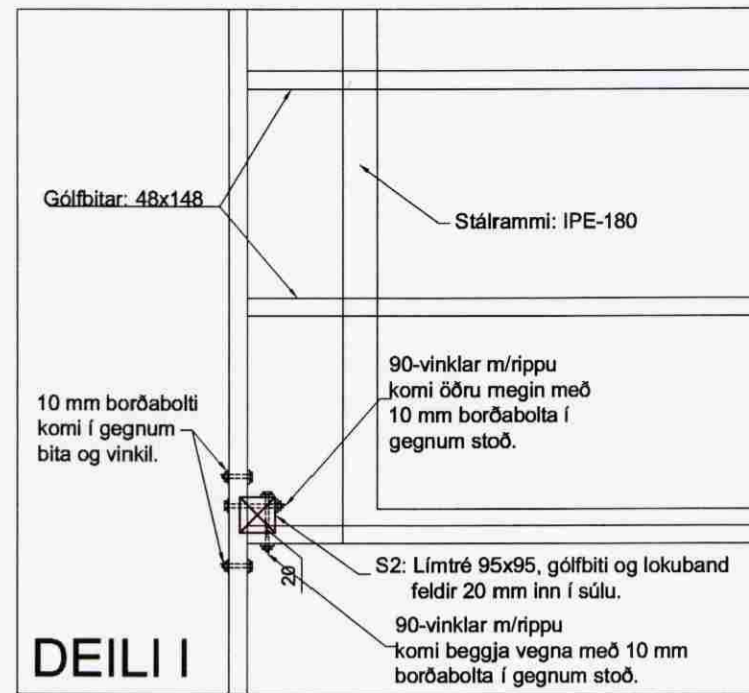
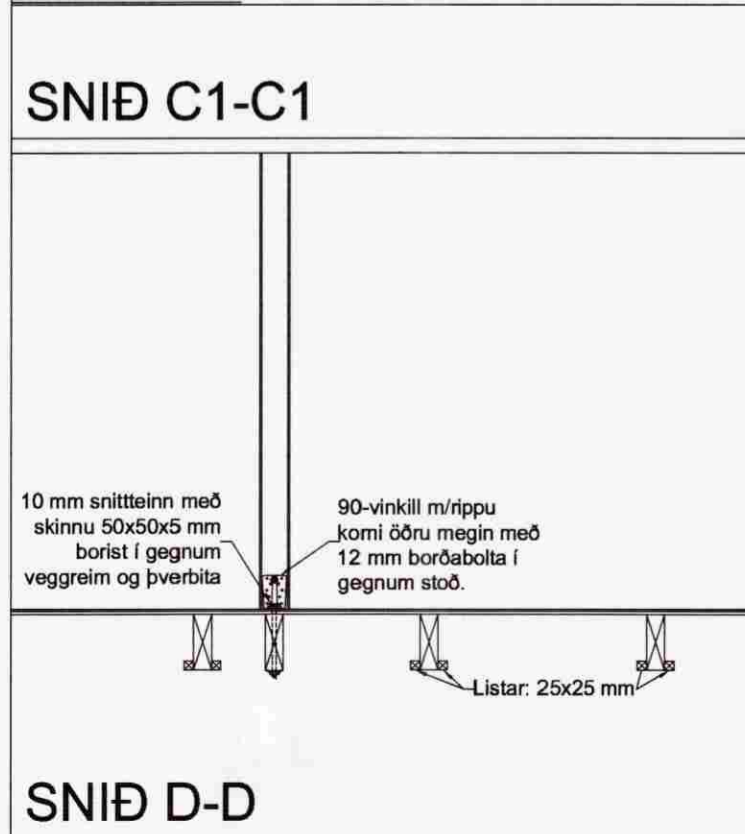
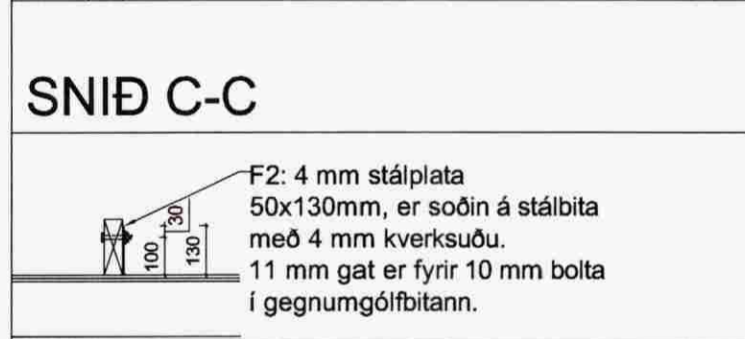
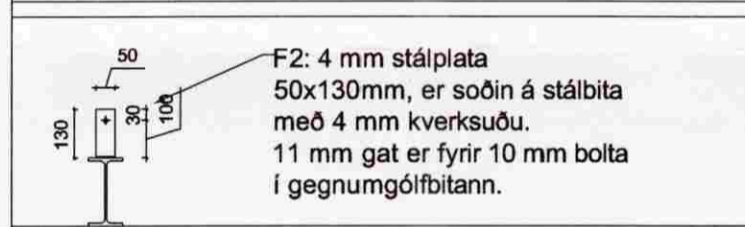
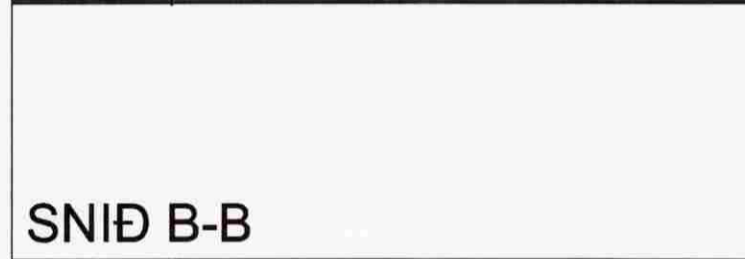
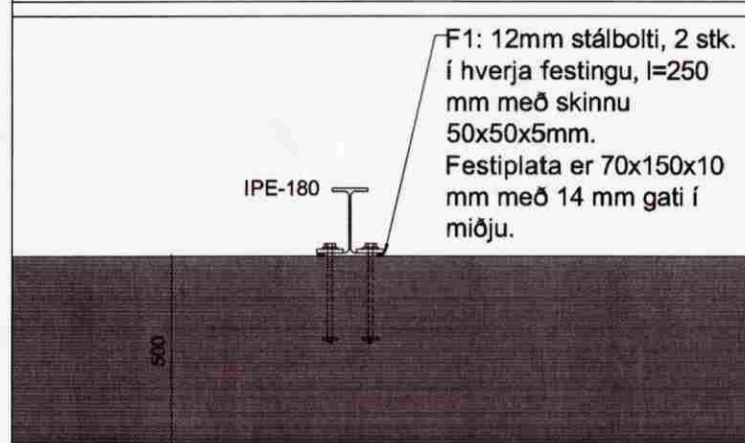
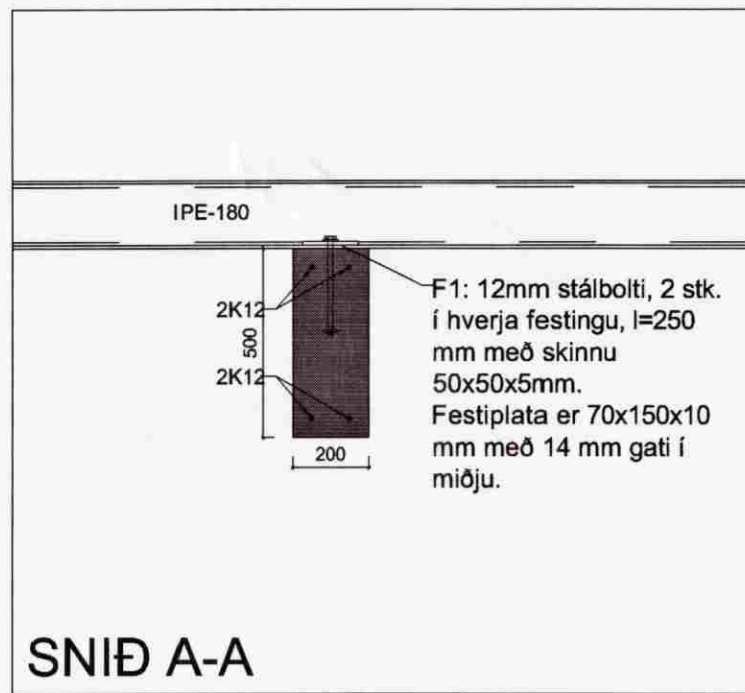

Sumarhús með grindarmál 6,0 x 13,3 m og þakhalla 35°.

Breytingar:	
	Teikni- og verkfræðisjónusta. SELFOSSI
Vinnustofa:	Stóru-Sandvík 4, 801 Selfoss. Sími 482-1738 / 898-9199 Netfang: sams@simnet.is
Áb.m. og réttahafi ©:	Samúel Smári Hreggviðsson, byggingateknifræðingur, M.T.F.Í. Kt.: 200752-4659
Viðfangsefni:	AUSTUREY LÖÐ 167688 Bláskógabyggð
Verkhúti:	UNDIRSTÖÐUR, STÁLRAMMI, GÓLFBITAR, SNID OG SKÝRINGAR
Mælivarði:	Teiknað/Reiknað: 1:50 og 1:20 ssh
Dagsetning:	Stóru-Sandvík 4, í júní 2009
Samþykkt:	
Verknúmer:	S1L-07,19
Teikn.nr.:	2-03