

G2
3 stk

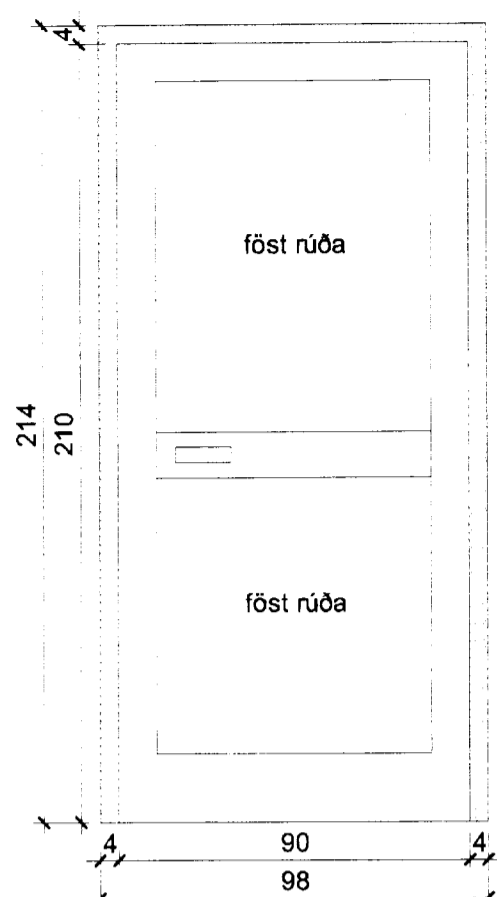

H5
1 stk

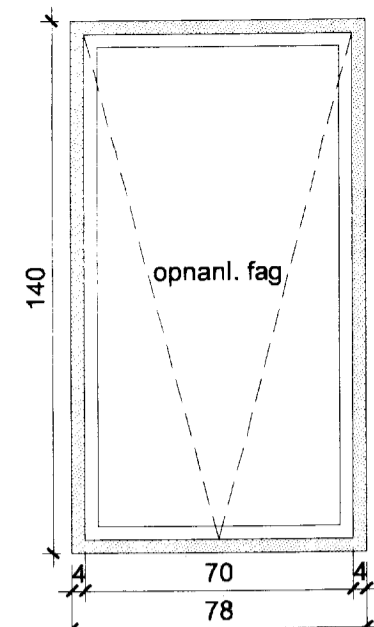

G3
1 stk

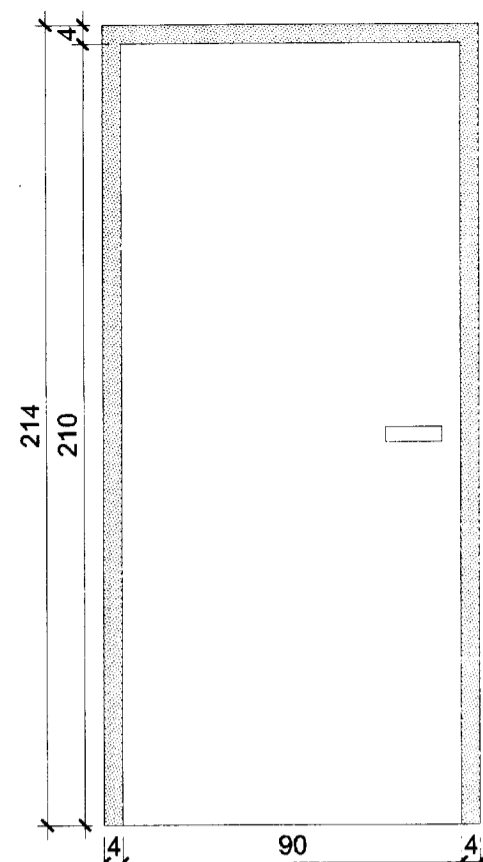

H6
4 stk

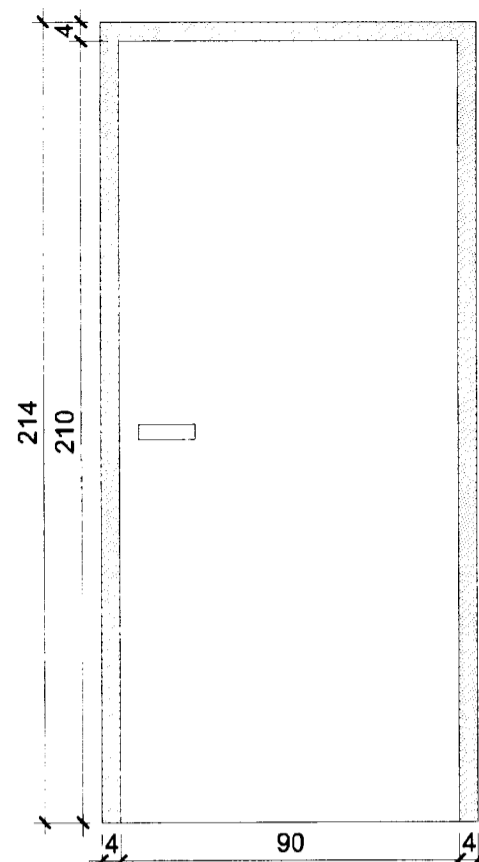

H7
1 stk

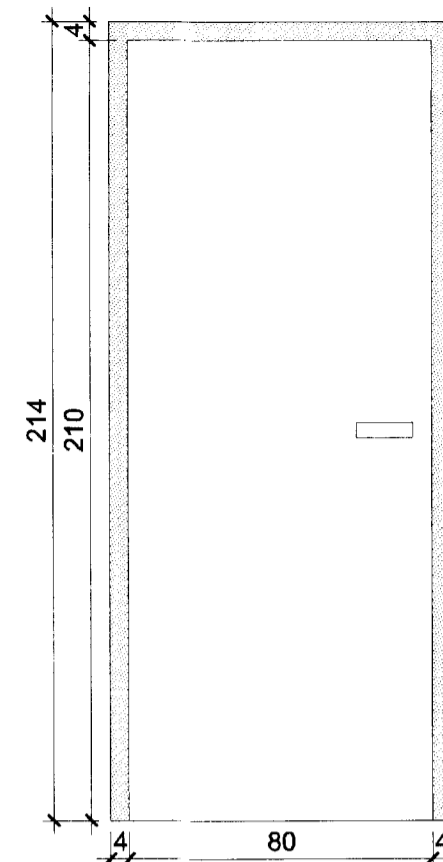

H8
1 stk

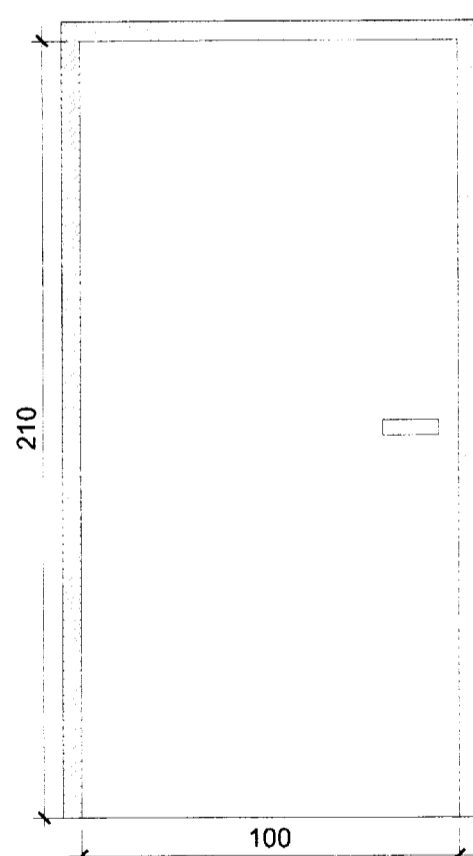

H9
1 stk

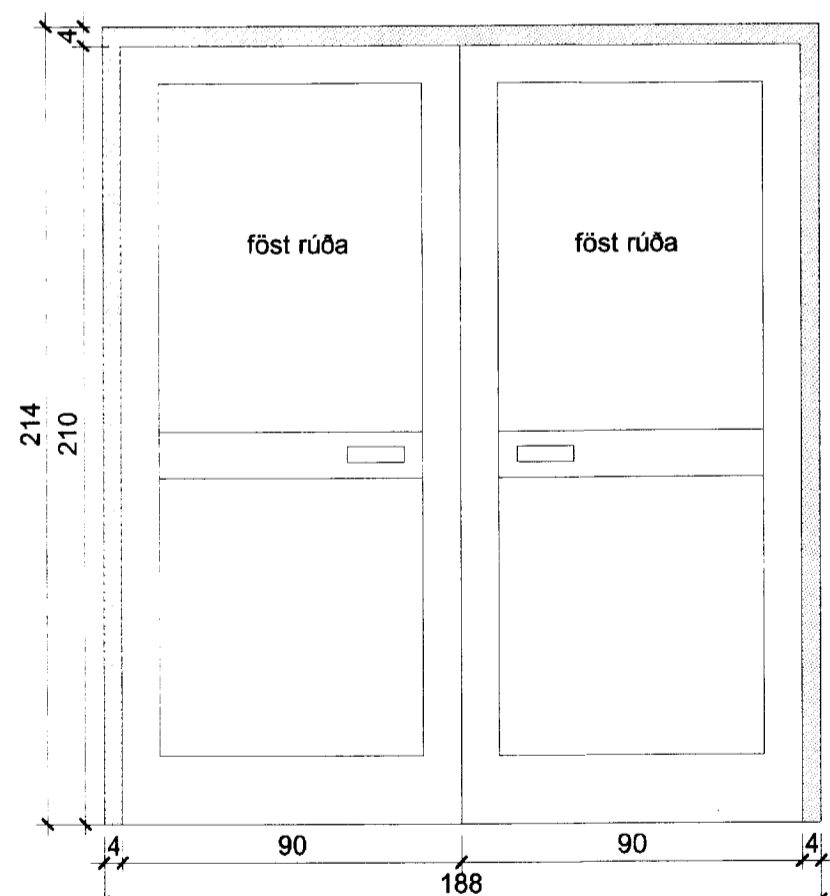

H10
1 stk / EI-CS30

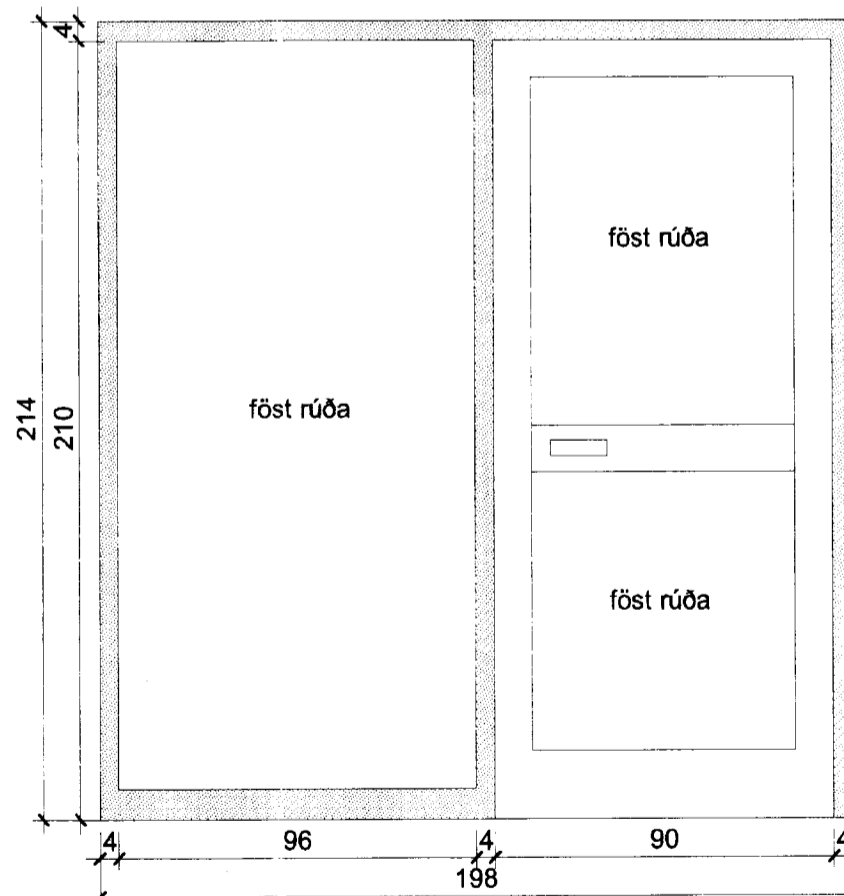

H11
1 stk

MÓTTEKID
03 APR 2010
Byggingafulltrúi uppsv. Ámessýslu og Flóahv.

ATH: Misræmi í teikningum tilkynnist til arkitekts strax.

SKYRINGAR
Gluggar og útihurðir eru úr furu
Tvöfalt K-gler.
Innihurðir með læsingu
Gluggar og hurðir eru merkt á grunnmynd, á útliti og á sniði.

NR. DAGS	BREYTING	
Skólabraut 4 Reykholt í Bláskógabyggð		luigi bartolozzi arkitekt kt. 130659-2099 Lungólta 11 225 Alftanesi sími og fax 5552477 luigibar@simnet.is
Sérteikning: gluggar, útihurðir og innhurðir		
Mkv 1:20 Dags 03.03.2010	Teikn. nr. 8	Reykholt02.dwg