

Skipulags- og byggingarfulltrúi Uppsveita bs.
Sampykkt
 13 JULI 2016
Rúni Pétur
 Byggingarfulltrúi

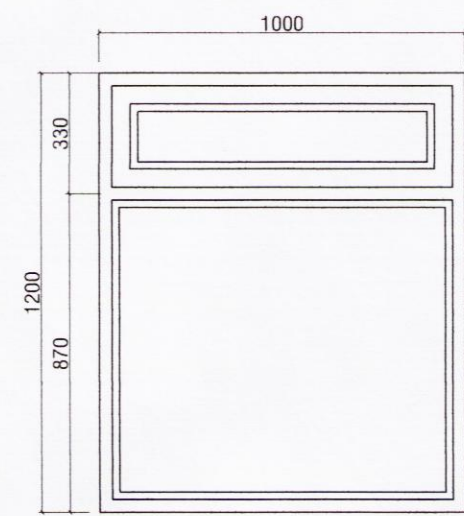

G 1 - 5 STK, ÞAR AF 3 STK OPNANL.

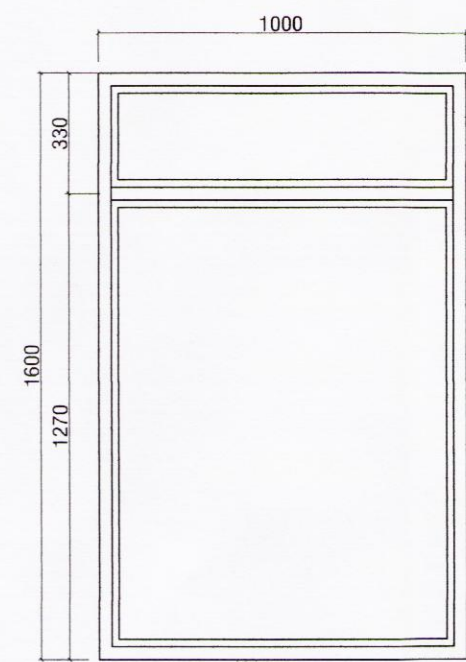

G 2 - 4 STK, ÞAR AF 2 STK OPNANL.

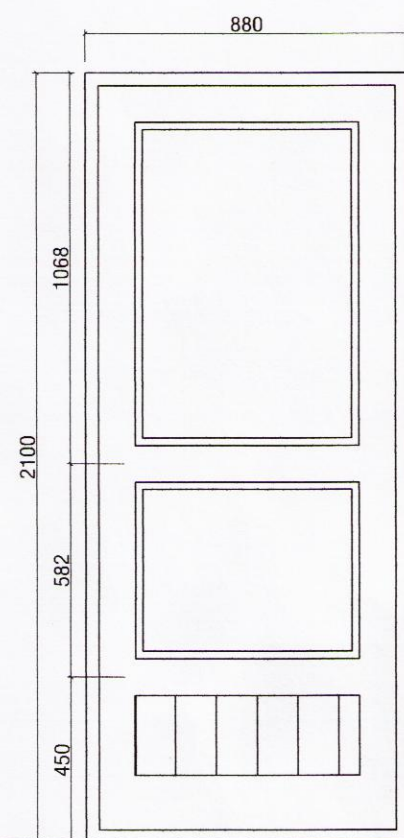

H2 - 1 STK

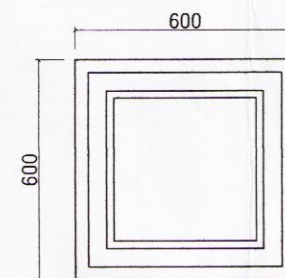

G 3 - 4 STK

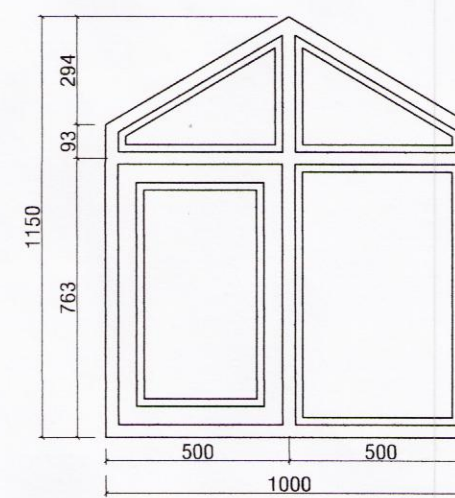

G 4 - 1 STK

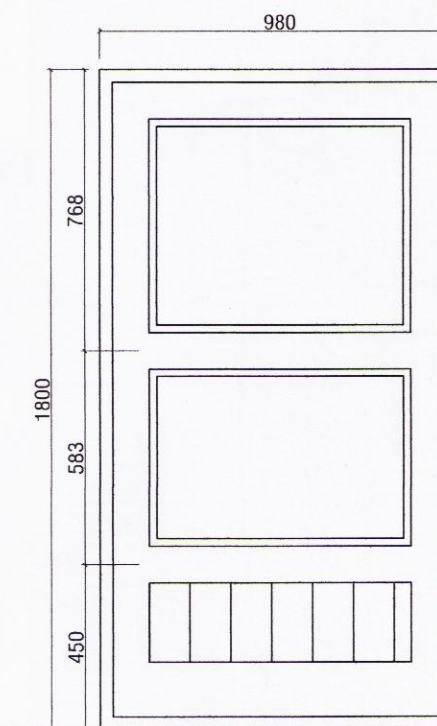

H3 - 1 STK

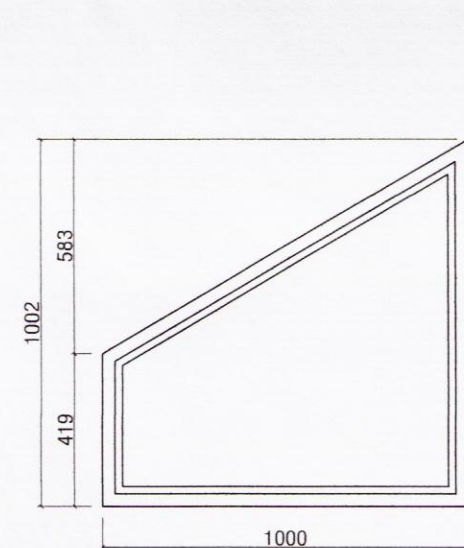

G 5 - 2 STK
 ÞAR AF 1 STK SPEGILMYND

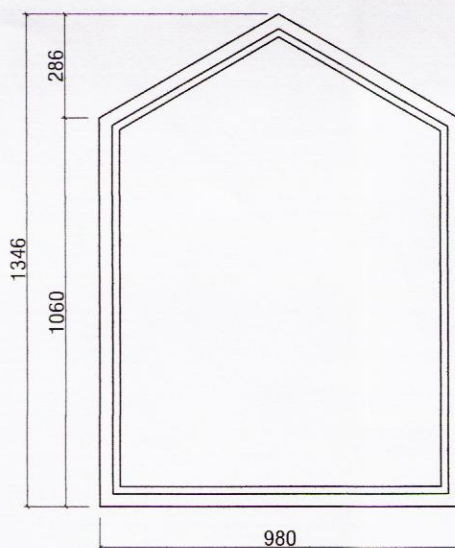

G 6 - 1 STK

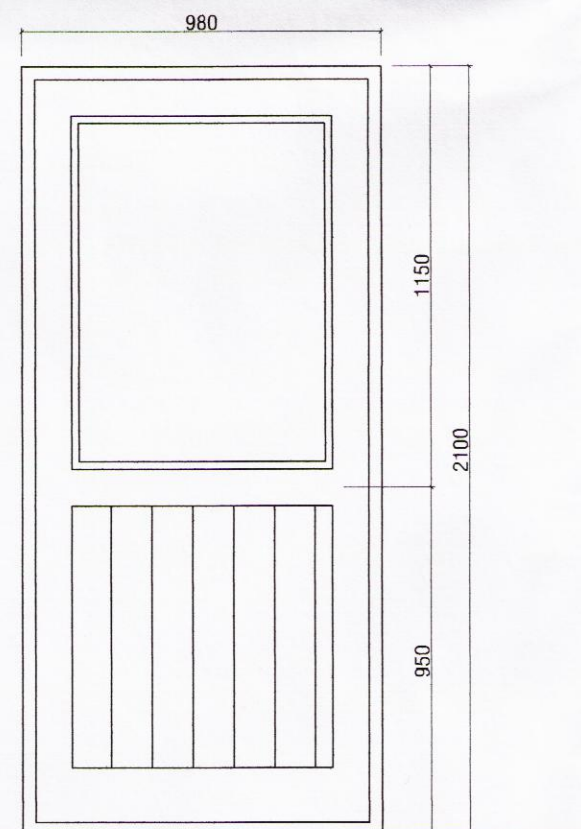

H1 - 1 STK

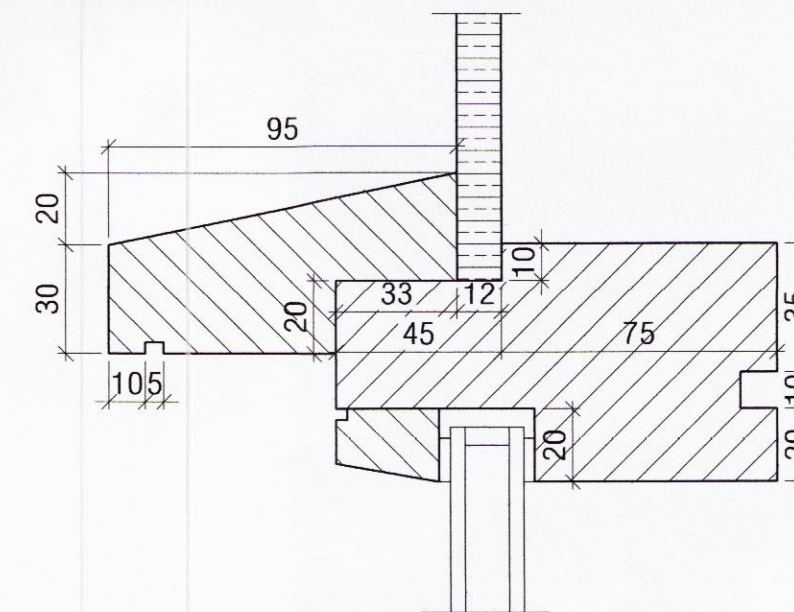

ÞVERSNID KARMS/VATNSBRETTIS 1:2

VEKTOR
 - hönnun og ráðgjöf -
 Hamraborg 11, 200 Kóp, s: 554-6650 / 897-5363

Sigurður Hafsteinsson
 byggingateknifræðingur
 Kt. 030859-7749
 email: sigurdur@vektor.is

KLAUSTURHÓLAR LÓÐ 47
GLUGGATEIKNING

Teikn. nr. Tilvisun á teikningu
 Sampykkt *Snytt*

Br. Dags.

Hannað SH Teiknað
 Dagssetning Verk nr. Málkvarði Teikn. nr.
 16.03.2016 A-04-04-10 1:20/1:2 S-04

8997