

# RAFLAGNATEIKNING

FRÍSTUNDAHÚS  
KIDJABERG LÓÐ NR. 18  
GRIMSNES OG GRAFNINGSHREPPUR

- R0 - SKÝRINGAR
- R1 - LÁGSPENNA
- R2 - SMÁSPENNA
- R3 - SÖKKULSKAUT
- R4 - AFSTAÐA OG SNIÐ
- R5 - LAGNIR GRUNN
- R6 - LJÓSAPLAN
- R7 - TÖFLUTEIKNING

G.LÁR RAF EHF  
HÖNNUN OG RÁÐGJÖF  
5107-8187  
HAFNARBÖTU 27A  
230 REYKJANEYR

HÖNNUNARSTJÓRI:  
GUÐMUNDUR ÁRNI ÞÓRÐARSSON 120986-3769

### Almennar Skýringar

Stofn frá RARIK eru í húsinu og verður 3x50A og tengist í aðaltöflu T0 í aukabyggingu! Aðaltafla T1 er veggkápur stærð 800mm x 1050mm. Í töflur skal koma allur varbúnaður sem og stjórnkerfi húsi!

Raflögnin skal vera hulin plastpípulögn og skulu pípur vera kyrfilega festar með þar til gerðum spennum og festingum. Frágangur skal vera vandaður og vel frágengin í samræmi við staðla og reglugerðaákvæði. Styðjast skal við ÍST 200

Ídregin vír skal vera í samræmi við stærð búnaðar samkv. stöðlum. Ganga skal frá dósúm þannig að þær nemi við ystu brún klæðningar. Ef tvær eða fleiri dósir eru saman skal meta hvort hægkvæmara / smekklegra er að hafa þær láréttar eða lóðrétt, sérstaklega þar sem að rofi og tengill eru saman.

Hæð rofa skal vera 110cm

Hæð tengla skal vera 20cm

Hæð fjarskiptatengla skal vera 20cm

Hæð tengla í eldhúsi skal vera 110cm

Hæð tengla fyrir eldhúsi tæki skal vera í samráði við innanhúshönnuð

Hæð tengla í þvottahúsi skal vera 750cm

Hæð tengla í geymslu skal vera 110cm

### NEMA ANNÐ SÉ GETIÐ Á TEIKNINGUM

Reyskynjarar skulu vera samkv. byggingarnefndarteikningum.

Teikningin er táknað og sýnir hvers óskað sé. Þó skal hafa samráð við innahús hönnuð og innahússmið.

### Rafbílahleðsla

Gert er ráð fyrir rafbílahleðslu frá töflu, og er 32mm rör tilbúið fyrir ídrátt frá töflu T1.

Kröfur til raflagna þar sem hleðsla rafknúinna farartækja fer fram er er að finna í drögum að staðli Alþjóða raftækniráðsins IEC 60364-7-722, Ed.1.0. sem verður hluti íslenska staðalsins ÍST 200, Raflagnir bygginga.

Í lögn að tengistað, þ.e. þeim stað sem rafbíll tengist raflögninni, tengill eða inntak á bíl, skal ekki vera PEN-leiðari. Sérhver tengistaður skal varinn með yfirstraumsvarnarbúnaði og bilunarstraumsrofa (lekastraumsrofa) með málbilunarstraum ekki hærrí en 30mA, sem eingöngu verja þennan tiltekna tengistað.

Hver tengistaður skal einungis fæða einn rafbíl.

Bilunarstraumsrofar skulu vera af gerð A, eða B, eftir því sem við á.

### SKÝRINGAR.

- 1 Aðaltafla
- 2 Sökkulskaut
- 3 Rafmagnsinntak PPø 50mm
- 4 2xø 25mm 1xø 32mm fyrir garðlýsingu og Rafbílahleðslu
- 6 Spennujöfnun heitt/kalt 1x10mm<sup>2</sup>
- 7 Tengill IP 44 í þakkant
- 8 1X6mm að T1
- 9 Sökkulskaut
- 10 Rafbílahleðsla
- 11 speglalýsing, h=210.
- 12 Rofadós með brunapól EI60

### SKÝRINGAR.

1XPPø50mm fyrir símainntak / ljósléiðara

Uppgefin hæð gildir, nema annað sé tekið fram

Hæð miðast við fullfrágengið gólf, í miðja dós

Lagnir f/lágspennu skulu vera 20mm

Ávallt skal leggja 20xCAT5e að tengistað

L : loftnetstengill h : 20

S : símatengill h : 20

H : hátalaratengill h : 20

 HITANEMI, h : 150.

 Að loftnetum 2x20mm



 2

 3 Dyrabjall h:2300 og hnappur h:1100



























 4 Að Smá spennuhólfi í T1













 5 Tengidós fyrir gólfhitakistu

 6 Nánara samráð við hönnuð gólfhita











 7 Að smáspennuhólfi  fyrir þráðlausan WIFI sendi

### Lágspenna



















-  Pípur ø16
-  Pípur í gólfi ø16
-  Strengur
-  Flatkapall
-  Snúrur
-  Sökkulskaut
-  Tengill hæð 200
-  Tengill hæð 1100
-  Einfaldur rofi í dós hæð 1100
-  Einfaldur rofi í dós hæð 800
-  Samrofi hæð 1100
-  Krossrofi hæð 1100
-  Tvöfaldir rofar í einni dós hæð 1100
-  Tveir einfaldir rofar hæð 1100
-  Þrýstidimmar 1x500W hæð 1100
-  2x210W þrýstidimmar í einni dós hæð 1100
-  2x500W þrýstidimmar í tveimur dósúm hæð 1100
-  Þrýstirofi, gefur merki til snertidimma hæð 1100
-  Hnappur hæð 1100
-  Rofi og tengill í tveim dósúm hæð 1100
-  Loftdós fyrir ljós
-  Veggdós fyrir ljós hæð 1800
-  Loftdós til tengingar
-  Veggdós til tengingar hæð 600
-  Gardínumótor
-  Útljós

-  Loftdós f. ljós með neyðarbúnaði
-  LED næturlyós
-  Hreyfiskynjari hæð 1100
-  Ljóssemi
-  Jarðbinding
-  Spennir
-  Pípur fara niður
-  Pípur fara upp
-  Pípur fara upp og niður.
-  Loftdós með spennuhólfi fyrir halogenljós
-  Loftdós fyrir halogenljós-ledljós skv. lampaplani
-  Loftdós fyrir halogenljós-ledljós
-  Hitanemi

### Instabus

-  Pípur
-  Pípur í gólfi
-  Flatkapall
-  GIRA snertiskynjari tvöfalldur með hitanema hæð 1300
-  GIRA snertiskynjari einfalldur nr. 1061 hæð 1300
-  GIRA snertiskynjari þrefalldur nr. 1063 hæð 1300
-  GIRA hreyfiskynjari hæð 2200 nr. 1305 hæð 1300
-  GIRA snertiskjór nr. 2071 hæð 1500
-  GIRA rofaliði á DIN skynnu, sjá nánar tengillista
-  GIRA dimmar á DIN skynnu, sjá nánar tengillista

### Smáspenna

-  Pípur ø20
-  Pípur í gólfi ø20
-  Smáspennudós hæð 200
-  Smáspennudós hæð 1100
-  Fjarskipti hæð 200
-  Loftnet hæð 200
-  Dyrasími hæð 1500
-  Hátalari hæð 1100
-  Hnappur hæð 1100
-  Loftdós til tengingar
-  Veggdós hæð 1500
-  Hurðanemi öryggiskerfis
-  Hnappaborð öryggiskerfis hæð 1500
-  Hreyfiskynjari öryggiskerfis
-  Hurðanemi
-  Lagnaleið, möguleiki á gardínustýringu
-  Hurðaopnun
-  Pípur fara niður
-  Pípur fara upp

## KIÐJABERG LÓÐ NR. 18 GRÍMSNES OG GRAFNINGSHREPPUR

### SKÝRINGAR

HANNAÐ.: GL/GL VERKNR.: 2022\_05\_03

TEIKNAB.: GL/GL TEIKNING NR.: R0

DAGS.: JAN2023 KVARÐI.:

BLAÐSTÆRÐ.: A 1

## G.LÁR RAF EHF

HÖNNUN OG RÁÐGJÖF  
HAFNARGÖTU 27A  
230 REYKJANESBÆR

SAMPYKKT:  
GUÐNI LÁRUSSON KT: 1 50373-3609

HÖNNUNARSTJÓRI:  
GUÐMUNDUR ÁRNI ÞÓRÐARSSON 1 20986-3769

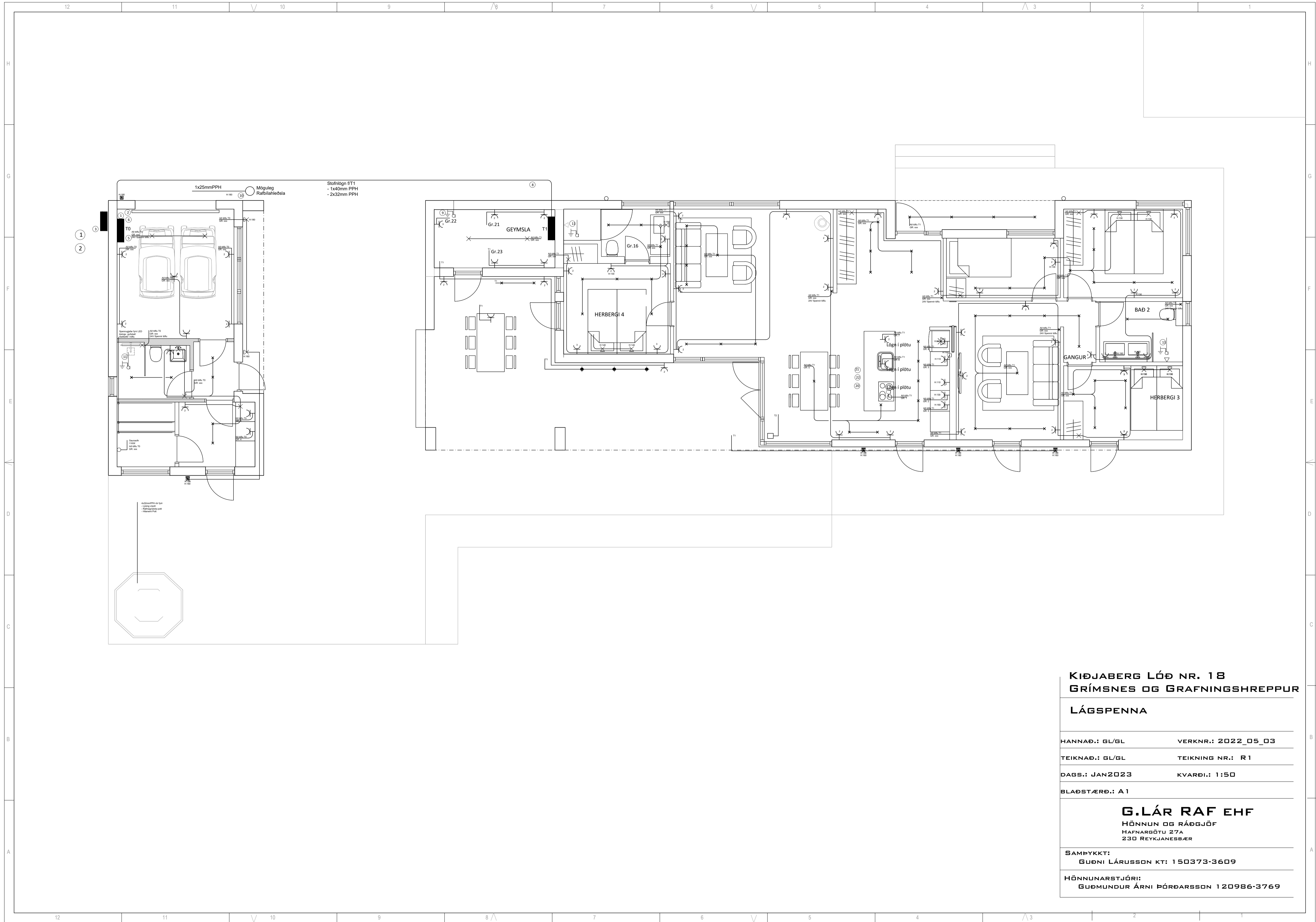

**KIÐJABERG LÓÐ NR. 18  
GRÍMSNES OG GRAFNINGSHREPPUR**

**LÁGSPENNA**

HANNAÐ: GL/GL	VERKNR.: 2022_05_03
TEIKNAD: GL/GL	TEIKNING NR.: R 1
DAGS.: JAN2023	KVARÐI.: 1:50
BLAÐSTÆRD.: A 1	

**G.LÁR RAF EHF**  
HÖNNUN OG RÁÐGJÖF  
HAFNARGÖTU 27A  
230 REYKJANESBÆR

SAMÞYKKT:  
GUÐNI LÁRUSSON KT: 150373-3609

HÖNNUNARSTJÓRI:  
GUÐMUNDUR ÁRNI ÞÓRÐARSSON 120986-3769

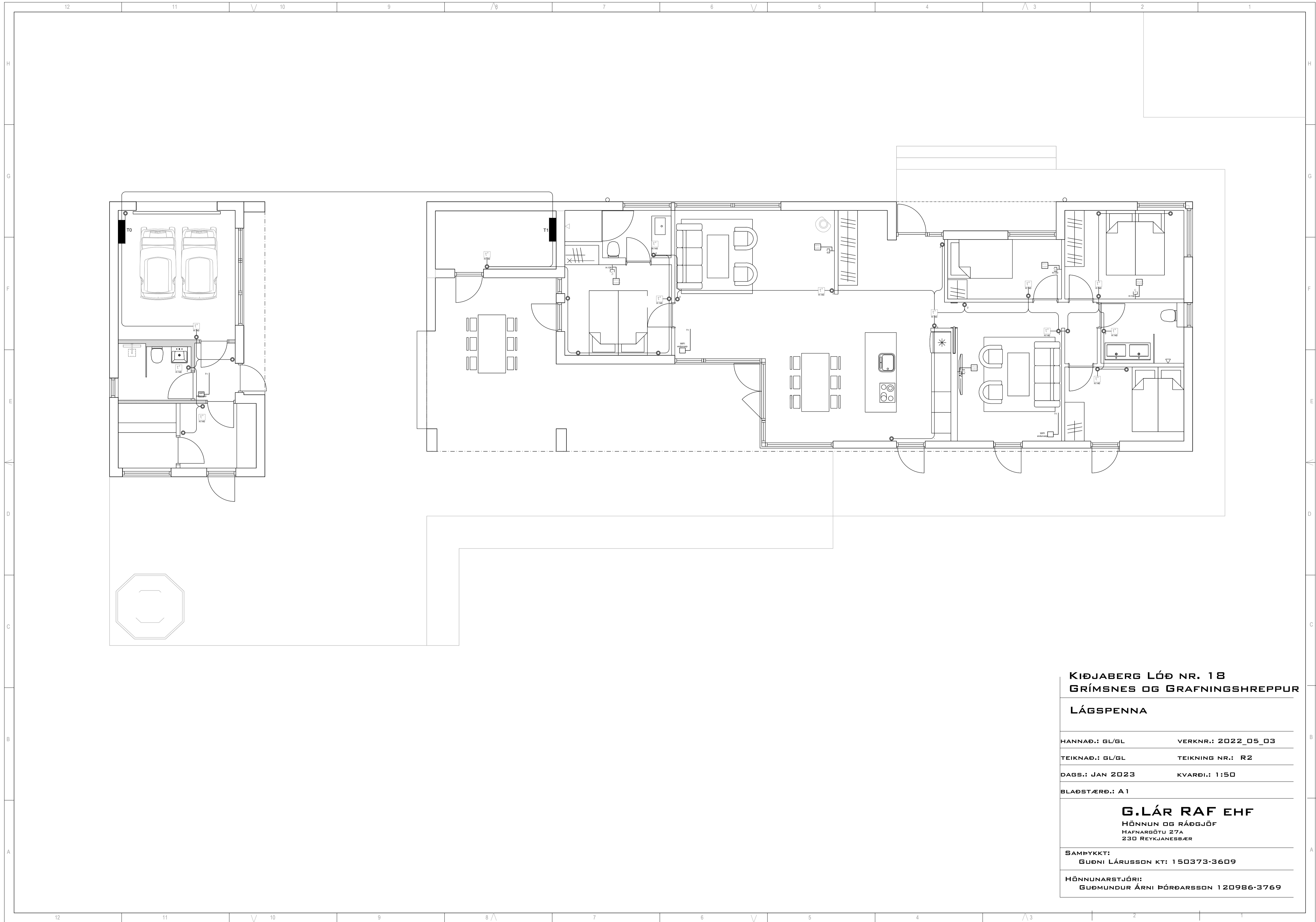

**KIÐJABERG LÓÐ NR. 18  
GRÍMSNES OG GRAFNINGSHREPPUR**

**LÁGSPENNA**

HANNAÐ: GL/GL                      VERKNR.: 2022\_05\_03  
TEIKNAÐ: GL/GL                      TEIKNING NR.: R2  
DAGS.: JAN 2023                      KVARÐI.: 1:50  
BLAÐSTÆRÐ.: A 1

**G.LÁR RAF EHF**  
HÖNNUN OG RÁÐGJÖF  
HAFNARGÖTU 27A  
230 REYKJANESBÆR

SAMÞYKKT:  
GUÐNI LÁRUSSON KT: 150373-3609

HÖNNUNARSTJÓRI:  
GUÐMUNDUR ÁRNI ÞÓRÐARSSON 120986-3769

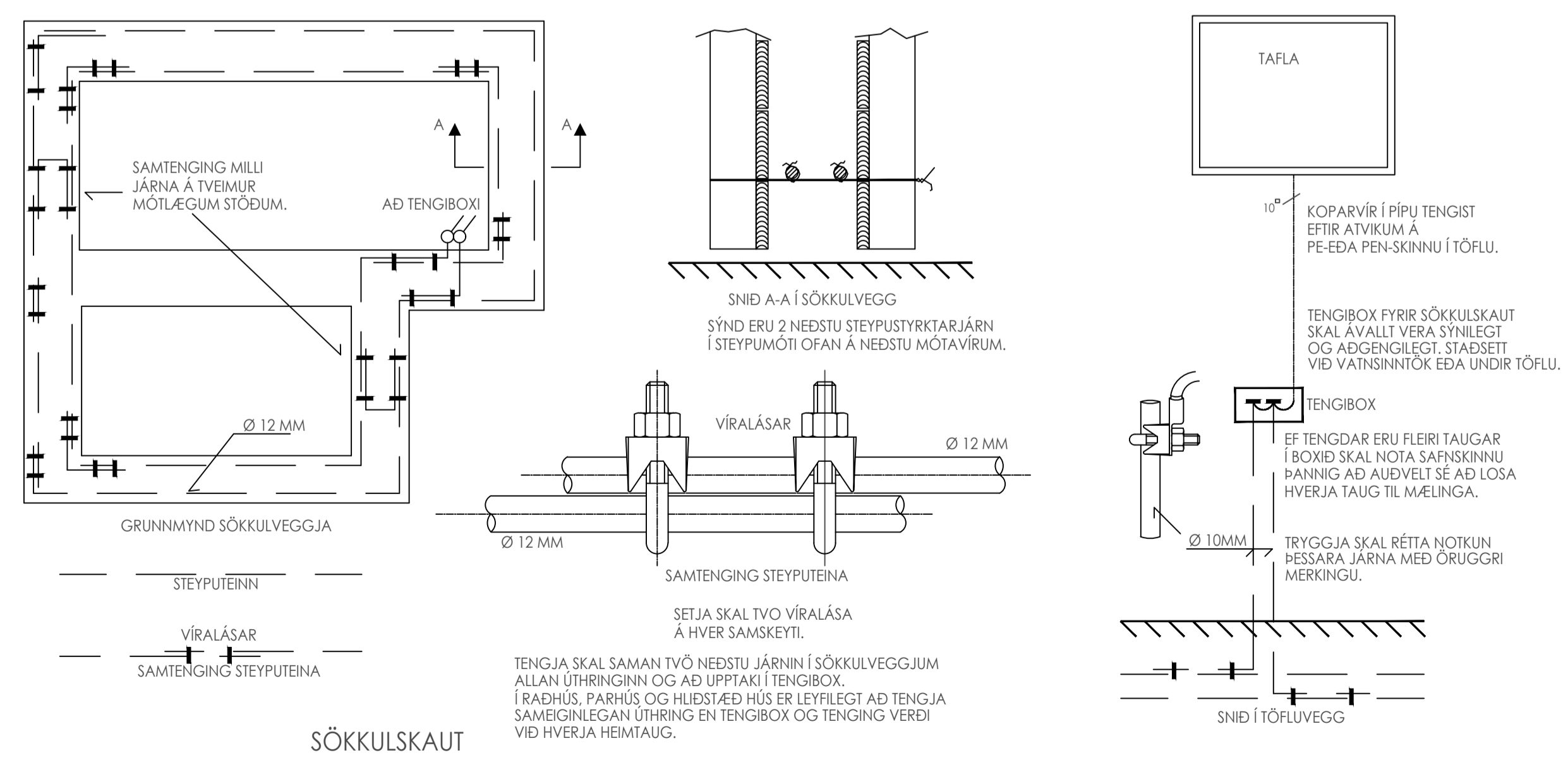
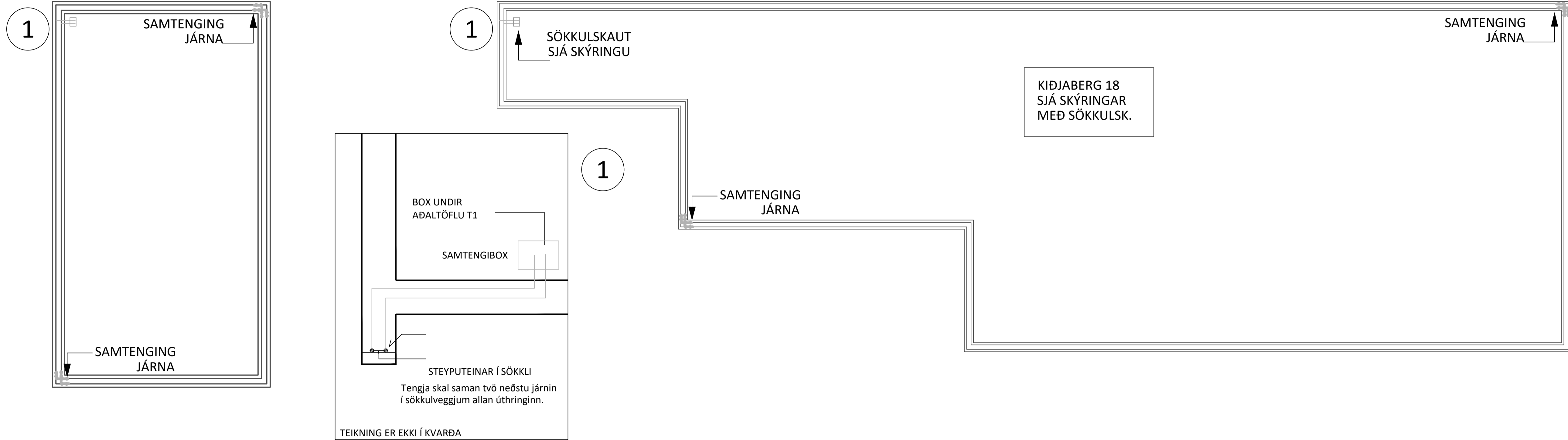

**KIDJABERG LÓÐ NR. 18**  
**GRÍMSNES OG GRAFNINGSHREPPUR**

**SÖKKULSKAUT**

HANNAÐ: GL/GL	VERKNR.: 2022_05_03
TEIKNAD: GL/GL	TEIKNING NR.: R3
DAGS.: JAN 2023	KVARÐI.:
BLAÐSTÆRÐ.: A1	

**G.LÁR RAF EHF**  
HÖNNUN OG RÁÐGJÖF  
HAFNARGÖTU 27A  
230 REYKJANESBÆR

SAMÞYKKT:  
GUÐNI LÁRUSSON KT: 150373-3609

HÖNNUNARSTJÓRI:  
GUÐMUNDUR ÁRNI ÞÓRÐARSSON 120986-3769

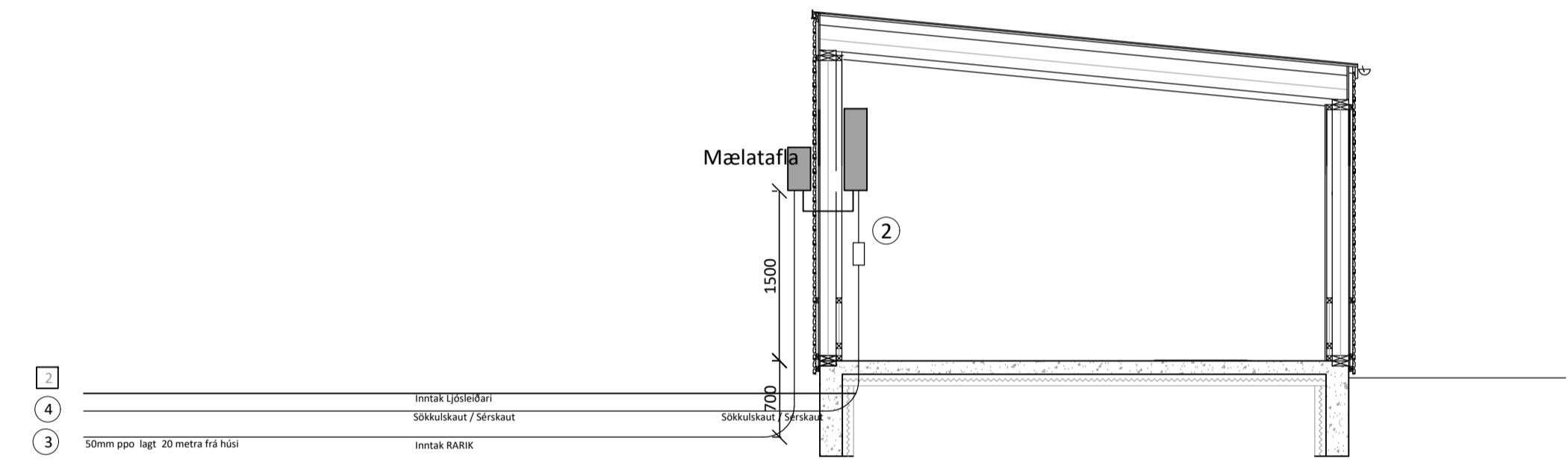
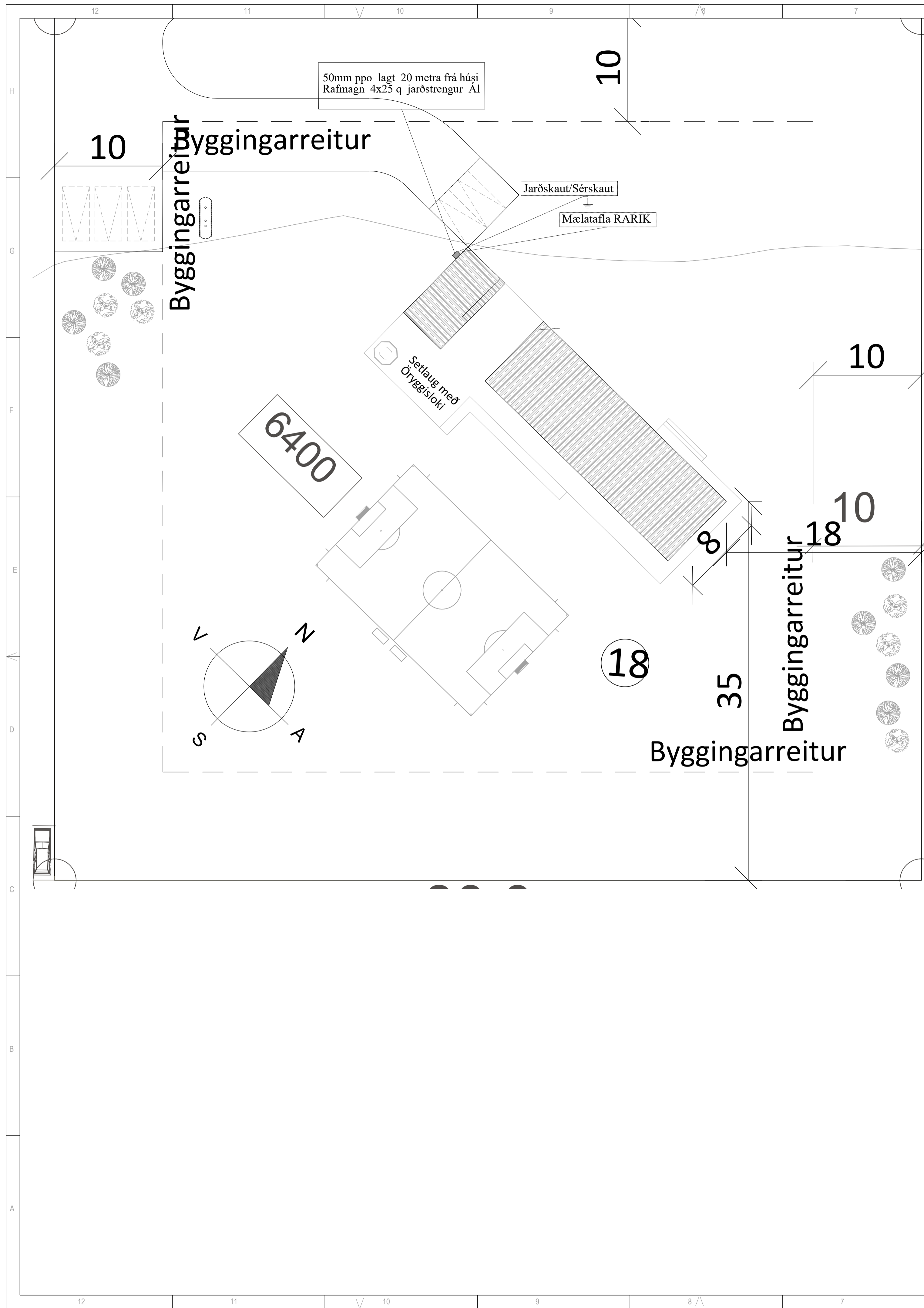

**KIÐJABERG LÓÐ NR. 18**  
**GRÍMSNES OG GRAFNINGSHREPPUR**

---

**AFSTAÐA OG SNIÐ**

---

HANNAÐ.: GL/GL                      VERKNR.: 2022\_05\_03

---

TEIKNAD.: GL/GL                      TEIKNING NR.: R3

---

DAGS.: JAN 2023                      KVARÐI.:

---

BLAÐSTÆRÐ.: A 1

---

**G.LÁR RAF EHF**  
 HÖNNUN OG RÁÐGJÖF  
 HAFNARGÖTU 27A  
 230 REYKJANESBÆR

---

SAMÞYKKT:  
 GUÐNI LÁRUSSON KT: 150373-3609

---

HÖNNUNARSTJÓRI:  
 GUÐMUNDUR ÁRNI ÞÓRÐARSSON 120986-3769

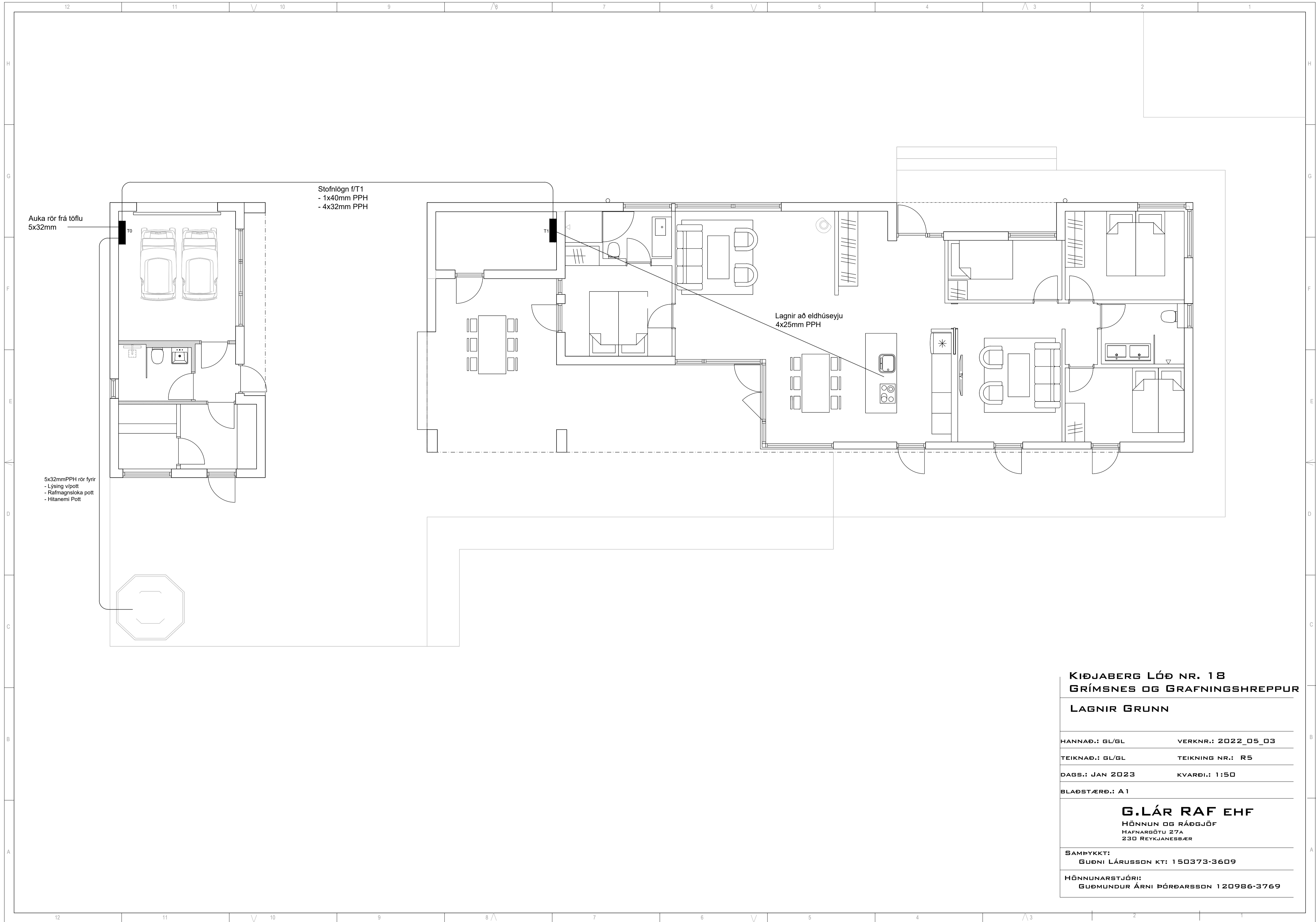

Auka rör frá töflu  
5x32mm

Stofnlögn f/T1  
- 1x40mm PPH  
- 4x32mm PPH

Lagnir að eldhúseyju  
4x25mm PPH

5x32mmPPH rör fyrir  
- Lýsing vípott  
- Rafmagnsloka pott  
- Hitanemi Pott

**KIÐJABERG LÓÐ NR. 18  
GRÍMSNES OG GRAFNINGSHREPPUR**

**LAGNIR GRUNN**

HANNAÐ.: GL/GL	VERKNR.: 2022_05_03
TEIKNAÐ.: GL/GL	TEIKNING NR.: R5
DAGS.: JAN 2023	KVARÐI.: 1:50
BLAÐSTÆRÐ.: A 1	

**G.LÁR RAF EHF**  
HÖNNUN OG RÁÐGJÖF  
HAFNARGÖTU 27A  
230 REYKJANESBÆR

SAMÞYKKT:  
GUÐNI LÁRUSSON KT: 150373-3609

HÖNNUNARSTJÓRI:  
GUÐMUNDUR ÁRNI ÞÓRÐARSSON 120986-3769

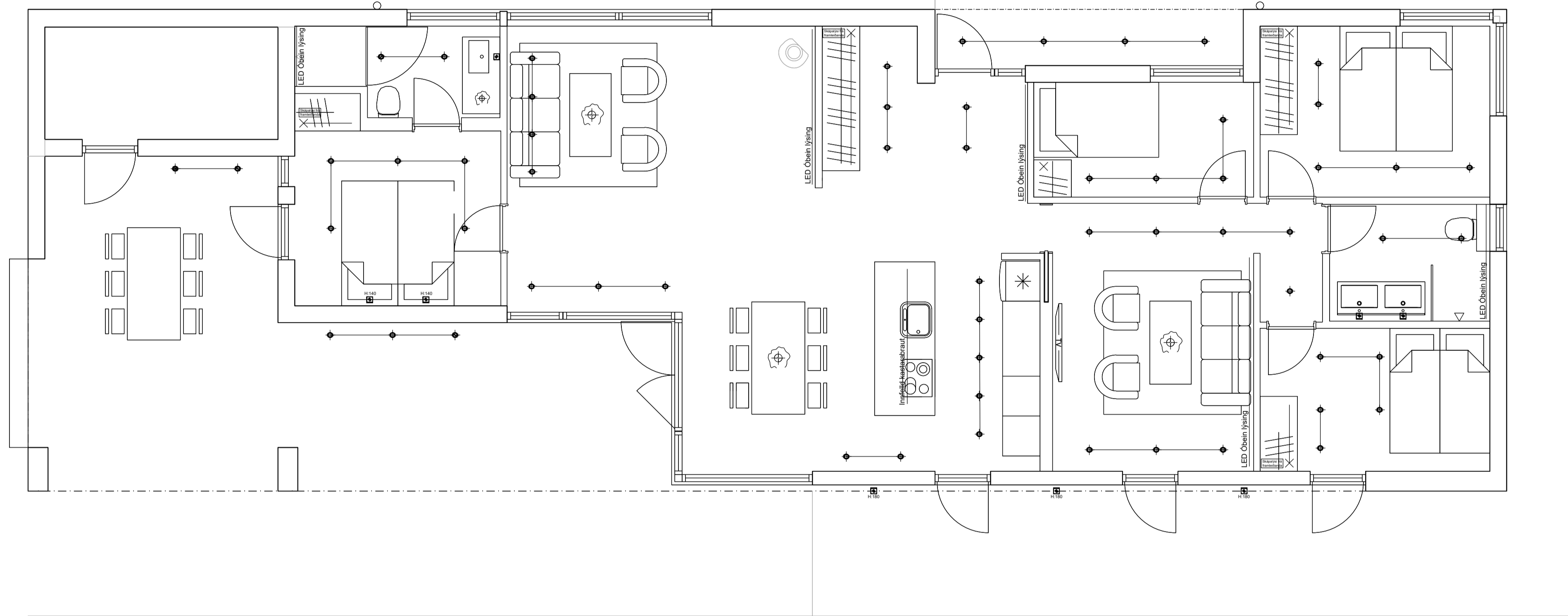
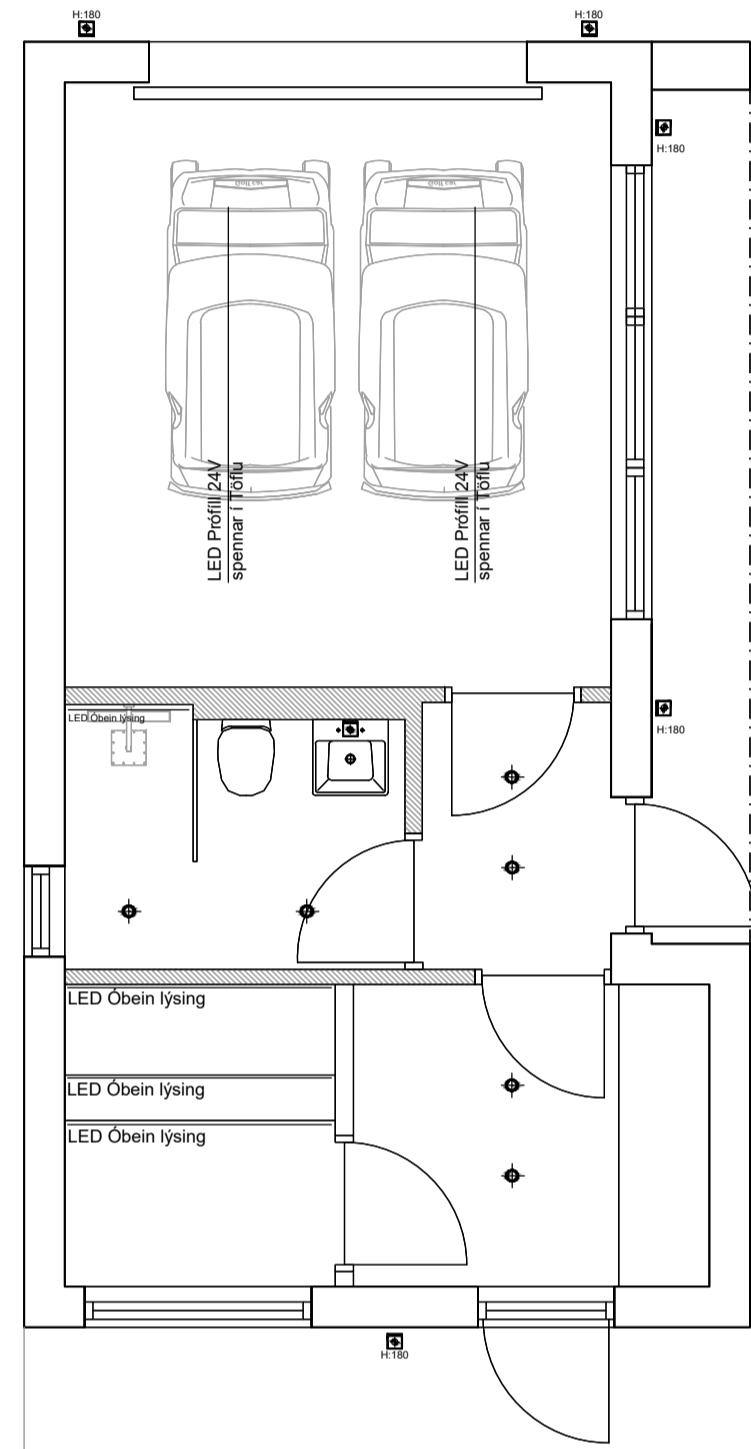

**KIÐJABERG LÓÐ NR. 18  
GRÍMSNES OG GRAFNINGSHREPPUR**

**LJÓSAPLAN**

HANNAÐ: GL/GL VERKNR.: 2022\_05\_03

TEIKNAD: GL/GL TEIKNING NR.: R6

DAGS.: JAN 2023 KVARÐI.: 1:50

BLAÐSTÆRÐ.: A 1

**G.LÁR RAF EHF**  
HÖNNUN OG RÁÐGJÖF  
HAFNARGÖTU 27A  
230 REYKJANESBÆR

SAMÞYKKT:  
GUÐNI LÁRUSSON KT: 150373-3609

HÖNNUNARSTJÓRI:  
GUÐMUNDUR ÁRNI ÞÓRÐARSSON 120986-3769



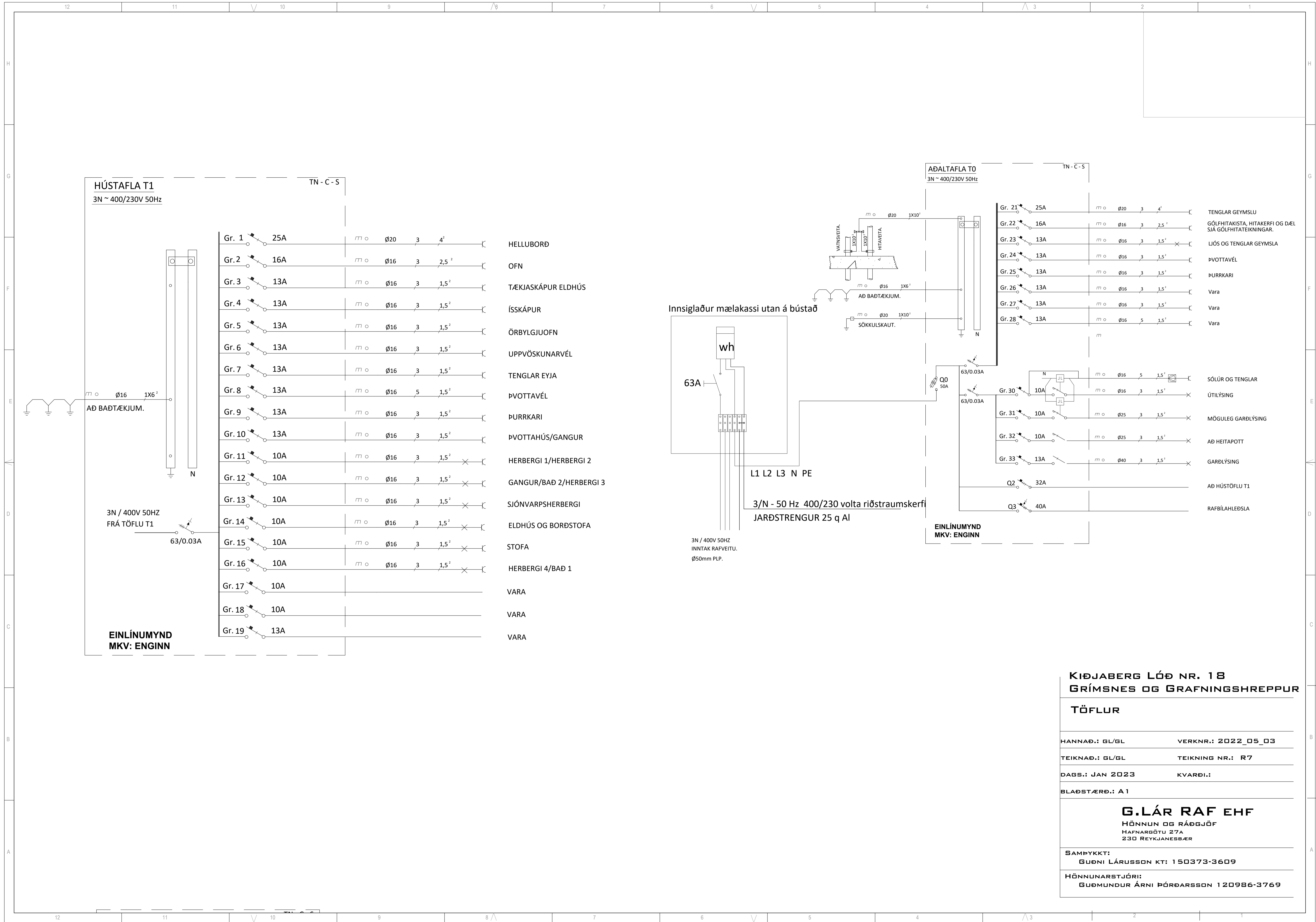

**KIÐJABERG LÓÐ NR. 18  
GRÍMSNES OG GRAFNINGSHREPPUR**

**TÖFLUR**

HANNAÐ.: GL/GL	VERKNR.: 2022_05_03
TEIKNAD.: GL/GL	TEIKNING NR.: R7
DAGS.: JAN 2023	KVARÐI.:
BLAÐSTÆRD.: A 1	

**G.LÁR RAF EHF**  
HÖNNUN OG RÁÐGJÖF  
HAFNARGÖTU 27A  
230 REYKJANESBÆR

SAMÞYKKT:  
GUÐNI LÁRUSSON KT: 150373-3609

HÖNNUNARSTJÓRI:  
GUÐMUNDUR ÁRNI ÞÓRÐARSSON 120986-3769