

Hölzl & Rebernig ZT GmbH

Ziviltechnikergesellschaft für Bauingenieurwesen

Hernalser Hauptstraße 35/14, 1170 Wien

office@hr-zt.at | www.hr-zt.at

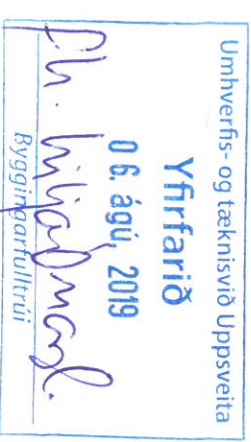

Summerhouse

Structure – KLH solid wood panels and steel construction

Details of Joints

Client:	Element ehf. Skólavörðustígur 12 101 Reykjavík Iceland
Project Number:	2018-088
Document Number:	103
Current Revision:	2.0

Vienna, May 20th 2019

Overview documents

Document	Document Number
	Summerhouse
Basis of Design (BOD) and structure	101
Annex 1 - Structure	101
Annex 2 -Loads	101
Annex 3 - Forces on concrete structure	101
Overview details	102
Details of joints	103

2nd FLOOR

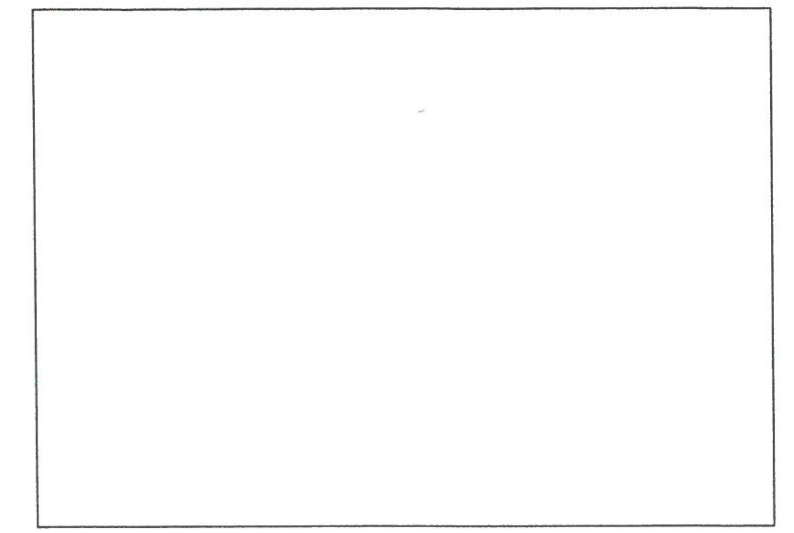
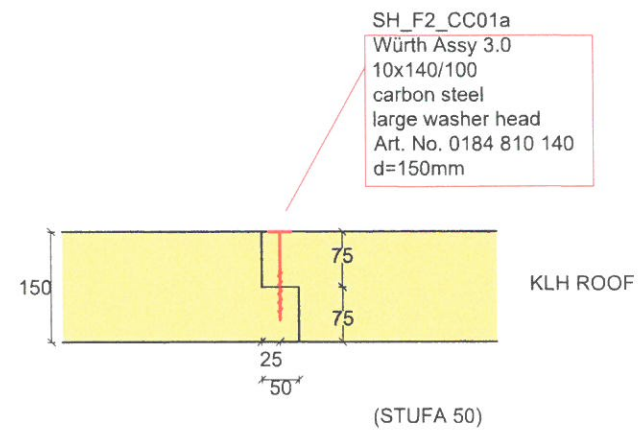

scale 1 : 10

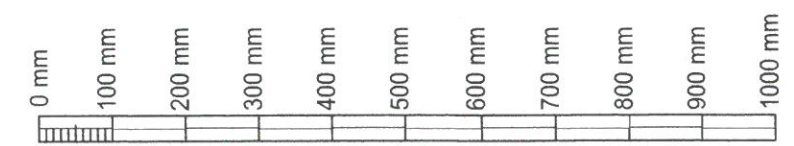

ÚTGÁFA | SKÝRING | DAGS. | HANN. | YFIRF. | SAMP.

DAGS. UNDIRSKRIFTAR | BURDARPOLSHÖNNUDUR - SIGURÐUR UNNAR SIGURÐSSON KT. 290772-4279
 20.6.19 | Sig U. Sig

DAGS. UNDIRSKRIFTAR | NAFN OG KENNITALA SAMRÆMINGARHÖNNUDAR
 20.6.19 | Sig U. Sig

HÖNNUDUR
 **KLH Massivholz GmbH**
 Gewerbestraße 4
 A-8842 Teufenbach-Katsch
 Tel. +43 (0) 3588/8835 - 0
 Fax +43 (0) 3588/8835 - 20
 E-Mail: office@klh.at

HEITI VERKS
FLATIR LÓÐ 9 - L208461
SKEIÐA- OG GNÚPVERJAHREPPI
FRÍSTUNDAHÚS

HEITI TEIKNINGAR
 Ceiling - Ceiling

VERKNÚMÉR 2018 - 088 | DAGS. 13.05.2019 | NR. TEIKNINGAR D01

BLAÐSTÆRÐ: DIN A3

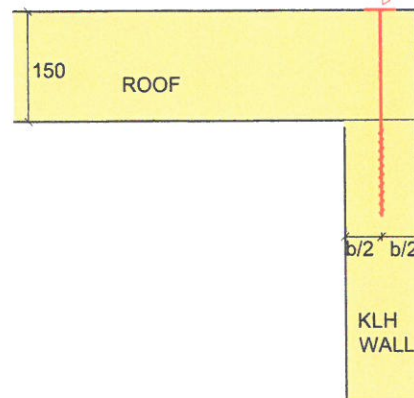

SH_F2_CW01a
 Würth Assy 3.0
 10x260/100
 carbon steel
 large washer head
 Art. No. 0184 810 260
 d= 100 mm

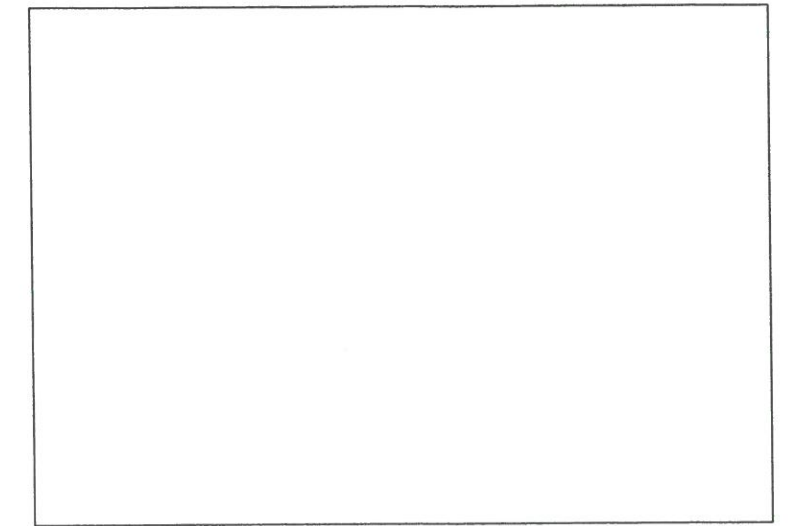

scale 1 : 10

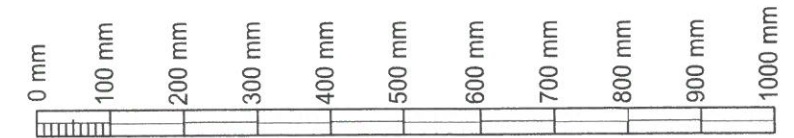

ÚTGÁFA		SKÝRING		DAGS.	HANN.	YFIRF.	SAMP.
DAGS. UNDIRSKRIFTAR		BURÐARPOLSHÖNNUÐUR - SIGURÐUR UNNAR SIGURÐSSON KT. 290772-4279					
20.6.19		Sig U. Sig					
DAGS. UNDIRSKRIFTAR		NAFN OG KENNITALA SAMRÆMINGARHÖNNUÐAR					
20.6.19		Sig U. Sig					
HÖNNUÐUR		 KLH Massivholz GmbH Gewerbestraße 4 A-8842 Teufenbach-Katsch Tel. +43 (0) 3588/8835 - 0 Fax +43 (0) 3588/8835 - 20 E-Mail: office@klh.at					
HEITI VERKS		FLATIR LÓÐ 9 - L208461 SKEIÐA- OG GNÚPVERJAHREPPI FRÍSTUNDAHÚS					
HEITI TEIKNINGAR		Ceiling - Wall					
VERKNÚMÉR		2018 - 088		DAGS.		13.05.2019	
				NR. TEIKNINGAR		D02	

BLADSTÆRÐ: DIN A3

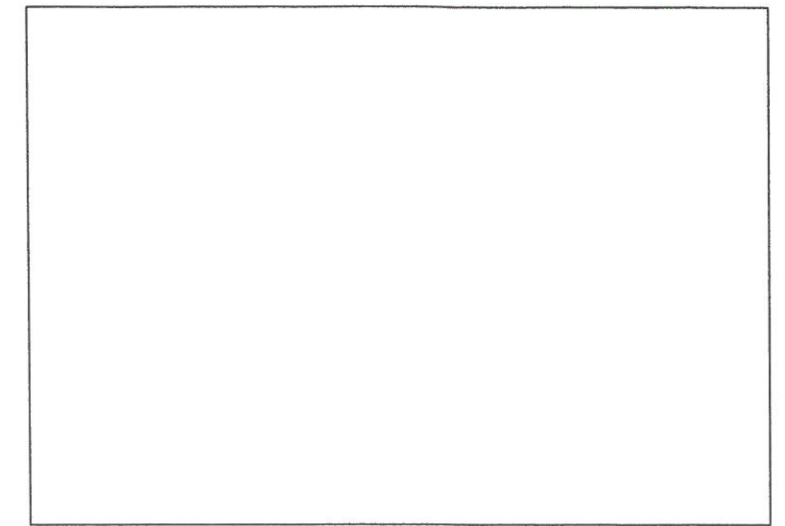
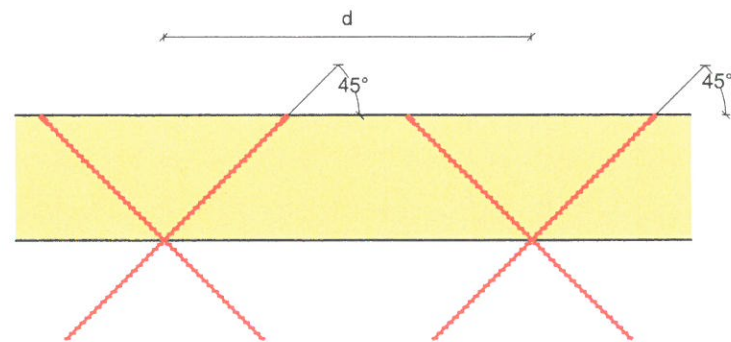
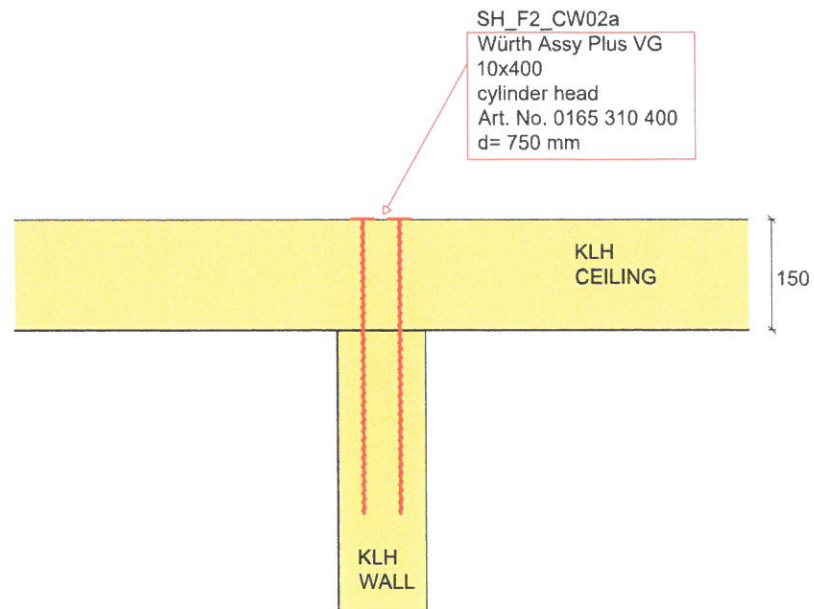

scale 1 : 10

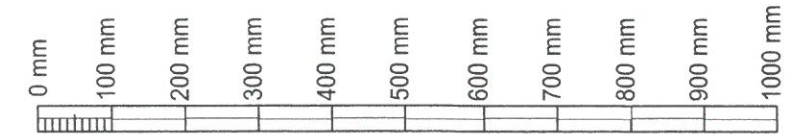

ÚTGÁFA | SKÝRING | DAGS. | HANN. | YFIRF. | SAMÞ.

DAGS. UNDIRSKRIFTAR | BURÐARPOLSHÖNNUDUR - SIGURÐUR UNNAR SIGURÐSSON KT. 290772-4279
 20.6.19 | Sig U. Sig

DAGS. UNDIRSKRIFTAR | NAFN OG KENNITALA SAMRÆMINGARHÖNNUDAR
 20.6.19 | Sig U. Sig

HÖNNUDUR |  **KLH Massivholz GmbH**
 Gewerbestraße 4
 A-8842 Teufenbach-Katsch
 Tel. +43 (0) 3588/8835 - 0
 Fax +43 (0) 3588/8835 - 20
 E-Mail: office@klh.at

HEITI VERKS
FLATIR LÓÐ 9 - L208461
SKEIÐA- OG GNÚPVERJAHREPPI
FRÍSTUNDAHÚS

HEITI TEIKNINGAR
 Ceiling - Wall

VERKNÚMÉR 2018 - 088 | DAGS. 13.05.2019 | NR. TEIKNINGAR D03

BLADSTÆRÐ: DIN A3

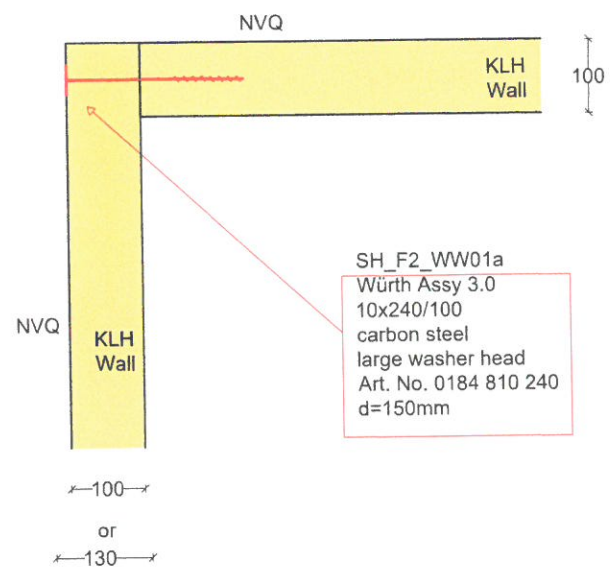

scale 1 : 10

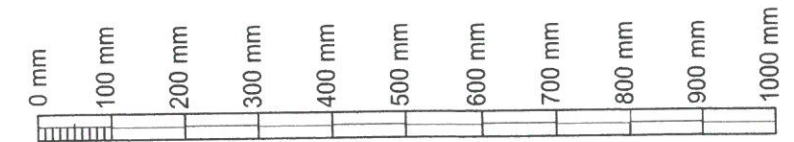

DAGS. UNDIRSKRIFTAR		BURÐARPOLSHÖNNUÐUR - SIGURÐUR UNNAR SIGURÐSSON KT. 290772-4279	
20.6.19		Sig U. Sig	
DAGS. UNDIRSKRIFTAR		NAFN OG KENNITALA SAMRÆMINGARHÖNNUÐAR	
20.6.19		Sig U. Sig	
HÖNNUÐUR		KLH Massivholz GmbH Gewerbestraße 4 A-8842 Teufenbach-Katsch Tel. +43 (0) 3588/8835 - 0 Fax +43 (0) 3588/8835 - 20 E-Mail: office@klh.at	
HEITI VERKS			
FLATIR LÓÐ 9 - L208461 SKEIÐA- OG GNÚPVERJAHREPPI FRÍSTUNDAHÚS			
HEITI TEIKNINGAR			
Wall - Wall			
VERKNÚMÉR	2018 - 088	DAGS.	13.05.2019
		NR. TEIKNINGAR	D04

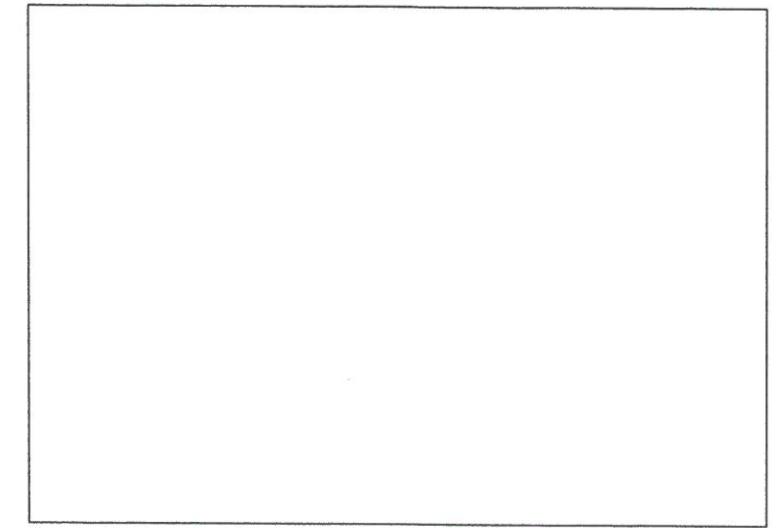
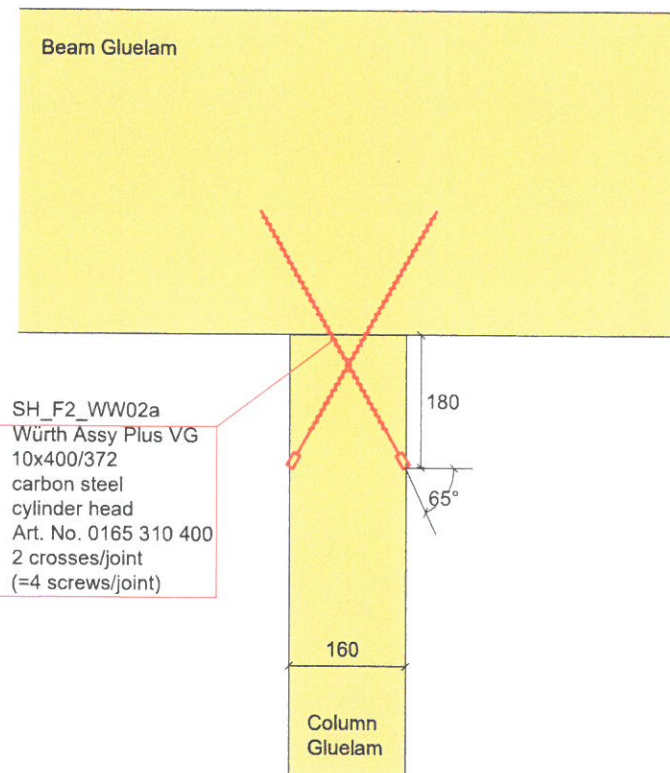

scale 1 : 10

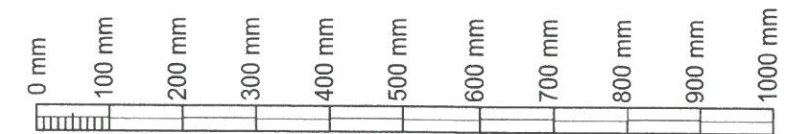

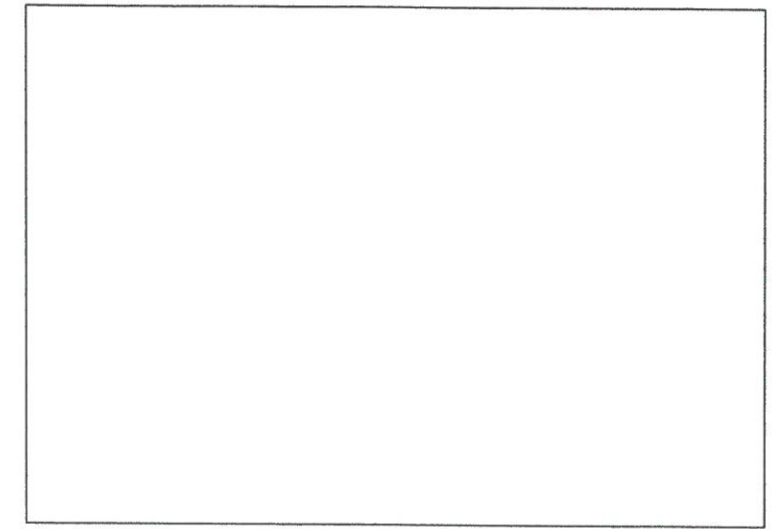
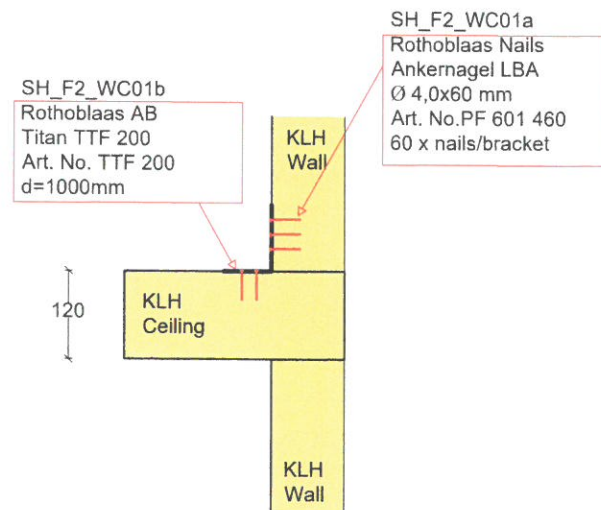

ÚTGÁFA SKÝRING		DAGS.	HANN.	YFIRF.	SAMB.
DAGS. UNDIRSKRIFTAR	BURÐARPOLSHÖNNUÐUR - SIGURÐUR UNNAR SIGURÐSSON KT. 290772-4279				
20.6.19	Sig U. Sig				
DAGS. UNDIRSKRIFTAR	NAFN OG KENNITALA SAMRÆMINGARHÖNNUÐAR				
20.6.19	Sig U. Sig				
HÖNNUÐUR	 KLH Massivholz GmbH Gewerbestraße 4 A-8842 Teufenbach-Katsch Tel. +43 (0) 3588/8835 - 0 Fax +43 (0) 3588/8835 - 20 E-Mail: office@klh.at				
HEITI VERKS	FLATIR LÓÐ 9 - L208461 SKEIÐA- OG GNÚPVERJAHREPPI FRÍSTUNDAHÚS				
HEITI TEIKNINGAR	Wall - Wall				
VERKNÚMÉR	2018 - 088	DAGS.	13.05.2019	NR. TEIKNINGAR	D05

BLADSTÆRÐ: DIN A3

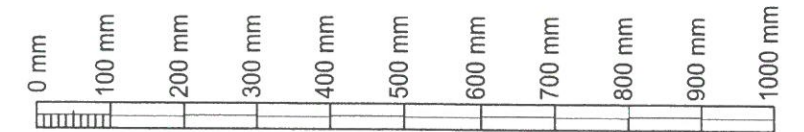

scale 1 : 10



ÚTGÁFA SKÝRING		DAGS.	HANN.	YFIRF.	SAMP.
DAGS. UNDIRSKRIFTAR	BURDARPOLSHÖNNUDUR - SIGURÐUR UNNAR SIGURÐSSON KT. 290772-4279				
20.6.19	Sig U. Sig				
DAGS. UNDIRSKRIFTAR	NAFN OG KENNITALA SAMRÆMINGARHÖNNUDAR				
20.6.19	Sig U. Sig				
HÖNNUDUR	 KLH Massivholz GmbH Gewerbestraße 4 A-8842 Teufenbach-Katsch Tel. +43 (0) 3588/8835 - 0 Fax +43 (0) 3588/8835 - 20 E-Mail: office@klh.at				
HEITI VERKS	FLATIR LÓÐ 9 - L208461 SKEIÐA- OG GNÚPVERJAHREPPI FRÍSTUNDAHÚS				
HEITI TEIKNINGAR	Wall - Ceiling				
VERKNÚMER	2018 - 088	DAGS.	13.05.2019	NR. TEIKNINGAR	D06

BLADSTÆRÐ: DIN A3

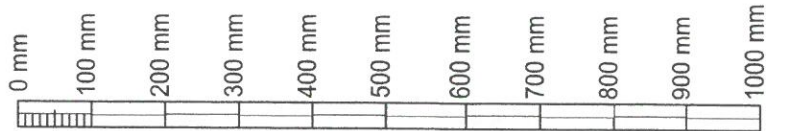
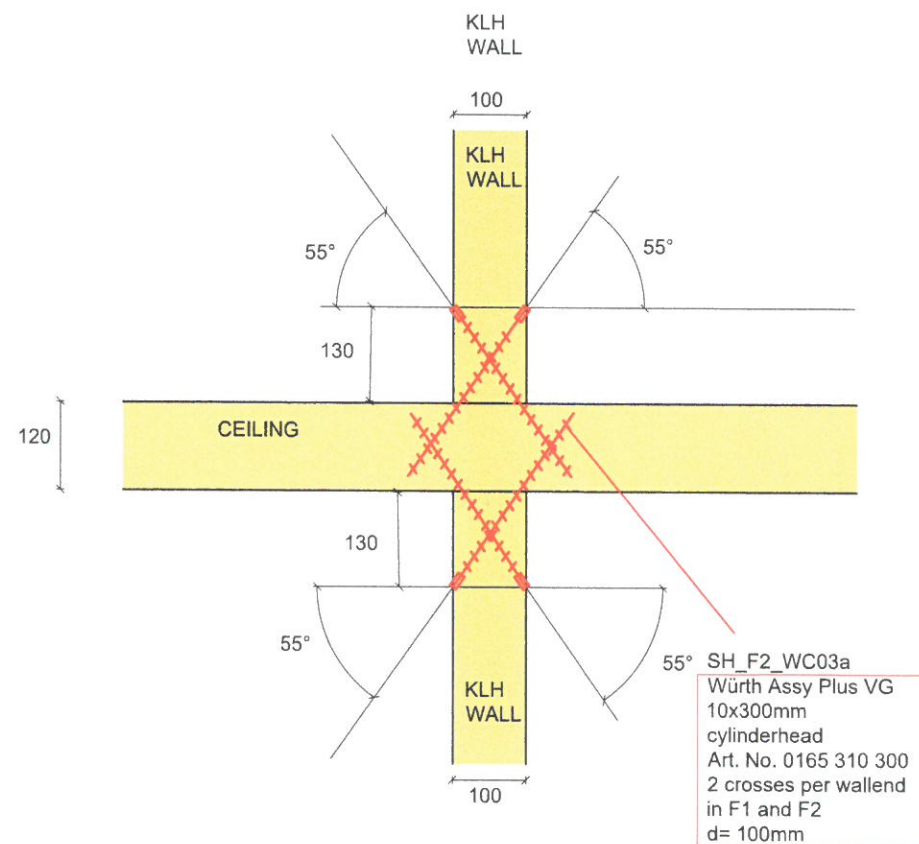

scale 1 : 10

DAGS. UNDIRSKRIFTAR		BURDARPOLSHÖNNUÐUR - SIGURÐUR UNNAR SIGURÐSSON KT. 290772-4279	
20.6.19		Sig U. Sig	
DAGS. UNDIRSKRIFTAR		NAFN OG KENNITALA SAMRÆMINGARHÖNNUÐAR	
20.6.19		Sig U. Sig	
HÖNNUÐUR		 KLH Massivholz GmbH Gewerbestraße 4 A-8842 Teufenbach-Katsch Tel. +43 (0) 3588/8835 - 0 Fax +43 (0) 3588/8835 - 20 E-Mail: office@klh.at	
HEITI VERKS			
FLATIR LÓÐ 9 - L208461 SKEIÐA- OG GNÚPVERJAHREPPI FRÍSTUNDAHÚS			
HEITI TEIKNINGAR			
Wall - Ceiling			
VERKNÚMÉR		DAGS.	
2018 - 088		13.05.2019	
		NR. TEIKNINGAR	
		D08	

1st FLOOR

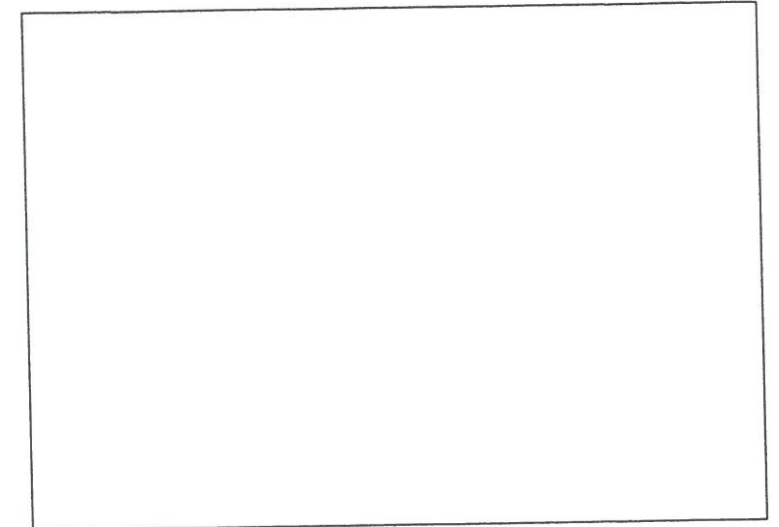
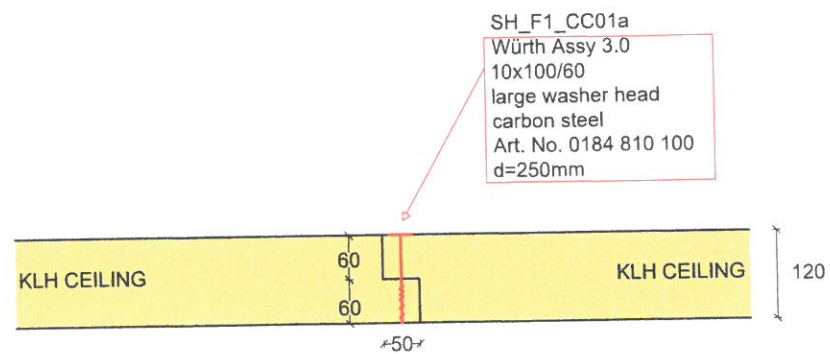

scale 1 : 10

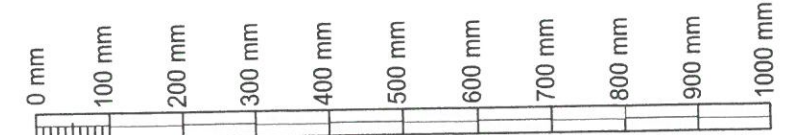

DAGS. UNDIRSKRIFTAR		BURÐARPOLSHÖNNUÐUR - SIGURÐUR UNNAR SIGURÐSSON KT. 290772-4279	
20.6.19		Sig U. Sig	
DAGS. UNDIRSKRIFTAR		NAFN OG KENNITALA SAMRÆMINGARHÖNNUÐAR	
20.6.19		Sig U. Sig	
HÖNNUÐUR		 KLH Massivholz GmbH Gewerbestraße 4 A-8842 Teufenbach-Katsch Tel. +43 (0) 3588/8835 - 0 Fax +43 (0) 3588/8835 - 20 E-Mail: office@klh.at	
HEITI VERKS		FLATIR LÓÐ 9 - L208461 SKEIÐA- OG GNÚPVERJAHREPPI FRÍSTUNDAHÚS	
HEITI TEIKNINGAR		Ceiling - Ceiling	
VERKNÚMÉR	2018 - 088	DAGS.	13.05.2019
		NR. TEIKNINGAR	D09

BLADSTÆRÐ: DIN A3

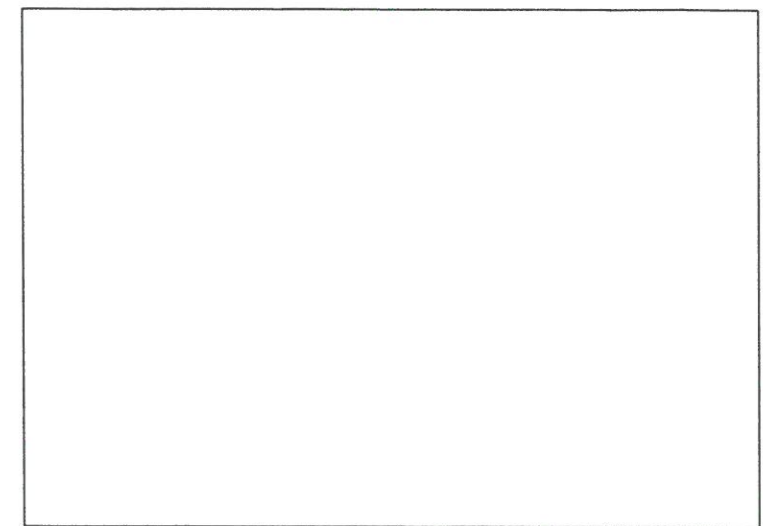
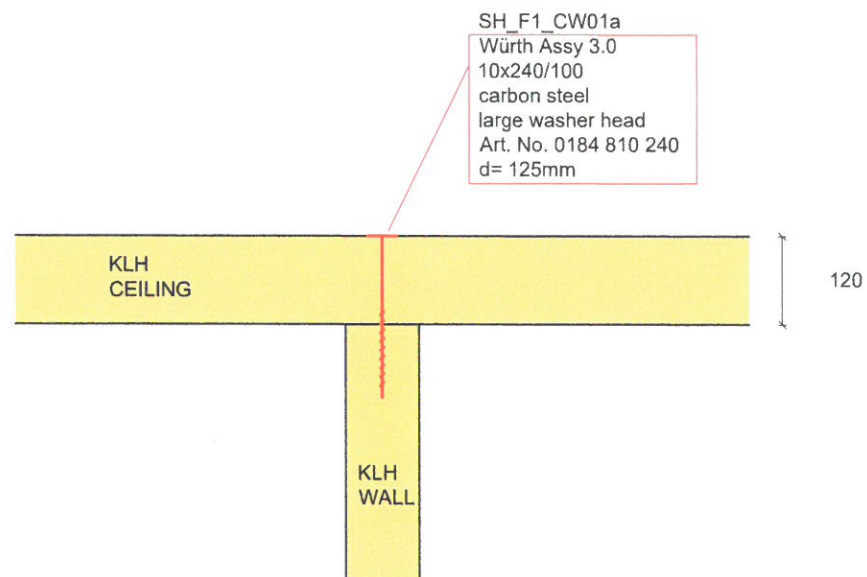

scale 1 : 10

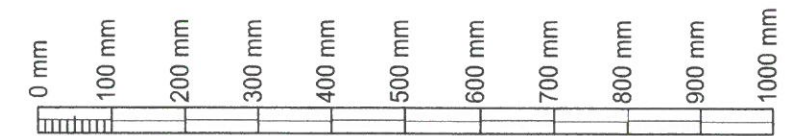

ÚTGÁFA | SKÝRING | DAGS. | HANN. | YFIRF. | SAMP.

DAGS. UNDIRSKRIFTAR

BURÐARPOLSHÖNNUÐUR - SIGURÐUR UNNAR SIGURÐSSON KT. 290772-4279

20.9.19

Sig U. Sig

DAGS. UNDIRSKRIFTAR

NAFN OG KENNITALA SAMRÆMINGARHÖNNUÐAR

20.9.19

Sig U. Sig

HÖNNUÐUR



KLH Massivholz GmbH

Gewerbestraße 4
A-8842 Teufenbach-Katsch
Tel. +43 (0) 3588/8835 - 0
Fax +43 (0) 3588/8835 - 20
E-Mail: office@klh.at

HEITI VERKS

**FLATIR LÓÐ 9 - L208461
SKEIÐA- OG GNÚPVERJAHREPPI
FRÍSTUNDAHÚS**

HEITI TEIKNINGAR

Ceiling - Wall

VERKNÚMÉR

2018 - 088

DAGS.

13.05.2019

NR. TEIKNINGAR

D10

BLADSTÆRÐ: DIN A3

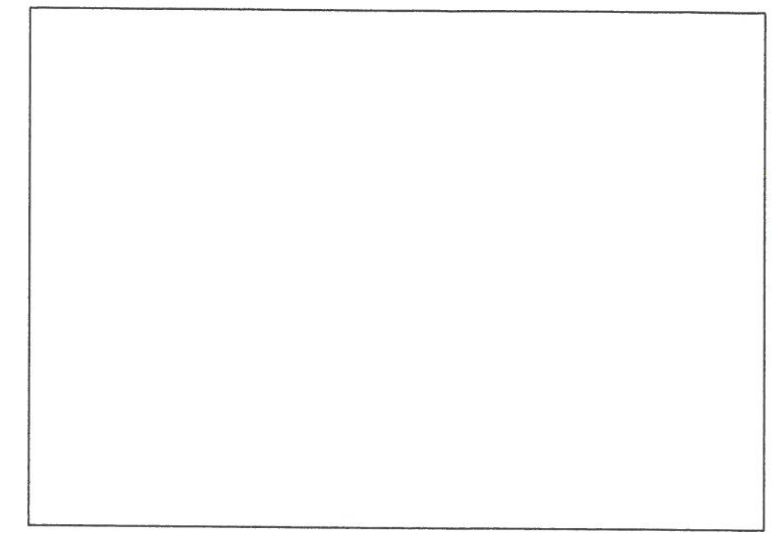
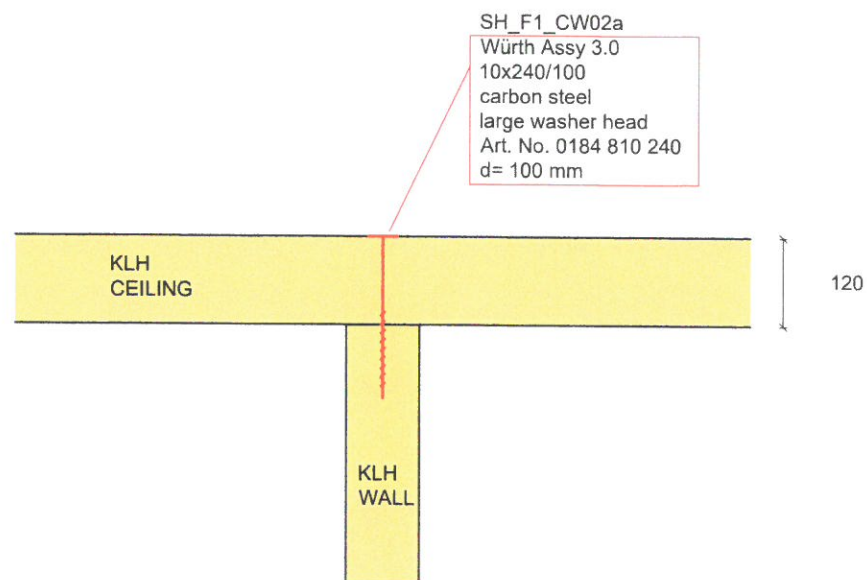

scale 1 : 10

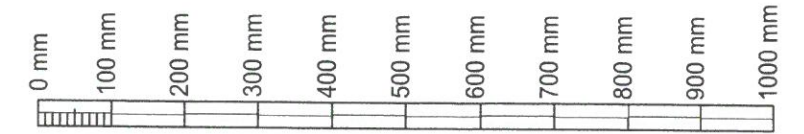

ÚTGÁFA | SKÝRING | DAGS. | HANN. | YFIRF. | SAMÞ.

DAGS. UNDIRSKRIFTAR | BURÐARPOLSHÖNNUÐUR - SIGURÐUR UNNAR SIGURÐSSON KT. 290772-4279
 20.6.19 | *Sig U. Sig*

DAGS. UNDIRSKRIFTAR | NAFN OG KENNITALA SAMRÆMINGARHÖNNUÐAR
 20.6.19 | *Sig U. Sig*

HÖNNUÐUR |  **KLH Massivholz GmbH**
 Gewerbestraße 4
 A-8842 Teufenbach-Katsch
 Tel. +43 (0) 3588/8835 - 0
 Fax +43 (0) 3588/8835 - 20
 E-Mail: office@klh.at

HEITI VERKS
FLATIR LÓÐ 9 - L208461
SKEIÐA- OG GNÚPVERJAHREPPI
FRÍSTUNDAHÚS

HEITI TEIKNINGAR
 Ceiling - Wall

VERKNÚMÉR | 2018 - 088 | DAGS. 13.05.2019 | NR. TEIKNINGAR | D11

BLADSTÆRD: DIN A3

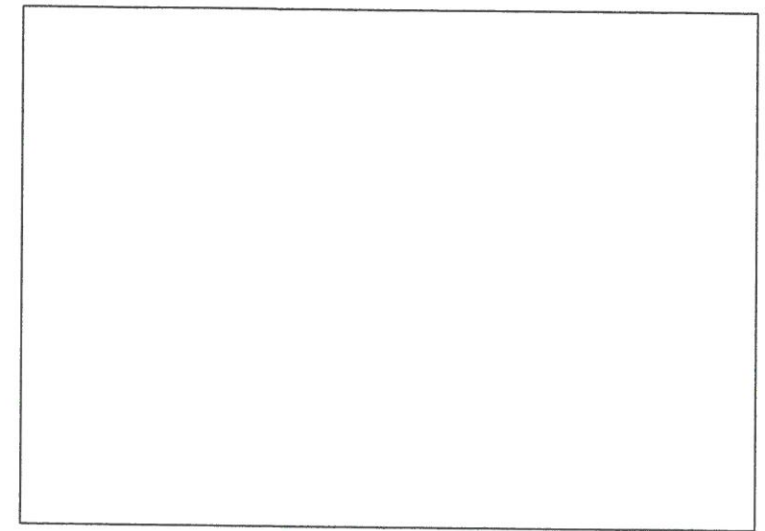
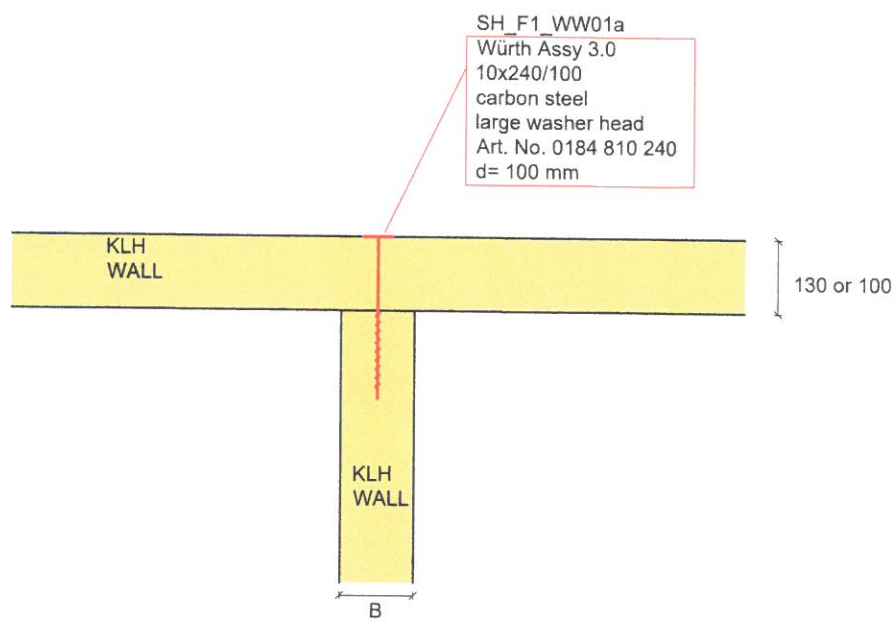

scale 1 : 10

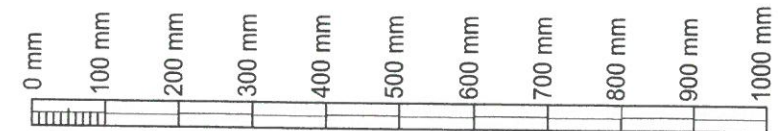

DAGS. UNDIRSKRIFTAR		BURÐARPOLSHÖNNUÐUR - SIGURÐUR UNNAR SIGURÐSSON KT. 290772-4279	
20.6.19		Sig U Sig	
DAGS. UNDIRSKRIFTAR		NAFN OG KENNITALA SAMRÆMINGARHÖNNUÐAR	
20.6.19		Sig U. Sig	
HÖNNUÐUR		KLH Massivholz GmbH Gewerbestraße 4 A-8842 Teufenbach-Katsch Tel. +43 (0) 3588/8835 - 0 Fax +43 (0) 3588/8835 - 20 E-Mail: office@klh.at	
HEITI VERKS			
FLATIR LÓÐ 9 - L208461 SKEIÐA- OG GNÚPVERJAHREPPI FRÍSTUNDAHÚS			
HEITI TEIKNINGAR			
Wall - Wall			
VERKNÚMÉR	2018 - 088	DAGS.	13.05.2019 NR. TEIKNINGAR
			D12

BLADSTÆRÐ: DIN A3

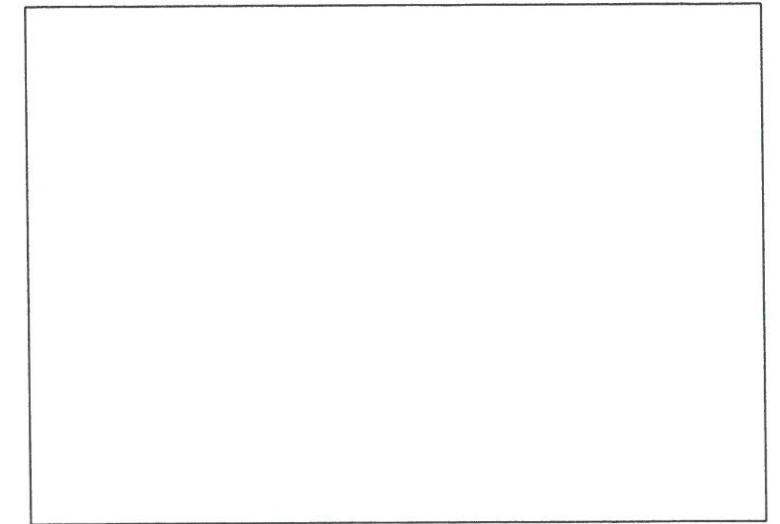
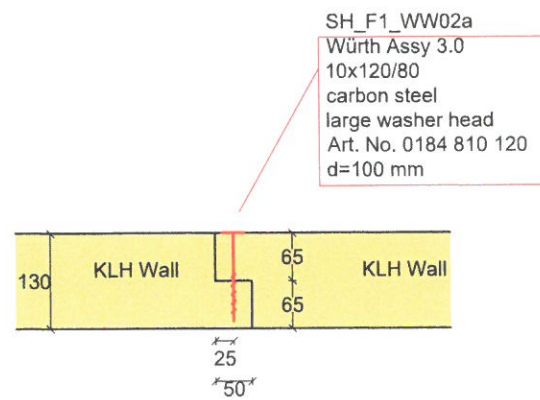

scale 1 : 10

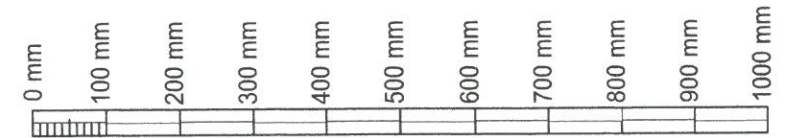

DAGS. UNDIRSKRIFTAR		BURÐARPOLSHÖNNUÐUR - SIGURÐUR UNNAR SIGURÐSSON KT. 290772-4279	
20.6.19		Sig U. Sig	
DAGS. UNDIRSKRIFTAR		NAFN OG KENNITALA SAMRÆMINGARHÖNNUÐAR	
20.6.19		Sig U. Sig	
HÖNNUÐUR		 KLH Massivholz GmbH Gewerbestraße 4 A-8842 Teufenbach-Katsch Tel. +43 (0) 3588/8835 - 0 Fax +43 (0) 3588/8835 - 20 E-Mail: office@klh.at	
HEITI VERKS			
FLATIR LÓÐ 9 - L208461 SKEIÐA- OG GNÚPVERJAHREPPI FRÍSTUNDAHÚS			
HEITI TEIKNINGAR			
Wall - Wall			
VERKNÚMÉR	2018 - 088	DAGS.	13.05.2019 NR. TEIKNINGAR
			D13

BLADSTÆRÐ: DIN A3

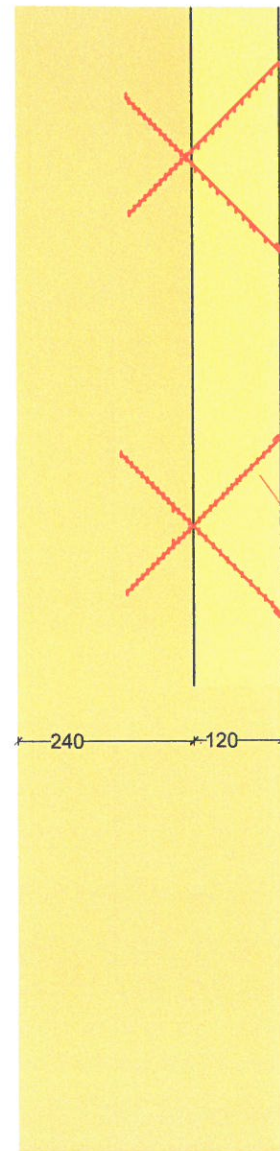

SH_F1_WW03a
 Würth Assy Plus VG
 10x360/332
 carbon steel
 cylinder head
 Art. No. 0165 310 360
 d=500mm
 (of crosses)

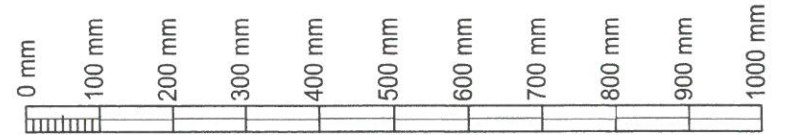
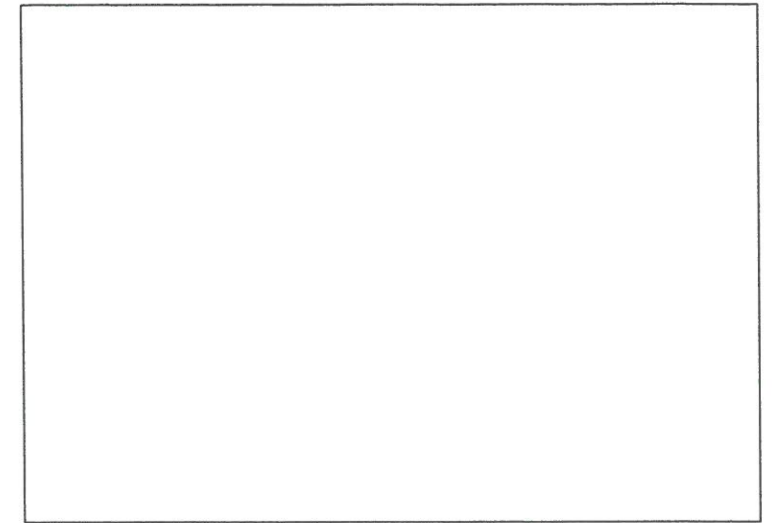

scale 1 : 10

ÚTGÁFA | SKÝRING | DAGS. | HANN. | YFIRF. | SAMÞ.

DAGS. UNDIRSKRIFTAR | BURÐARPOLSHÖNNUÐUR - SIGURÐUR UNNAR SIGURÐSSON KT. 290772-4279
 20.6.19 | Sig. U. Sig.

DAGS. UNDIRSKRIFTAR | NAFN OG KENNITALA SAMRÆMINGARHÖNNUÐAR
 20.6.19 | Sig. U. Sig.

HÖNNUÐUR | **KLH** | **KLH Massivholz GmbH**
 Gewerbestraße 4
 A-8842 Teufenbach-Katsch
 Tel. +43 (0) 3588/8835 - 0
 Fax +43 (0) 3588/8835 - 20
 E-Mail: office@klh.at

HEITI VERKS
FLATIR LÓÐ 9 - L208461
SKEIÐA- OG GNÚPVERJAHREPPI
FRÍSTUNDAHÚS

HEITI TEIKNINGAR
 Wall - Wall

VERKNÚMÉR | 2018 - 088 | DAGS. | 13.05.2019 | NR. TEIKNINGAR | D14

BLADSTÆRÐ: DIN A3

SH_F1_WCon1
Würth Assy 3.0
Ø 5.0x60mm
Art. No. 0153 350 60
30 screws / AB

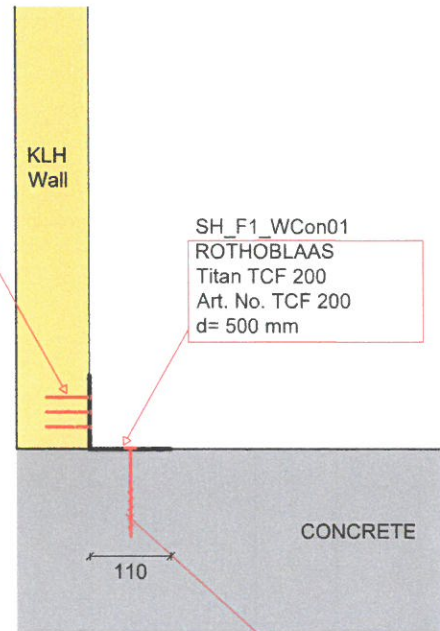

SH_F1_WCon1
RÖTHOBLAAS
Titan TCF 200
Art. No. TCF 200
d= 500 mm

SH_F1_WCon1
Rothoblaas SKR
Art. No. SKR 12140
2 dowels / AB
inside
12x140mm

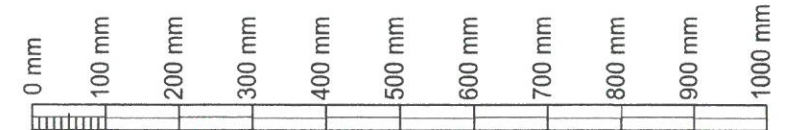

scale 1 : 10

ÚTGÁFA | SKÝRING | DAGS. | HANN. | YFIRF. | SAMÞ.

DAGS. UNDIRSKRIFTAR | BURÐARPOLSHÖNNUÐUR - SIGURÐUR UNNAR SIGURÐSSON KT. 290772-4279
 20.6.19 | Sig U. Sig

DAGS. UNDIRSKRIFTAR | NAFN OG KENNITALA SAMRÆMINGARHÖNNUÐAR
 20.6.19 | Sig U. Sig

HÖNNUÐUR
 **KLH Massivholz GmbH**
 Gewerbestraße 4
 A-8842 Teufenbach-Katsch
 Tel. +43 (0) 3588/8835 - 0
 Fax +43 (0) 3588/8835 - 20
 E-Mail: office@klh.at

HEITI VERKS
FLATIR LÓÐ 9 - L208461
SKEIÐA- OG GNÚPVERJAHREPPI
FRÍSTUNDAHÚS

HEITI TEIKNINGAR
 Wall - Concrete

VERKNÚMÉR 2018 - 088 | DAGS. 13.05.2019 | NR. TEIKNINGAR D15

BLAÐSTÆRD: DIN A3

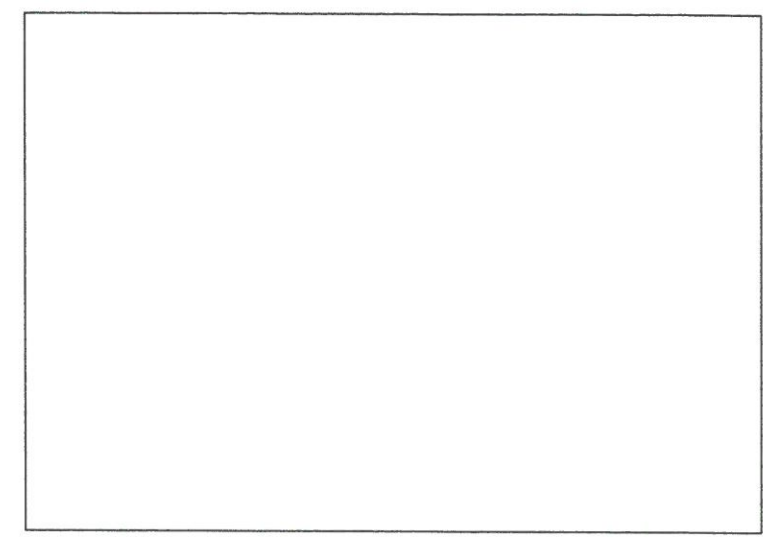
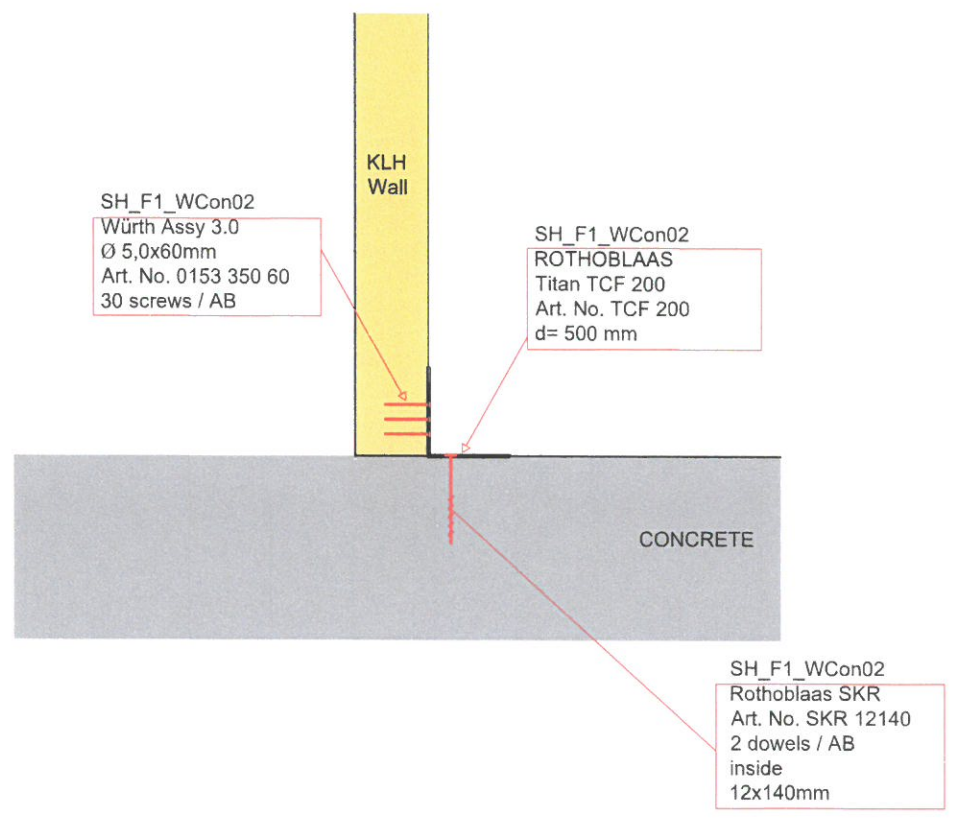

scale 1 : 10

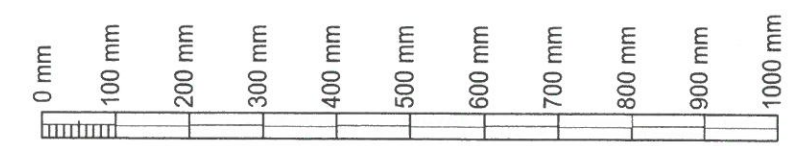

ÚTGÁFA		SKÝRING		DAGS.	HANN.	YFIRF.	SAMP.
DAGS. UNDIRSKRIFTAR		BURÐARPOLSHÖNNUÐUR - SIGURÐUR UNNAR SIGURÐSSON KT. 290772-4279					
20.6.19		Sig U. Sig					
DAGS. UNDIRSKRIFTAR		NAFN OG KENNITALA SAMRÆMINGARHÖNNUÐAR					
20.6.19		Sig U. Sig					
HÖNNUÐUR		 KLH Massivholz GmbH Gewerbestraße 4 A-8842 Teufenbach-Katsch Tel. +43 (0) 3588/8835 - 0 Fax +43 (0) 3588/8835 - 20 E-Mail: office@klh.at					
HEITI VERKS		FLATIR LÓÐ 9 - L208461 SKEIÐA- OG GNÚPVERJAHREPPI FRÍSTUNDAHÚS					
HEITI TEIKNINGAR		Wall - Concrete					
VERKNUMER	2018 - 088	DAGS.	13.05.2019	NR. TEIKNINGAR	D16		

BLADSTÆRÐ: DIN A3

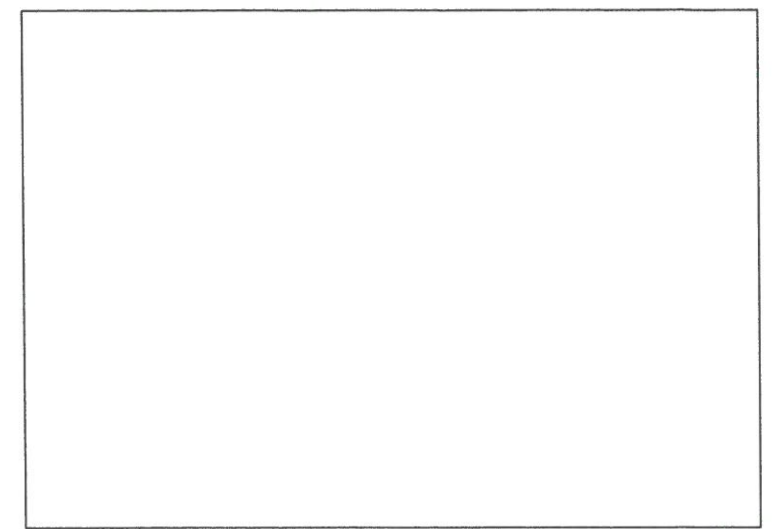
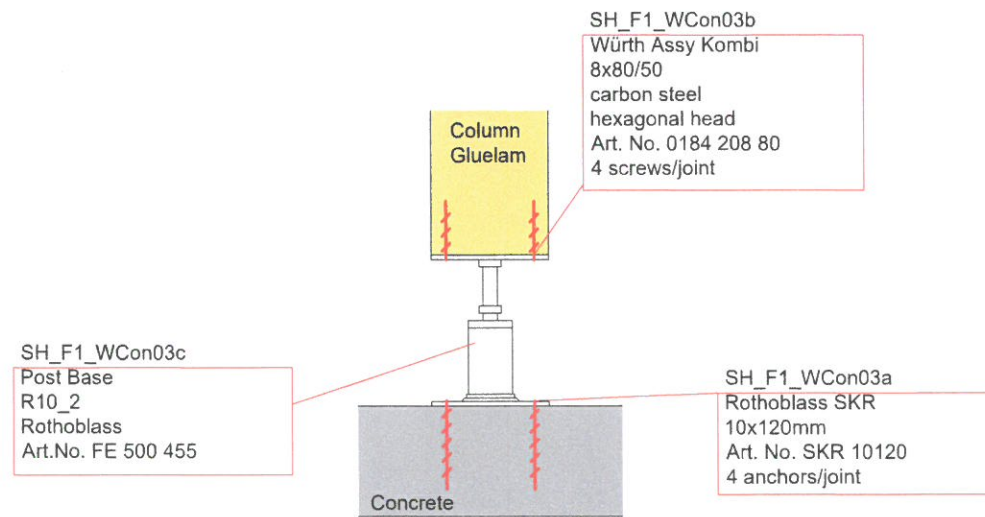

scale 1 : 10

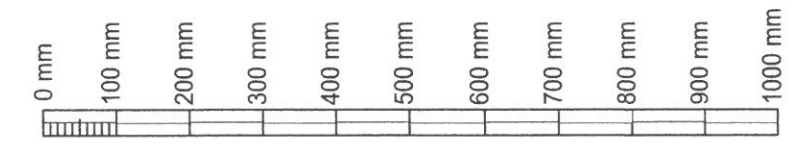

ÚTGÁFA | SKÝRING | DAGS. | HANN. | YFIRF. | SAMÞ.

DAGS. UNDIRSKRIFTAR | BURÐARPOLSHÖNNUÐUR - SIGURÐUR UNNAR SIGURÐSSON KT. 290772-4279

20.6.19 | Sig U. Sig

DAGS. UNDIRSKRIFTAR | NAFN OG KENNITALA SAMRÆMINGARHÖNNUÐAR

20.6.19 | Sig U. Sig

HÖNNUÐUR

KLH KLH Massivholz GmbH
 Gewerbestraße 4
 A-8842 Teufenbach-Katsch
 Tel. +43 (0) 3588/8835 - 0
 Fax +43 (0) 3588/8835 - 20
 E-Mail: office@klh.at

HEITI VERKS

**FLATIR LÓÐ 9 - L208461
 SKEIÐA- OG GNÚPVERJAHREPPI
 FRÍSTUNDAHÚS**

HEITI TEIKNINGAR

Wall - Concrete

VERKNÚMÉR 2018 - 088 | DAGS. 13.05.2019 | NR. TEIKNINGAR D17

BLADSTÆRÐ: DIN A3

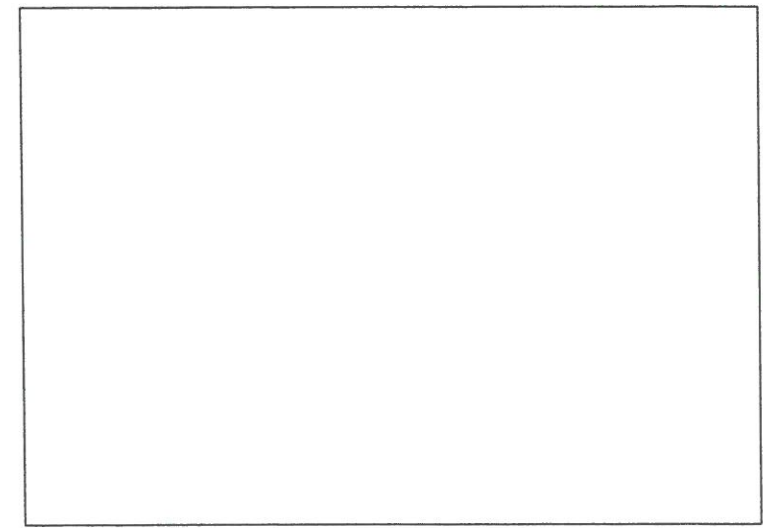
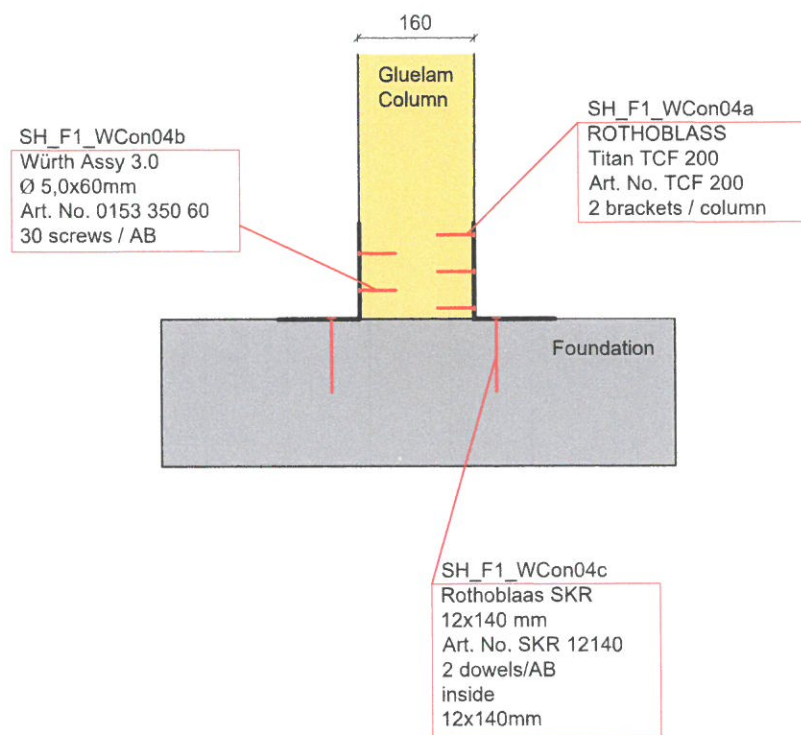

scale 1 : 10

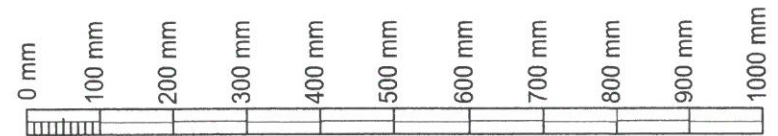

ÚTGÁFA | SKÝRING | DAGS. | HANN. | YFIRF. | SAMÞ.

DAGS. UNDIRSKRIFTAR | BURÐARPOLSHÖNNUÐUR - SIGURÐUR UNNAR SIGURÐSSON KT. 290772-4279
 20.6.19 | Sig U. Sig

DAGS. UNDIRSKRIFTAR | NAFN OG KENNITALA SAMRÆMINGARHÖNNUÐAR
 20.6.19 | Sig U. Sig

HÖNNUÐUR |  **KLH Massivholz GmbH**
 Gewerbestraße 4
 A-8842 Teufenbach-Katsch
 Tel. +43 (0) 3588/8835 - 0
 Fax +43 (0) 3588/8835 - 20
 E-Mail: office@klh.at

HEITI VERKS
FLATIR LÓÐ 9 - L208461
SKEIÐA- OG GNÚPVERJAHREPPI
FRÍSTUNDAHÚS

HEITI TEIKNINGAR
 Wall - Concrete

BLADSTÆRÐ: DIN A3

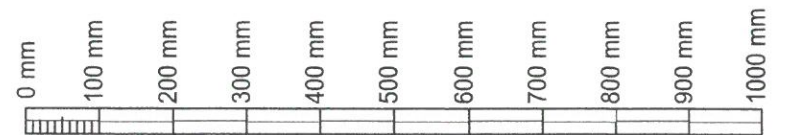
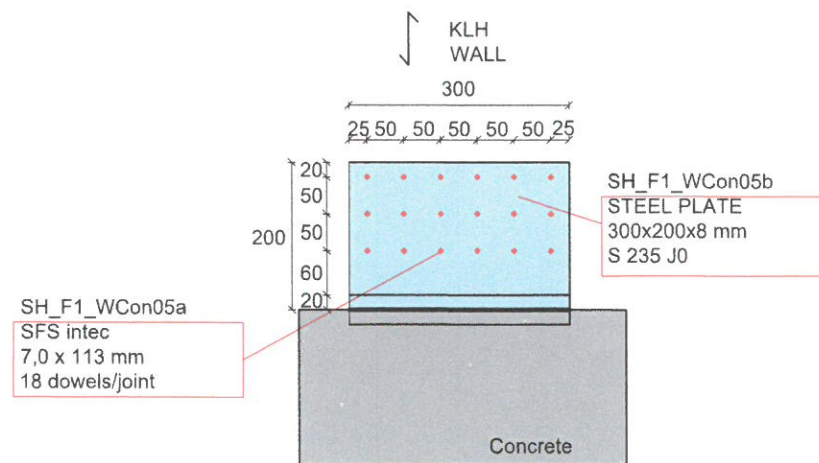
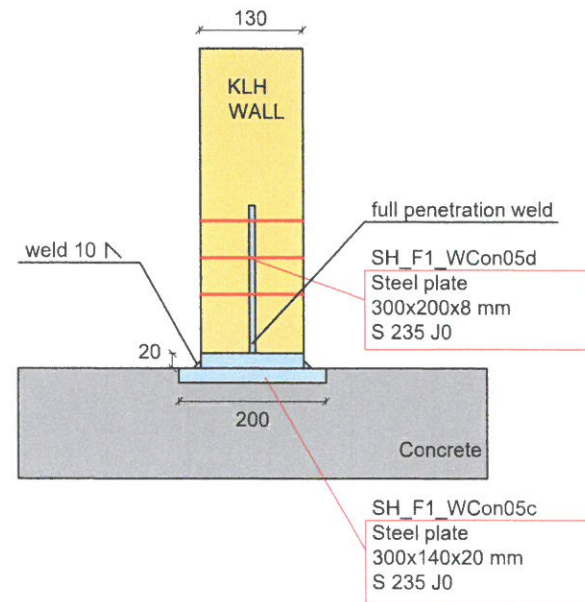

scale 1 : 10

ÚTGÁFA | SKÝRING | DAGS. | HANN. | YFIRF. | SAMP.

DAGS. UNDIRSKRIFTAR | BURÐARPOLSHÖNNUÐUR - SIGURÐUR UNNAR SIGURÐSSON KT. 290772-4279

20.6.19 | Sig. U. Sig.

DAGS. UNDIRSKRIFTAR | NAFN OG KENNITALA SAMRÆMINGARHÖNNUÐAR

20.6.19 | Sig. U. Sig.

HÖNNUÐUR

KLH KLH Massivholz GmbH
Gewerbstraße 4
A-8842 Teufenbach-Katsch
Tel. +43 (0) 3588/8835 - 0
Fax +43 (0) 3588/8835 - 20
E-Mail: office@klh.at

HEITI VERKS

FLATIR LÓÐ 9 - L208461
SKEIÐA- OG GNÚPVERJAHREPPI
FRÍSTUNDAHÚS

HEITI TEIKNINGAR

Wall - Concrete

VERKNÚMÉR 2018 - 088 | DAGS. 13.05.2019 | NR. TEIKNINGAR D19

BLAÐSTÆRÐ: DIN A3

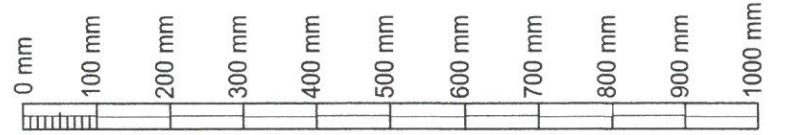
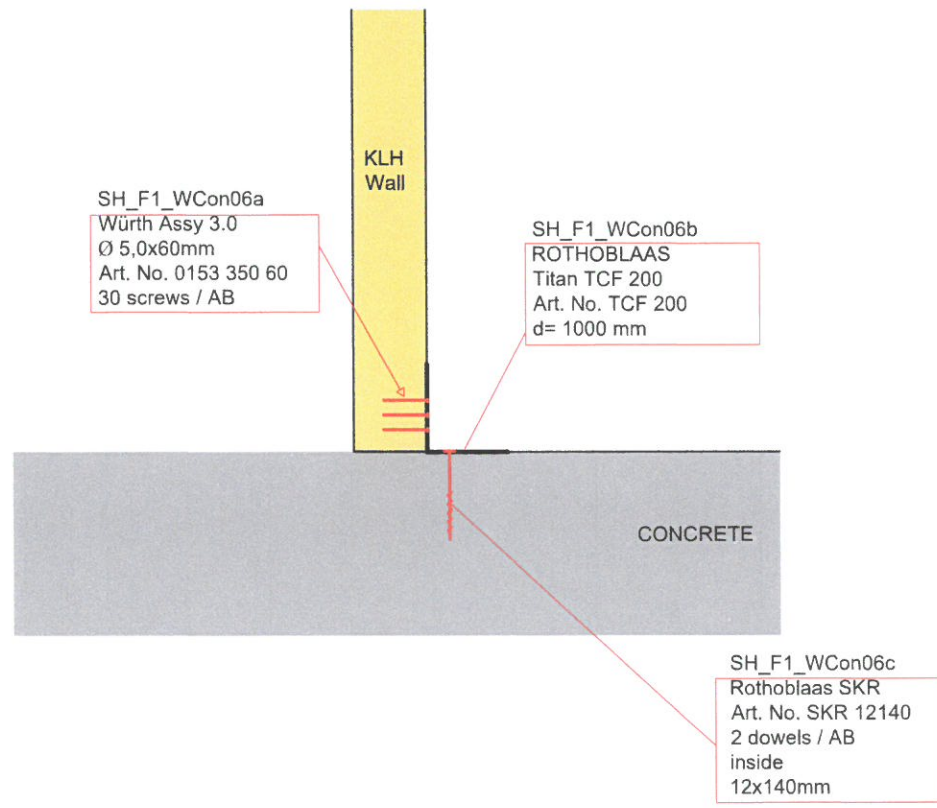

scale 1 : 10

DAGS. UNDIRSKRIFTAR		BURDARPOLSHÖNNUÐUR - SIGURÐUR UNNAR SIGURÐSSON KT. 290772-4279	
20.6.19		Sig U. Sig	
DAGS. UNDIRSKRIFTAR		NAFN OG KENNITALA SAMRÆMINGARHÖNNUÐAR	
20.6.19		Sig U. Sig	
HÖNNUÐUR		 KLH Massivholz GmbH Gewerbestraße 4 A-8842 Teufenbach-Katsch Tel. +43 (0) 3588/8835 - 0 Fax +43 (0) 3588/8835 - 20 E-Mail: office@klh.at	
HEITI VERKS			
FLATIR LÓÐ 9 - L208461 SKEIÐA- OG GNÚPVERJAHREPPI FRÍSTUNDAHÚS			
HEITI TEIKNINGAR			
Wall - Concrete			
VERKNÚMÉR		DAGS.	
2018 - 088		13.05.2019	
		NR. TEIKNINGAR	
		D20	

BLADSTÆRÐ: DIN A3

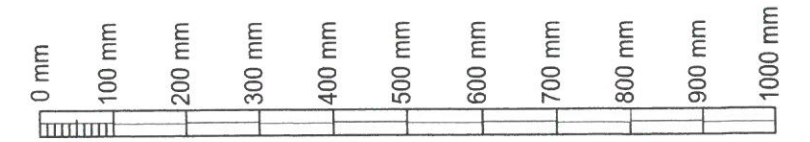
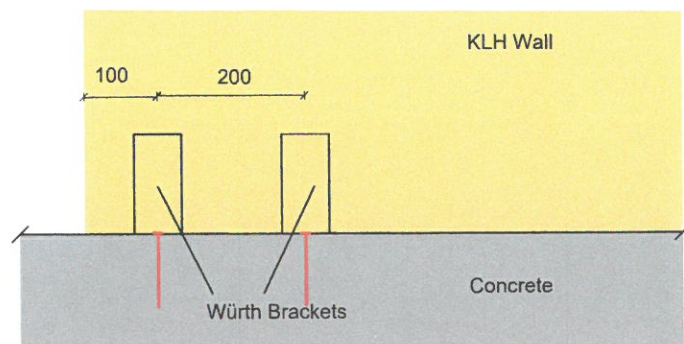
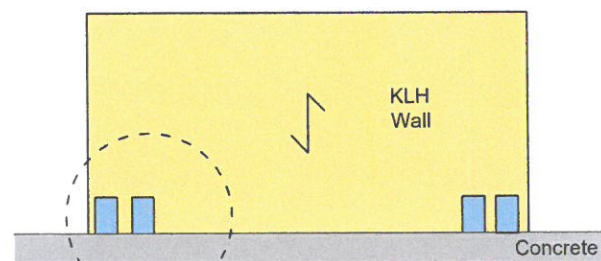
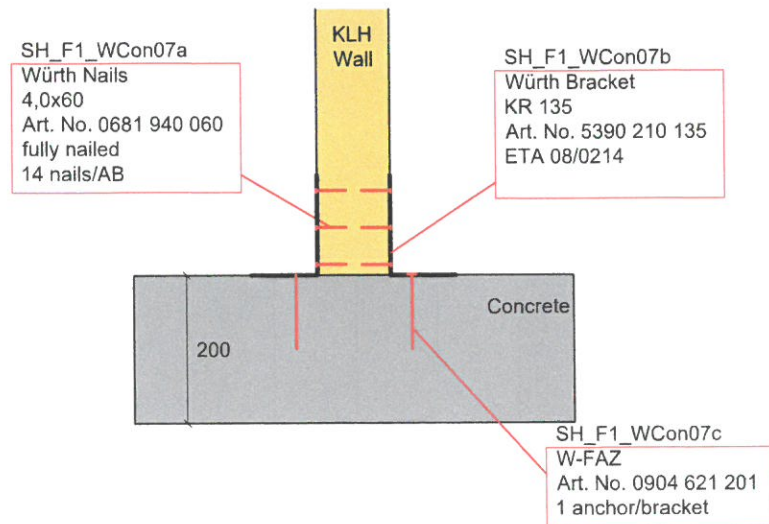

scale 1 : 10

ÚTGÁFA SKÝRING		DAGS.	HANN.	YFIRF.	SAMP.
DAGS. UNDIRSKRIFTAR	BURÐARPOLSHÖNNUÐUR - SIGURÐUR UNNAR SIGURÐSSON KT. 290772-4279				
20.6.19	Sig U. Sig				
DAGS. UNDIRSKRIFTAR	NAFN OG KENNITALA SAMRÆMINGARHÖNNUÐAR				
20.6.19	Sig U. Sig				
HÖNNUÐUR	 KLH Massivholz GmbH Gewerbestraße 4 A-8842 Teufenbach-Katsch Tel. +43 (0) 3588/8835 - 0 Fax +43 (0) 3588/8835 - 20 E-Mail: office@klh.at				
HEITI VERKS	FLATIR LÓÐ 9 - L208461 SKEIÐA- OG GNÚPVERJAHREPPI FRÍSTUNDAHÚS				
HEITI TEIKNINGAR	Wall - Concrete				
VERKNÚMÉR	2018 - 088	DAGS.	13.05.2019	NR. TEIKNINGAR	D21

BLADSTÆRÐ: DIN A3

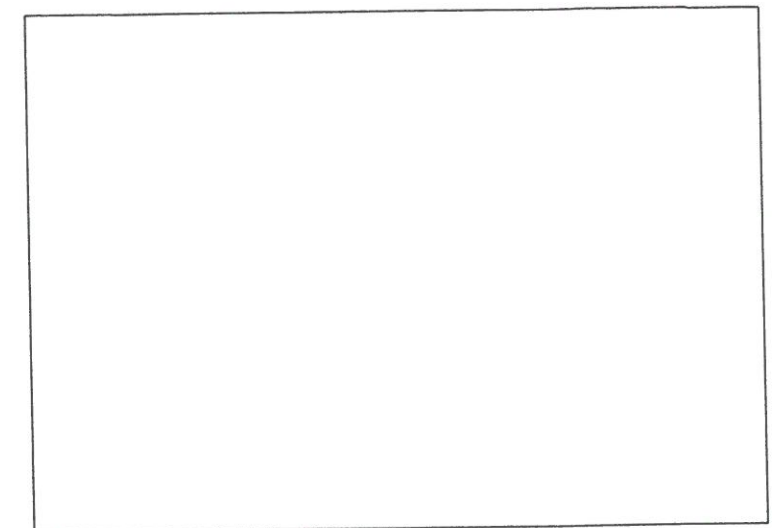
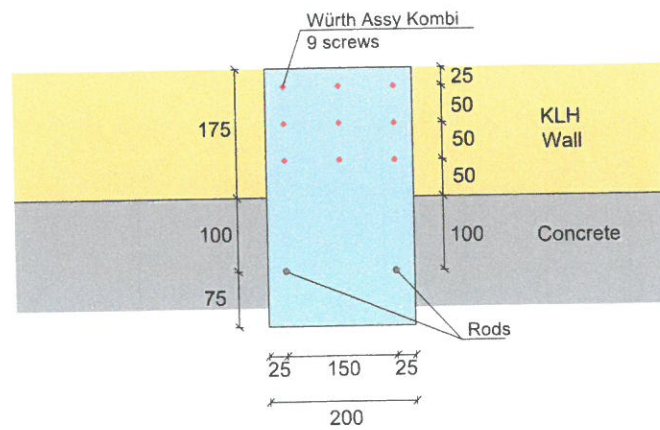
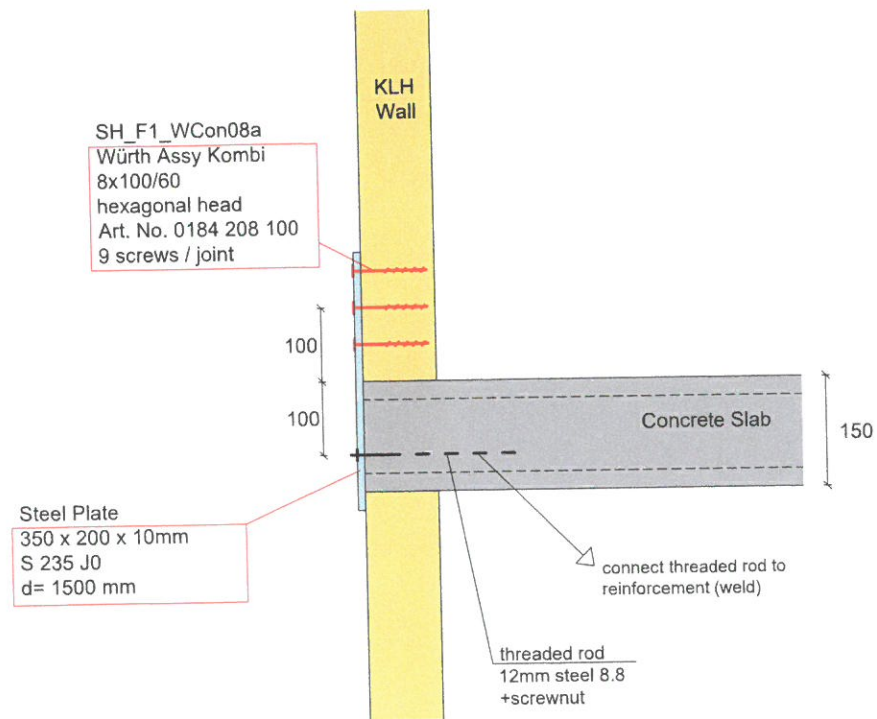

scale 1 : 10

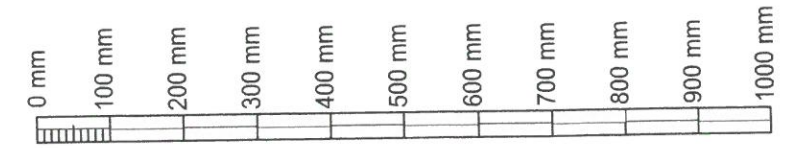

ÚTGÁFA SKÝRING	
<small>DAGS. UNDIRSKRIFTAR</small>	<small>BURÐARPOLSHÖNNUÐUR - SIGURÐUR UNNAR SIGURÐSSON KT. 290772-4279</small>
20.6.19	Sig U Sig
<small>DAGS. UNDIRSKRIFTAR</small>	<small>NAFN OG KENNITALA SAMRÆMINGARHÖNNUÐAR</small>
20.6.19	Sig U Sig
<small>HÖNNUÐUR</small>	<div style="display: flex; align-items: center;"> <div style="background-color: red; color: white; padding: 5px; font-weight: bold; margin-right: 10px;">KLH</div> <div> <p>KLH Massivholz GmbH</p> <p>Gewerbestraße 4</p> <p>A-8842 Teufenbach-Katsch</p> <p>Tel. +43 (0) 3588/8835 - 0</p> <p>Fax +43 (0) 3588/8835 - 20</p> <p>E-Mail: office@klh.at</p> </div> </div>
<small>HEITI VERKS</small>	
<p>FLATIR LÓÐ 9 - L208461</p> <p>SKEIÐA- OG GNÚPVERJAHREPPI</p> <p>FRÍSTUNDAHÚS</p>	
<small>HEITI TEIKNINGAR</small>	
Wall - Concrete	
<small>VERKNÚMÉR</small> 2018 - 088	<small>DAGS.</small> 13.05.2019 <small>NR. TEIKNINGAR</small> D22

BLADSTÆRÐ: DIN A3